

A
NOW INCORPORATED

Incider

THE APPLE II MAGAZINE

AN IDG COMMUNICATIONS PUBLICATION

A SLICE OF LIFE

Video Technology Adds That Personal Touch

APPLEWORKS PAGE LAYOUT

STOP THIEF! Is Your Apple Safe?

Reviews:

- Art & Film Director
- Cross-Works 1.3

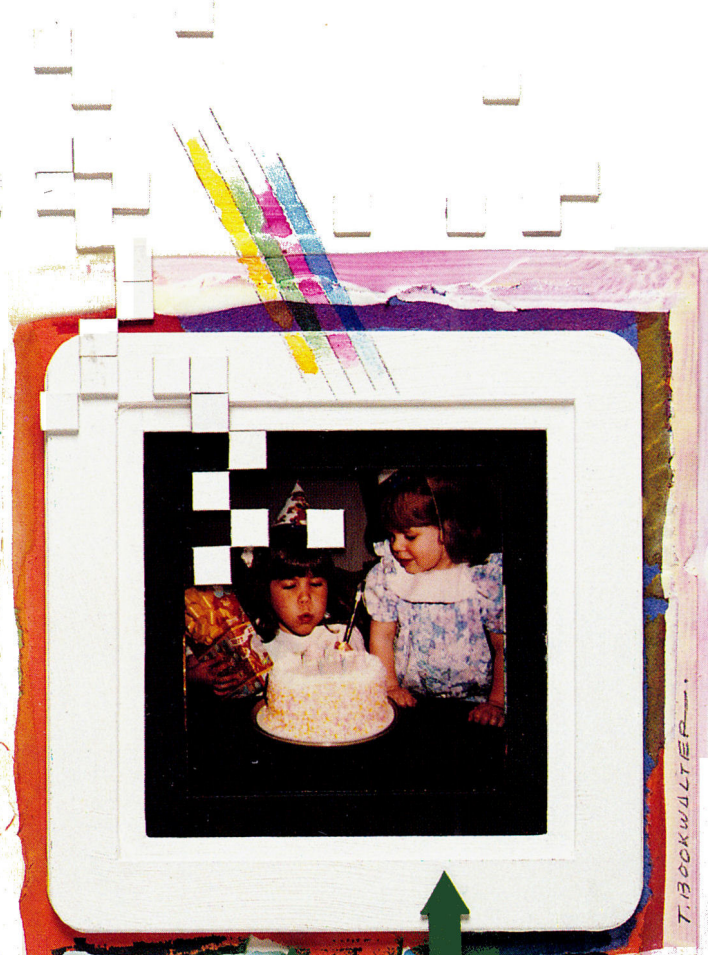

T. BOCKWALTER

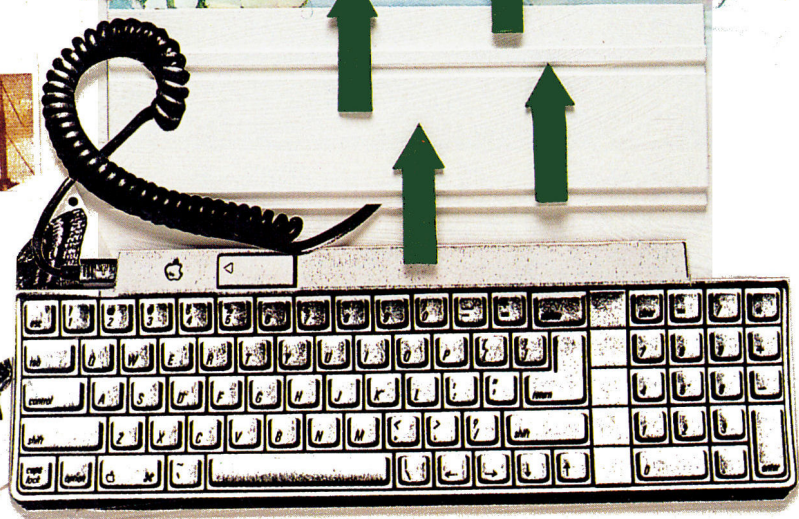

A

C

*****3-DIGIT 124
582020 NLS B0001J95
Dr. Kenneth Buchholz
www.Apple2Online.com
DEC 89
MLHM
#F6

The Games:
Summer Edition



Let Your Child Play With A Power Tool.



This is one power tool you'll be glad to put in your children's hands. While other kids compete for time on school computers, the LASER 128® enables yours to get ahead at home.

And what an advantage they get. The LASER 128 is Apple®-compatible, so your children gain access to the world's largest library of educational software. Plus thousands of other programs.

The LASER 128 puts you ahead, too. It sells for nearly a third less than an Apple with fewer features.

With savings like that, you can buy a monitor and a printer for a complete setup. And teach your child a

valuable lesson in getting more for your money.

How good of a computer will you get? Let's put it this way. The leading Apple magazine, *InCider*, suggests you "look at today's LASER if you want to see tomorrow's Apple."

Follow their advice. Call 312/540-8911 (in Canada 416/477-2818) for your nearest dealer. Or write LASER Computer, Inc., 550 E. Main Street, Lake Zurich, IL 60047.

Then let your children play with a real power tool. That is, when you're finished using it.

LASER
Laser Computer, Inc./A Video Technology Company

We turn Apple® Owners into Apple Users.

For only \$6.65 a month.

Softdisk™ is a monthly two-disk collection of valuable software for your Apple® II, II+, IIc, IIe, or IIgs.

Learn from the Experts!

Draw on the vast experience of our software editors to provide for you each month carefully-selected programs which you can use productively...from spreadsheets to accounting programs, from role-playing games to recipe programs, from home office to telecommunications programs. Using clearly-written documentation, you will master each new application with ease and confidence.

Become Experienced *Inexpensively!*

Without your investing a fortune, **Softdisk** will quickly demonstrate to you the full power and versatility of your Apple II. With its wide range of software, you will learn more about the capabilities of your computer than you ever thought possible. At only \$6.65 a month, **Softdisk** is your best software value!

Try **Softdisk** for Three Months!

Each month the latest issue of **Softdisk** will be delivered to your door on two unprotected 5¼" disks or one 3½" disk. Each disk is filled with great software, including utilities, games, home and business applications, and educational programs. Order now and receive **Softdisk Premium Graphics, Vol. 4** absolutely *free!*



Reviewers Love **Softdisk!**

"Boot the disk, and you're hooked! Every issue guarantees hours of adventure and fun. In a world where real bargains are hard to find, **Softdisk** is a very pleasant surprise..."

—Electronic Learning

Contents of Issue #89*

- **Asia**—Learn its countries and cities.
- **The Golden Cheese**—A treasure-filled maze to keep you mystified.
- **Finger Spell**—Learn to sign with the American Sign Language.
- **Expense Master**—Track your business expenses with this AppleWorks® template.
- **Tree**—Display the tree structure of your ProDOS® disk.
- **Print Shop® Graphics**—A new variety of images for your collection.

Plus ten more programs and features!

* Available as a back issue



Available at Waldenbooks, B. Dalton Booksellers, and fine bookstores everywhere at a cover price of \$9.95. ProDOS, AppleWorks, and Apple are trademarks of Apple Computer, Inc. Print Shop is a trademark of Broderbund Software.

FREE! **Softdisk Premium Graphics, Vol. 4*** when you place an order for the next three issues of **Softdisk** for your Apple II! Your bonus disk contains 200 graphic images, including:

- **Signs and Symbols**—Barber, Stop, Elevator...and more!
- **Animals**—Pig, Ram, Rhino, Dog, Cat, Buffalo...and more!
- **Sports**—Baseball, Basketball, Hockey, Olympic Events, and NBA Emblems...and more!
- **People**—Pilgrim, Cowboy, Hunter, Boy, Girl...and more!

Your Satisfaction Guaranteed!

If for any reason you are not satisfied with your purchase, return your first issue for a full \$19.95 refund. **Softdisk Premium Graphics, Vol. 4** is yours to keep. You just can't lose!

*Premium Graphics in 3½" format compatible only with Apple II GS.

YES! Please rush my free **Softdisk Premium Graphics, Vol. 4*** and start my three-month subscription to **Softdisk** for my Apple II for only \$19.95 postage paid. I understand that this offer is a **trial subscription** and that I am under no obligation to continue beyond three months. *Canada/Mexico \$24.95 • Overseas \$27.95*

• LA residents add 4% sales tax.

Check One: Two 5¼" disks One 3½" disk

Name _____

Street Address _____

City _____ State _____ Zip _____

Daytime Phone _____

Discover Visa/MC Am Ex Payment Enclosed (U.S. Funds)

Card# _____ Exp. date _____

Signature _____

Make check or money order payable to Softdisk Publishing.

Call Toll-Free 1-800-831-2694

SOFTDISK PUBLISHING P.O. Box 30008 • Shreveport, LA 71130-0008 • 318-221-8718 **IN079**

Circle 292 on Reader Service Card.

GET A NEW L

Beagle Unleashes Five New Products!



*The
Telecommunications
Solution for
AppleWorks Users!*

TimeOut TeleComm™

TimeOut TeleComm links AppleWorks to your modem. Now you can log on to your favorite information service right inside AppleWorks! TeleComm is simple to use, and since you stay in AppleWorks, there are no new editing commands to learn! You can even capture text directly into an AppleWorks word processor file.

TeleComm's flexible text sending features allow you to send any word processor file on the desktop. Keep your commonly used phone numbers in an AppleWorks database and TeleComm will dial the number for you. TeleComm can also send your login sequence when the connection is made.

TeleComm's wide selection of file transfer protocols insures you are supported by all information services. Operation can be set at speeds ranging from 300 to 19,200 Baud.

TeleComm supports all Hayes compatible AT command set modems and virtually all interface cards.

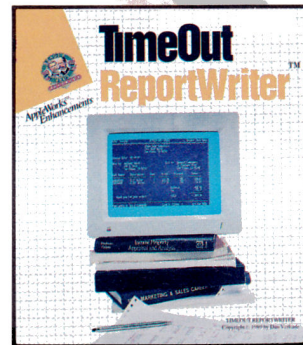

*Makes AppleWorks
a Powerful
Business Tool!*

TimeOut ReportWriter™

TimeOut ReportWriter is a relational report generator that turns AppleWorks into a powerful business tool. Invoices, billing forms, accounts receivable and accounts payable statements can be easily created. Teachers will love the flexibility of ReportWriter to create customized attendance records, report cards and form letters.

ReportWriter can use information from up to 11 data base, spreadsheet and word processor files at once. With 250 different categories and unlimited totals and sub-totals, ReportWriter gives you extremely comprehensive reports.

Gain total flexibility in your report design with ReportWriter's 240 column editor. Your reports will print out exactly how they look on the screen. You can easily create customized reports that fit perfectly into existing forms, print your mailing labels in multiple columns and a lot more.

Point-to-Point™

*The Professional
Communications
Program!*



EASH ON LIFE.

Point-to-Point, the award-winning Apple II communications program, is now published by Beagle Bros. InCider magazine voted Point-to-Point the "All Time Best Telecommunications Program" in 1988.

Simplify your communications with Point-to-Point's menu selectable features. And with the power of Point-to-Point's macros, you can completely automate your communications. Pre-set Point-to-Point to call any time you like, and Point-to-Point will dial, send or capture text, and then log off by itself.

Save money with Point-to-Point's elapsed time display feature. This handy function lets you know how long you have been on line.

Point-to-Point works on the Apple IIe, IIc, IIc+, and IIgs, and supports all Hayes Smartmodem-compatible modems, Hayes Micromodems, and the Novation Apple-Cat II.

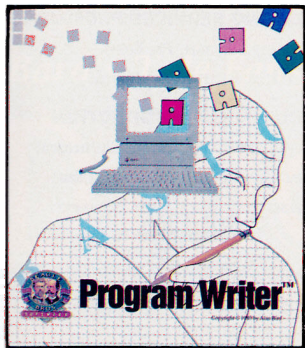

*The Indispensable
Basic Programming
Utility!*

Program Writer™

If you thought GPLE was good, you'll think Program Writer is fantastic! Program Writer's full screen editor makes writing Basic programs as easy as using a word processor. Edit anywhere on the screen. There's no need to continually re-list the file and trace over lines. You can even use the mouse to move the cursor!

Program Writer adds all these powerful functions: Insert, Delete, Find, Search, Replace, Cut and Paste. And with Program Writer's Auto-number and Re-number commands, you'll never need to enter another line number again! Program Writer's macro capability lets

you enter commonly used strings like "PRINT" or "GOTO" with one key press. It's like adding function keys to your Apple! Program Writer works on the Apple IIe, IIc, IIc+ and IIgs in both DOS 3.3 and ProDOS.

*Design your own
IIgs System
Fonts!*

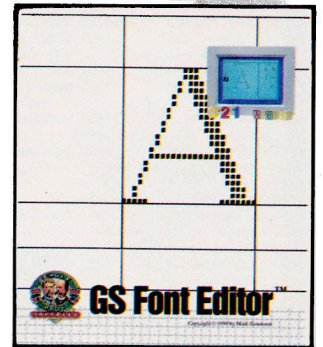

GS Font Editor™

Now you can customize the fonts used by your favorite IIgs word processor, page layout, and graphics programs. You can also edit the fonts used by Beagle Bros' TimeOut SuperFonts and TimeWorks' Publish It!

While you are editing, GS Font Editor displays each character in normal, underline, italic, outline, boldface, and shadow styles. Have fun creating foreign language fonts or designing customized picture fonts of anything you can imagine.

GS Font Editor can also scale your fonts from one size to any other - up to 127 point in size! Best of all, GS Font Editor is mouse-driven, so it's fast and easy to use. GS Font Editor works on the IIe, IIc, IIc+ and IIgs.

**UNLEASH
THE
POWER.**



Circle 179 on Reader Service Card.

Call 1-800-345-1750 in the U.S. or
1-800-992-4022 in California to order.

ZIMCO

INTERNATIONAL, INC.

85-39 213 St., Queens Village, NY 11427

FREE SHIPPING*
ON ALL ORDERS

COMPUTERS

| | |
|-----------------------------|-------|
| LASER 128 Computer | \$365 |
| LASER 128EX Computer | \$423 |
| GENUINE APPLE: | |
| Apple IIc+ CPU | \$534 |
| Apple IIe CPU | \$656 |
| Apple IIGS | \$885 |
| Apple MacPlus, SE, II, IIfx | call |

DRIVES

| | |
|---|--------|
| Genuine Apple 3.5", 800K drive (IIGS/Mac) | \$335 |
| Apple UniDisk 3.5 w/Catalyst | \$336 |
| Applied Engineering with a 1 year warranty 5.25" drive Controller | \$111 |
| Genuine Apple 5.25" drive Fortite IIGS | \$260 |
| Harddisk 208C | \$711 |
| Harddisk 408C | \$1028 |
| CENTRAL POINT 3.5" Drive Controller | \$69 |
| CMS Stack Drive for IIGS/SD20-A2S | \$650 |
| SD23-A2S | \$815 |

| | |
|-------------------|--------|
| 20 Plus ext. IIGS | \$665 |
| 40 Plus ext. IIGS | \$999 |
| 60 Plus ext. IIGS | \$1200 |

RODIME

| | |
|-------------------|--------|
| 20 Plus ext. IIGS | \$665 |
| 40 Plus ext. IIGS | \$999 |
| 60 Plus ext. IIGS | \$1200 |

HARDWARE

| | |
|-------------------------|-------|
| GENUINE APPLE: | |
| Apple IIc MOUSE | \$79 |
| Apple IIe MOUSE | \$119 |
| Apple IIe enhance. kit | \$59 |
| Apple IIe mem.exp.ccd. | \$182 |
| Apple IIe 256k exp. kit | \$125 |
| Apple Numeric Keypad | \$55 |
| Apple SCSI card | \$119 |
| Apple Super Serial Card | \$110 |

| | |
|-----------------------------|--------|
| APPLIED ENGINEERING: | |
| 16 Channel 12-bit A/D | \$205 |
| Buffer Pro 32K | \$82 |
| Buffer Pro 256K | \$179 |
| BM Keyboard w/cable | \$104 |
| PC Transporter 768K | \$491 |
| PC Transporter Inst. II+IIe | \$29 |
| PC Transporter Inst. IIGS | \$37 |
| Parallel Pro | \$72 |
| Phasor | \$124 |
| Pocket Rocket 16K II+ | \$74 |
| RamCharger | \$131 |
| RGB Colorlink | \$96 |
| Ramfactor w/0K | \$141 |
| Ramfactor w/256k | \$183 |
| Ramfactor w/512k | \$285 |
| Ramfactor w/1 Meg | \$528 |
| Ramfactor exp. w/0K | \$149 |
| Ramfactor Exp. w/1 M. | \$485 |
| Ramfactor Exp. w/2 M. | \$822 |
| Ramfactor Exp. w/3 M. | \$1158 |
| Ramfactor Exp. w/3 M. | \$1494 |
| RamKeeper | \$138 |
| Ramworks 0K | \$90 |
| Ramworks w/64 | \$164 |
| Ramworks w/256k | \$171 |
| Ramworks w/512k | \$276 |
| Ramworks 2 Meg. exp. card | \$822 |
| w/1 Meg... \$485 w/2 Meg | \$822 |
| Ramworks III w/0K | \$104 |
| Ramworks III w/256k | \$179 |
| Ramworks III w/512k | \$285 |
| Ramworks III w/1 Meg | \$491 |
| Ramworks III w/1.5 Meg | \$737 |
| Ramworks III w/2 Meg | \$1307 |
| RGB Digital Prism | \$97 |
| Serial Pro | \$104 |
| TimeMaster II H.O. | \$72 |
| Transdrive Single | \$194 |
| Transdrive Double | \$298 |
| Transwrap IIe | \$125 |
| Transwrap 80 II+ | \$119 |
| Z-80 Plus | \$111 |
| Z-80C | \$119 |
| Z-Ram 16-bit chip | \$59 |
| Z-RAM ULTRA 1 w/0K | \$104 |
| Z-RAM ULTRA 1 w/256k | \$186 |
| Z-RAM ULTRA 1 w/512k | \$291 |
| Z-RAM ULTRA 2 w/0K | \$156 |
| Z-RAM ULTRA 2 w/256k | \$238 |
| Z-RAM ULTRA 2 w/512k | \$338 |
| Z-RAM ULTRA 2 w/1 M. | \$552 |
| Z-RAM ULTRA 3 w/0K | \$216 |
| Z-RAM ULTRA 3 w/256k | \$298 |
| Z-RAM ULTRA 3 w/512k | \$403 |

| | |
|------------------------------|-------|
| Z-RAM ULTRA 3 w/1 M. | \$612 |
| APLUS MOUSE IIGS | \$79 |
| CH Flightstick | \$48 |
| CH Moch II Joystick IIGS/II+ | \$38 |
| Extended 80 col. for IIGS | \$29 |
| Fan & Surge Prot. | \$29 |
| JOYSTICK for IIGS/II+ | \$26 |
| Kennington System Saver | \$42 |
| KOALA Pad Plus | \$86 |
| KRAFT 3-but. joystick | \$30 |
| LASER 128 Mouse | \$55 |
| LASER 128K cables | \$21 |
| Lower Case ROM II+ only | \$19 |

MONITORS

| | |
|-----------------------------|-------|
| APPLE Color Comp. | \$316 |
| APPLE Monochrome | \$126 |
| APPLE RGB Analog GS | \$475 |
| Amber or Green Mono | \$110 |
| MAGNA VOX Amber/Green \$110 | |
| MAGNA VOX RGB 14" | \$299 |

PRINTERS

| | |
|---------------------------|--------|
| APPLE Imagewriter 32K Op. | \$80 |
| Imagewriter II | \$465 |
| Imagewriter LQ | \$1080 |
| LASERWRITER IIINT | \$3955 |
| LASERWRITER IISC | \$2200 |
| LASERWRITER IIINTX | \$5826 |
| CITIZEN 1200 | \$173 |
| MSP-15 | \$401 |
| EPSON LX800 | \$205 |
| LQ500 | \$360 |
| LQ800 | \$410 |
| FX850 | \$375 |
| PANASONIC | |
| KXP-1180 | \$185 |
| KXP-1191i | \$243 |
| KXP-1124 | \$327 |
| Panasonic Laser 4450 | \$1785 |
| STAR NX-1000 Parallel | \$185 |
| NX-1000 Rainbow | \$235 |
| TOSHIBA P321St. | \$558 |

SOFTWARE

| | |
|-----------------------|------|
| ACTIVISION | |
| Beyond Zork | \$30 |
| Zork Trilogy | \$30 |
| Zork Zero | \$30 |
| Rampage (or) Shanghai | \$22 |

| | |
|-----------------------------|-------|
| TASS TIME IN TONETOWN | \$25 |
| To Heir Is Human | \$30 |
| Webster's Spell (Sm & Sch.) | \$37 |
| WORDPERFECT IIGS e.c. | \$95 |
| WORDSTAR 2X (MicroPro) | \$175 |

SOFTWARE FOR THE IIGS!

| | |
|-----------------------------------|-------|
| (Please ask for the IIGS version) | |
| DELUXE PAINT | \$73 |
| GRAPHIC WRITER | \$109 |
| HACKER | \$26 |
| INSTANT MUSIC | \$37 |
| LEARNING CO. | |
| Reader Rabbit GS | \$37 |
| Writer Rabbit GS | \$30 |
| Magic Spells GS | \$25 |
| Math Spills GS | \$26 |
| Mastertricks MIDI | \$170 |

| | |
|---------------------|------|
| MICROPROSE | |
| Silent Service GS | \$25 |
| Pirates GS | \$26 |
| MINDSCAPE | |
| Defender o.t. Crown | \$31 |
| King of Chicago GS | \$31 |
| SDI | \$31 |
| Papertoy | \$25 |
| Gauntlet | \$25 |
| MIGHT & MAGIC | \$34 |
| MUSIC CONSTRUCTION | \$38 |
| MUSIC STUDIO | \$54 |
| NEWSMAKER | \$55 |
| PAINTWORKS PLUS | \$54 |

| | |
|----------------------------|------|
| PBI Software | |
| Sea Strike GS | \$24 |
| Monte Carlo GS | \$24 |
| Tower of Myrlogan GS | \$31 |
| Alien Mind GS | \$31 |
| Visualizer GS | \$54 |
| Pinpoint IIGS Starter Pack | \$97 |
| PRINT SHOP | \$36 |
| Random Hs. II Write GS | \$49 |
| Roger Wagner | |
| Mousewrite GS | \$90 |
| Softswitch GS | \$38 |
| SPECTRUM HOLOBYTE | |
| Galb | \$25 |
| Orbit | \$33 |
| Wilderness | \$31 |

| | |
|----------------------------|-------|
| SIERRA ONLINE | |
| King's Quest 1/2/3GS | @\$30 |
| Leisure Suit Lory GS | \$26 |
| Space Quest IIGS | \$31 |
| Softview Taxview GS | \$64 |
| Talking Textwriter GS | \$150 |
| TOP DRAWER GS | \$54 |
| Typing Tutor IV GS | \$30 |
| WORDPERFECT GS | \$95 |
| Writer's Choice Elite IIGS | \$54 |

IIGS HARDWARE

| | |
|--------------------------------------|--------|
| APPLE IIGS Computer | \$885 |
| Apple IIGS mem.exp. | \$182 |
| Applied Engineering: | |
| Colorlink GS/Analog | \$97 |
| GS-RAM 0K | \$81 |
| GS-RAM 256k | \$161 |
| GS-RAM 512k | \$263 |
| GS-RAM 1Meg | \$464 |
| GS-RAM 1.5Meg | \$687 |
| GS-RAM Plus 1 Meg | \$439 |
| GS-RAM Plus 2 Meg | \$770 |
| GS-RAM Plus 3 Meg | \$1121 |
| GS-RAM Plus 4 Meg | \$1457 |
| PC Trans. Inst. IIGS | \$37 |
| NEW from Applied Engineering: | |
| SONIC BLASTER GS | \$94 |
| TRANSWARP GS | \$293 |
| Kennington Sys.Saver IIGS | \$79 |
| KURTA IS GS Digitizing Tablet | |
| w/ stylus | \$299 |
| Joystick for IIGS | \$24 |
| MDIDEAS | |
| Conservator IIGS | \$124 |
| Professional Digitizer | \$139 |
| Supersonic (Stereo) | \$59 |
| Supersonic Digitizer | \$59 |
| ORANGE MICRO | |
| Juice Box GS | \$62 |
| Graffiti oMac GS | \$84 |
| Street ELEC. Echo IIGS | \$239 |
| he/h/GS | \$122 |
| SUMMAGRAPHICS | |
| Bit Pad Plus ADB IIGS | \$329 |

LASER 128EX \$423

IMAGEWRITER II \$465

Hayes Compatible Modem 300/1200 bps w/ cable \$149

NEW SONIC BLASTER \$94

NEW TRANSWARP GS \$293

Remember, If You Don't See It Here, CALL US for Anything Apple, MAC, or IBM.

DISKETTES 10 3.5" DS/DD \$21

3.5" Cleaning Kit \$25

Disk Storage 100 \$15

MIDI

| | |
|---------------------------------------|-----------|
| Mastertricks IIGS | \$170 |
| SONIUS Super Sequencer | \$197 |
| Sonus Pars. Musician IIGS | \$87 |
| PASSPORT Polywriter | \$205 |
| Passport Music Tutor | \$159 |
| Passport Voice Librarians | call |
| Apple MIDI INTERFACE | \$89 |
| PASSPORT MIDI INTERFACE w/typecch | \$135 |
| MODEMS | |
| ANCHOR Auto 1200E | \$89 |
| ANCHOR Auto 2400E | \$158 |
| Signatrim Light 2400 | \$292 |
| APPLE Personal Modem | \$221 |
| APPLIED ENGINEERING: | |
| DATALINK 300/1200bps int. for IIGS/CS | \$159 |
| DATALINK 1200 | \$134 |
| DATALINK 2400 | \$179 |
| HAYES MODEMS: | |
| Macromodem IIGS | \$164 |
| Smartmodem 1200 Ext. | \$325 |
| Smartmodem 2400 Ext. | \$467 |
| PRACTICAL PERIPHERALS: | |
| 1200SA | \$99 |
| 2400SA | \$203 |
| PROMETHEUS AND | |
| US ROBOTICS | CALL |
| Modem Cables | from \$21 |

| | |
|------------------------------|------|
| The Last Ninja | \$22 |
| BRODERBUND | |
| Ancient Art of War | \$29 |
| Bank Street Writer 64K | \$42 |
| Bank Street Writer Plus | \$48 |
| CARMEN SAN DIEGO! | |
| Where in Europe | \$28 |
| Where in the USA | \$24 |
| Where in the World | \$28 |
| Dazzle Draw | \$36 |
| Print Shop w/Graphics lib. | \$31 |
| Graphics Libraries | \$15 |
| Disk 1/2/3/ Holidays | \$20 |
| DAVIDSON | |
| Alge-Blastor | \$27 |
| Reading and Me | \$22 |
| Math Blaster (or) M/B Plus | \$27 |
| SpellIt | \$27 |
| Word Attack (or) W/A Plus | \$27 |
| ELECTRONIC ARTS | |
| Bard's Tale | \$28 |
| Bard's Tale 2 (or) 3 | \$34 |
| Chessmaster 2000 | \$25 |
| Hunt for Red October | \$31 |
| Scraples | \$25 |
| EPYX | |
| "THE GAMES" Winter | \$30 |
| "THE GAMES" Summer | \$30 |
| California Games | \$24 |
| Impossible Mission II | \$24 |
| Rampoc | \$30 |
| SIRTECH Wizardry | \$30 |
| Legacy of Ulygamyn | \$37 |
| Return of Werdna | \$37 |
| Star Trek II (Sm. & Schus.) | \$25 |
| SubLogic Flight Simulator II | \$32 |

No EXTRA CHARGE
DISCOVER · VISA · MASTERCARD

1-800-227-6647 Orders Only.
For All Inquiries, Tech Support & NY:
Call 718-479-7888

Free shipping via UPS/USPS ground within the continental U.S. *Add insurance and handling fee to all orders. We cannot guarantee prices or weather; both tend to change. Call for current prices & sale flyer. Min. restocking fee 20%. No returns without prior authorization. (InCider, A, Plus 7/89)

PUBLISHER Paul Boule
EDITOR IN CHIEF Dan Mue
MANAGING EDITOR Eileen T. Terrill
SENIOR EDITOR Paul Statt
TECHNICAL EDITOR William Kennedy, Ph.D.
REVIEW EDITOR Lafe Low
COPY EDITOR Ellen Ratner Otis
EDITORIAL ASSISTANT Janet Cote
WEST COAST EDITOR Jeff Cable
CONTRIBUTING EDITORS Joe Abernathy
Cynthia E. Field, Eric Grevstad, Scott Mace
Tom Sherman, Ruth K. Witkin
FIELD EDITOR Babe Cringely

DESIGN
ART DIRECTOR Linda Sweeney
SENIOR DESIGNER/AD GRAPHICS Dianne K. Ritson
PRODUCTION MANAGER/DESIGNER Varvara Auer

ADVERTISING
ASSOCIATE PUBLISHER Dale Strang
NATIONAL SALES MANAGER (800) 441-4403
NORTHEAST SALES REPRESENTATIVE Peter Slingluff
(800) 441-4403
WESTERN SALES REPRESENTATIVE James Burns
3350 W. Bayshore Rd.
Suite 201
Palo Alto, CA 94303
(415) 328-3470
NORTHWEST SALES REPRESENTATIVE Janet Wright
(415) 328-3470

MARKETPLACE/CLASSIFIEDS Fiona Davies
SALES REPRESENTATIVE (800) 441-4403
ADVERTISING COORDINATOR Mary Hartwell
(800) 441-4403
ADMINISTRATIVE ASSISTANT Carmen Bryer
WESTERN SALES ASSISTANT Kathleen Roberts

MARKETING SERVICES/PROMOTION
MARKETING MANAGER Peg Brown
MARKETING ASSISTANT Rita Rivard

CORPORATE PRODUCTION
DIRECTOR OF CORPORATE PRODUCTION Dennis Christensen
MANUFACTURING MANAGER Leslie A. Walden
TYPESETTING MANAGER Lindy Palmisano
TYPOGRAPHER Heidi N. Thomas

IDG COMMUNICATIONS/PETERBOROUGH
PRESIDENT/CEO Roger Murphy
EXECUTIVE VICE PRESIDENT Stephen Twombly
SINGLE-COPY SALES DIRECTOR Linda Ruth
MARKETING MANAGER/SINGLE-COPY SALES Michael P. Carroll (800) 343-0728
NEWSSTAND PROMOTION MANAGER Debbie Walsh
CIRCULATION DIRECTOR, INCIDER Megan Lane (800) 289-0619
ASSISTANT CIRCULATION MANAGER, INCIDER Laurie K. Seamans
DIRECTOR OF CREDIT, SALES, William M. Boyer
AND COLLECTION
AUDITS AND STATISTICS Cecile Giguere
FOUNDER Wayne Green



inCider's DBS (bulletin-board system) on line 24 hours: (603) 924-9800

inCider (ISSN #0740-0101) is published monthly by IDG Communications/Peterborough, Inc., 80 Elm Street, Peterborough, NH 03458. Phone: (603) 924-9471. Second-class postage paid at Peterborough, NH, and additional mailing offices. (Canadian second class mail registration number 9590.) Subscription rates in U.S. are \$27.97 for one year, \$43.00 for two years and \$59.00 for three years. In Canada, \$34.97, U.S. funds, one year only. In Mexico, \$52.97—one year only, U.S. funds drawn on a U.S. bank. Nationally distributed by International Circulation Distributors. Foreign subscriptions (surface mail), \$47.97—one year only, U.S. funds drawn on a U.S. bank. Foreign subscriptions (air mail), \$82.97 prepaid, U.S. funds drawn on U.S. bank, one year only. Postmaster: Send address changes to inCider, Subscription Services, P.O. Box 58618, Boulder, CO 80522-8618. (Send Canadian changes of address to: inCider, P.O. Box 1051, Fort Erie, Ontario L2A 5N8.)



Bard's Tale Fans, Rejoice!

Dragon Wars™

The designers of the Bard's Tale™ series, Wasteland™ and Battle Chess™ wanted to pool their talents to create the ultimate role-playing fantasy. They knew it had to be a first rate story with state-of-the-art animated graphics. The result was Dragon Wars.

King Drake of Phoebus has declared all magic illegal – magickers have been slain or fled into exile. In retaliation, enemy islands have threatened to unleash their dragons – beasts who are the most destructive force in Oceana. Docked at a harbor in Dilmun, you are arrested on suspicion of spellcasting.

Imprisoned and stripped of everything but your wits, you are sentenced to life in a dungeon. Magic is your only salvation – a worldly possession in a world possessed.

- Over 60 monsters and 65 spells.
- Supports characters from Bard's Tale I, II, III.
- A unique combat system: choose complexity of combat resolution, determine spell strength, select tactics of ranged combat.
- An easy to use pop-up window system.
- Save the game anywhere.
- A paragraph book to enhance storytelling.
- No graph paper needed.

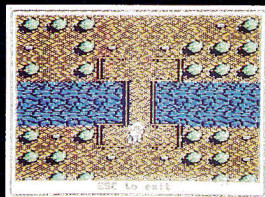

Feeling lost? Auto-map keeps track of your every move.



Graphics so real you can see the croc's scales ripple with his every breath.



Don't just stand around. There are so many secrets to uncover.

ACTUAL APPLE IIe SCREENS



Interplay Productions
1575 Corporate Drive
Costa Mesa, CA 92626
(714) 549-2411

To order Dragon Wars, 1-800-227-6900
Available on the Apple IIe/c with 128K.
Coming soon for C64 & MS-DOS.

Bard's Tale & Wasteland are trademarks of Electronic Arts.
Dragon Wars & Battle Chess are trademarks of Interplay Productions.
Commodore is a trademark of Commodore Business Computers.
Apple is a trademark of Apple Computer, Inc.



INCIDER'S VIEW

THE ART OF TECHNOLOGY

By DAN MUSE + EDITOR IN CHIEF

What has made digitization suddenly attractive to pragmatists like you and me is desktop publishing.

DID YOU LOOK AT THIS MONTH'S COVER and say, "Digitizers and scanners are interesting technologies, but what can you really do with them?"

That's not an unreasonable question. The practicality of products such as Color ComputerEyes, ThunderScan, and the Apple II Video Overlay Card isn't obvious to the typical Apple II user. I know, because for a long time it wasn't obvious to me.

What has made digitizers suddenly attractive to pragmatists like you and me is *desktop publishing*. Before programs like Publish It!, Springboard Publisher, and Personal Newsletter emerged, there wasn't much you could do with that digitized dog or scanned Siamese. The hardware was fun to play with, but did you really want a digitized picture of your family on the wall in place of a photograph? Sophisticated technological design is good design only if it serves a useful purpose.

Desktop publishing is the perfect vehicle for digitization. Digitized illustrations add a personal touch to your newspapers, newsletters, flyers, brochures, and so on. While clip art is great for some things, it's only what its name implies—pieces of art clipped from a variety of sources. Because it's available to every Apple II user, you always risk the chance that your publication will look unoriginal. You also have no guarantee that you'll find clip art that's appropriate for your subject—your scuba-diving club's newsletter, for instance.

If you rely on clip art, you rely on someone else's definition of good artwork. While most clip art is well done, it simply can't convey that personal slant that makes your work unique.

If I write a newsletter about obedience training for dogs, I want to use my dog or a friend's dog on the front page. Why use a canned generic dog from a clip-art disk, when I can scan a photo of Paul Statt's black-and-white border collie, Ben? Ben's no Lassie, but his coloring makes him an ideal candidate for gray-scale digitization. Or if I send a bulletin to members of my softball team, why use clip art of a bat and a ball when I have

piles of photos of team members that add a personal touch to my publication?

Digitizers and scanners also make you self-sufficient. To alter an adage: Give a man a clip-art disk and he publishes for a day; teach him to digitize and he publishes for a lifetime.

Scanners and digitizers let you add creative flair to your desktop projects; the Apple II Video Overlay Card (also called a *genlock*) lets you spice up home and classroom videos with computer graphics. While painting, drawing, and animation programs have sold well over the years, practical everyday applications aren't their strong suit. Overlaying graphics on video gives you another use for everything from Cartooners to PaintWorks Gold.

You see the results of genlock technology every time you watch the news or a sporting event. A meteorologist's map showing the movement of a storm—genlock; a CBS football telecast with John Madden's "chalkboard" analysis—genlock. You may not be able to produce the same effects you see in a professional broadcast, but if you have a strong video source and a good graphics program you can produce some impressive results.

Rumor has it that Apple Computer has had the Apple II Video Overlay Card ready for about two years and that it decided to announce it now only to quiet criticism about a lack of support for the II line. Whether or not it's by design, the timing seems right. Most homes and classrooms have VCRs; laser discs (a source of high-quality video) are making a comeback in schools; and with the number of painting, drawing, and animation programs available for the II, the software is already on store shelves. Videotape as a presentation medium is growing more popular; many businesses use it in place of the traditional printed promotional material.

Whether you want to produce graphically enhanced videos or customized graphics for desktop-publishing projects, everything's in place for you and your Apple II. You have the hardware to capture your image, the software to manipulate it, and the vehicle (either print or videotape) to deliver your message in a creative and attractive fashion. □

THREE WAYS TO MAKE YOUR APPLE SCREEN



THESE ARE TWO HUNGRY DINO-MIGHTS AND THEY'VE GOT BUBBLE FIGHT'N FUN DOWN TIGHT... You and your two brontosaurus buddies, Bub and Bob, are up to your brows in bubble trouble. You've got to battle battalions of bubbles by blowing and bursting billions of bubbles. It's a fast-paced bubble banquet through 100 screens of slap-happy suds. Got an appetite for fun...then get blowin'.



The #1 game in Europe for over 3 months. Scramble through 100 screens of laughs as your brontosaurus buddies, Bub and Bob, drive you crazy with non-stop action.

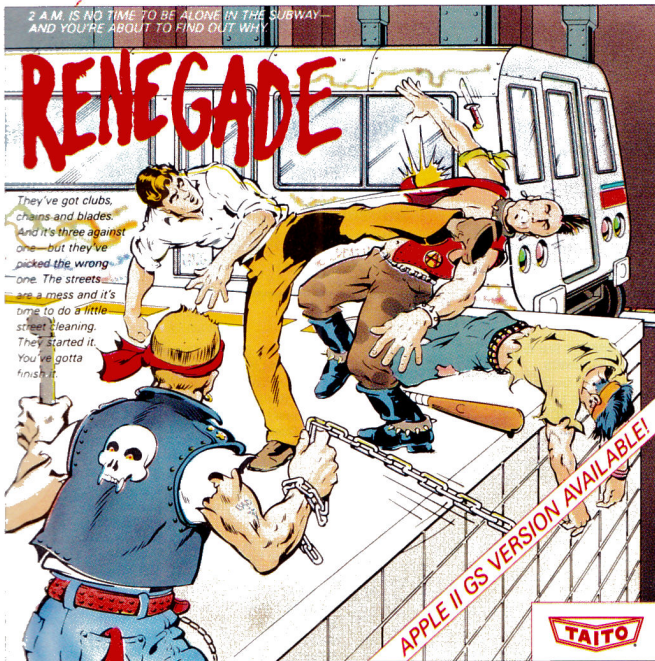

2 A.M. IS NO TIME TO BE ALONE IN THE SUBWAY—AND YOU'RE ABOUT TO FIND OUT WHY.

They've got clubs, chains and blades. And it's three against one—but they've picked the wrong one. The streets are a mess and it's time to do a little street cleaning. They started it. You've gotta finish it.

APPLE II GS VERSION AVAILABLE!
TAITO

This is the original arcade hit. Thrill to the arcade quality graphics of this fast-paced, street-style karate brawl. Find out what real action is all about!



SUDDENLY, SPACE IS A DEADLY PLACE...

There's no turning back. No place to run—no place to hide. They've destroyed your planet and now they're coming after you. Their destruction is your only chance for survival. It won't be easy, but survival never is.

APPLE II GS VERSION AVAILABLE!
TAITO

Don't settle for imitations. Add this arcade classic to your video collection. Arkanoid has been voted "one of the best home video games ever" by Electronic Game Player Magazine.

If you want to make your Apple explode with action you've got to give it dynamite games. These are the world famous original arcade screamers. Bubble Bobble™, Renegade™ and Arkanoid™ will make your Apple and Apple II GS computers do things you didn't think were possible.

Everyone knows that arcade games are the

benchmark for all other video games and Taito has been an arcade leader since 1953. Since then we've made over 1,000 classics for arcade and home play. Count on Taito to bring the heat of the arcade to your home computer.

Buy Taito products at leading stores everywhere. Visa/Mastercard holders can order direct anywhere in the U.S. by calling 1-800-663-8067.

Taito,® Renegade,™ Bubble Bobble,™ and Arkanoid™ are trademarks of Taito America Inc. Copyright © 1988. All rights

THE ONLY GAME IN TOWN!™



reserved. Apple and Apple II GS are trademarks of Apple Computer, Inc. Advertisement by: Qually & Company, Inc. (Chicago).

COMING SOON, THE CLASSIC MIND GAME, QIX.

Circle 110 on Reader Service Card.

GOLEM COMPUTERS

PRESENTS

Hot Disks!

TAITO



There's no turning back. No place to run—no place to hide. They've destroyed your planet and now they're coming after you.

Arkanoid
(IIGS & 512K) **\$22.00**

DISCOVERY SOFTWARE

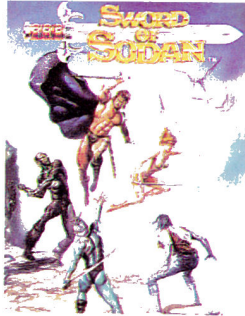

Your quest is vengeance—for the death of your father, the King, and the menace that is destroying your beloved land of the Northern Kingdoms. Travel in search of Zoras, the Necromancer, who has terrorized the people and plunged the kingdom into evil darkness.

Sword of Sodan
(IIGS & 768K) **\$32.00**

FTL

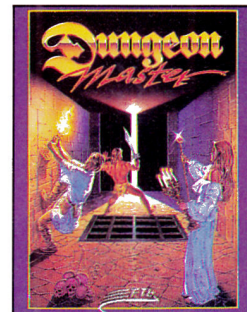

Dungeon Master puts you inside the most detailed dungeon ever created in software. All looks real. Choose your comrades for this adventure carefully.

Dungeon Master
(IIGS & 1MB) **\$27.00**

ENTERTAINMENT

| | | | | | | | |
|--|---------|---|---------|---------------------------------------|---------|---|---------|
| ACCOLADE Mini Putt (IIGS), Mean 18 (GS) | ea. 27. | Chessmaster 2100, Chuck Yeager AFT | ea. 26. | MASTERPLAY Star Saga I | 53. | Cavern Cobra, Strategic Conquest | ea. 32. |
| Jack Nicklaus Golf (IIGS) | 32. | Hunt For Red October (IIGS) | 35. | MASTERTRONICS | | SIERRA ON-LINE King's Quest I, II, III | ea. 31. |
| Test Drive II (GS) | 30. | Hunt for Red October (Ile/Ilc) | 27. | John Elway's Quarterback (Ile/Ilc) | 27. | Black Cauldron (IIGS) | 27. |
| Test Drive (Ile/Ilc), Bubble Ghost (IIGS) | 30. | John Madden Football (Ile/Ilc) | 33. | War in Middle Earth (IIGS) | 32. | Thexder (Ile/Ilc, IIGS) | ea. 24. |
| 4th & Inches (IIGS), Serve & Volley (IIGS) | ea. 27. | Tomahawk (IIGS) | 27. | MEDIAGENIC/ACTIVISION | | King Quest I, II, III, IV (IIGS) | ea. 32. |
| BRODERBUND Wings of Fury | 23. | Marble Madness (IIGS) | 17. | Last Ninja (IIGS) | 26. | Space Quest I, II (IIGS) | ea. 26. |
| Ultima I, III, Ancient Art of War at Sea | ea. 27. | Chessmaster 2100 (IIGS) | 33. | Maniac Mansion, Rampage | ea. 23. | Leisure Suit Larry II (IIGS) | ea. 26. |
| Ultima IV, V | ea. 40. | EPYX World Games, Winter Games | ea. 14. | Championship Basketball (IIGS) | ea. 26. | Gold Rush (GS) | 32. |
| BUENA VISTA Who Framed Roger Rabbit | 25. | World Games (IIGS), Winter Games (IIGS) | ea. 14. | MICROPROSE Pirates (Ile/Ilc, IIGS) | ea. 22. | Leisure Suit Larry II (IIGS) | ea. 32. |
| CINEMAWARE King of Chicago (IIGS) | 30. | Street Sports: Soccer (IIGS) | 14. | Silent Service, F-15 Strike Eagle | ea. 26. | Police Quest (IIGS), Manhunter NY (IIGS) | ea. 32. |
| Defender of the Crown (IIGS) | 32. | Sub Battle (Ile/Ilc, IIGS) | ea. 26. | Silent Service (IIGS) | 25. | SIR-TECH Wizardry, Wizardry 5 | ea. 32. |
| Lords of the Rising Sun (IIGS) | 32. | California Games, Destroyer (Ile/Ile/Ilc +) | ea. 26. | MINDSCAPE Balance of Power | 29. | Knight of Diamonds, Legacy of Lyllygamyn | ea. 32. |
| Rocket Ranger (IIGS) | 32. | California Games (IIGS) | ea. 26. | Cauntlet, Paper Boy, Paper Boy (IIGS) | ea. 25. | Return of Werda | 39. |
| DISCOVERY Sword of Sodan (IIGS 768K) | 32. | Sporting Baseball, Impossible Mission II | ea. 26. | Super Star Ice Hockey (IIGS) | 29. | SPECTRUM Tetris (Ile, IIGS) | 25. |
| ELECTRONIC ARTS Bard's Tale | 40. | Technoop (Ile/Ilc) | ea. 26. | Uninvited (IIGS), DejaVu I, II (IIGS) | ea. 32. | SSI Dungeon Master Asst. Vol. 1 | 20. |
| Cartooner (IIGS) | 30. | The Games-Summer/Winter | ea. 26. | PBI SOFTWARE All IIGS | ea. 32. | Advanced D & D-Pool of Radiance (Ile/Ilc) | 33. |
| Skate or Die (IIGS), Zany Golf (IIGS) | ea. 26. | Impossible Mission II (IIGS) | 27. | Sea Strike, Monte Carlo | ea. 26. | SUBLOGIC Fight Simulator II | 32. |
| World Tour Golf (IIGS) | 28. | F.T.L. Dungeon Master (IIGS) | 27. | Tower of Myrarglen, Alien Mind | ea. 33. | Scenario Disks 1 thru 6 | ea. 16. |
| Bard's Tale (IIGS), Bard's Tale II (IIGS) | ea. 32. | LOGICAL DESIGN WORKS | | | | TAITO Arkanoid (GS) | 22. |
| Bard's Tale II, III | ea. 32. | Vegas Gambler (IIGS), Vegas Craps (IIGS) | ea. 27. | | | Renegade (IIGS), Quix (IIGS) | ea. 22. |
| | | | | | | Bubble Bobble (IIGS) | 22. |



Beagle Brothers: Program Writer **\$ 33.**
 Beagle Brothers: Timeout-Telecom **\$ 45.**
 Beagle Brothers: Timeout-Report Writer **\$ 45.**
 Mediagenic: Neuromancer (IIGS) **\$ 30.**
 Designware: Revolution (IIGS) **\$ 32.**
 Mediagenic: Battlechess (IIGS) **\$ 32.**
 Epyx: Project Neptune **\$ 30.**
 Broderbund: Tangled Tales (Ile/Ilc) **\$ 20.**
 Electronic Arts: Halls of Montezuma (IIGS) **\$ 27.**
 Beagle Brothers: GS Font Editor **\$ 31.**

FOR FAST SERVICE 1-800-248-0363
 Mon. thru Fri. 7am - 6pm Sat. 9am - 4pm Pacific Time

FOR **FAST SERVICE** 1-800-248-0363

Mon. thru Fri. 7am - 6pm
Sat. 9am - 4pm Pacific Time

GOLEM COMPUTERS

P.O. BOX 6698
WESTLAKE VILLAGE, CA 91360



**Computer Eyes (IGS)
(Digital Vision)
\$195.00**

EDUCATION

| | |
|--|---------|
| BARRON'S Study Program For SAT V2.0 | 32. |
| BRITANICA Jigsaw (IGS) | 25. |
| Algebra 1, 2, 3, 4 | ea. 25. |
| Algebra 5 & 6 | 30. |
| Writing Skills 1-5 | 66. |
| BRODERBUND Science Tool Kit | 49. |
| Geometry (GS) | 53. |
| Science Tool Kit Module 1, 2, 3 | ea. 27. |
| Where in the USA is Carmen San Diego | 27. |
| Where in the World is Carmen San Diego | 24. |
| Where in the World (IGS) | 30. |
| Where in Europe is Carmen San Diego | 27. |
| DAVIDSON & ASSOCIATES | |
| Math Blaster Plus, Alge-Blaster | ea. 29. |
| Math Blaster Mystery | 29. |
| Math Blaster Plus (Talking) (IGS) | ea. 29. |
| Read & Roll, Word Attack Plus | ea. 29. |
| Math & Me, Reading & Me | ea. 24. |
| Math & Me (IGS), Reading & Me (IGS) | ea. 29. |
| Word Attack, Spell It, Grammar Gremlins | ea. 29. |
| DESIGNWARE Spellcopter, Math Maze | ea. 26. |
| Designasaurus (Ile/Ic) | ea. 25. |
| Designasaurus (IGS), Revolution 76 (IGS) | ea. 32. |
| Grammar Examiner, States & Traits | ea. 25. |
| The Body Transparent, European Nations | ea. 25. |
| ELECTRONIC ARTS | |
| Mavis Beacon Teaches Typing (IGS) | 32. |
| Mavis Beacon Teaches Typing (Ile/Ic) | 25. |
| FIRST BYTE (for IGS) (768K Req.) | |
| Mathtalk, First Shapes, Kidtalk | ea. 30. |
| Speller Bee, Smoothtalker | ea. 30. |
| Mathtalk Fractions, First Letter & Words | ea. 30. |
| HARDCOURT, BRACE, JOVANOVICH | |
| Computer Prep for the ACT | 29. |
| Computer Prep for the SAT | 26. |
| ILS SOFTWARE | |
| Computer Preparation SAT, GRE | ea. 33. |
| Computer Preparation LSAT, MBE | ea. 59. |
| MINDSCAPE Crossword Magic | 33. |
| SIMON & SCHUSTER Chem Lab | 23. |
| Typing Tutor IV (Ile/Ic/IGS) | ea. 29. |
| THE LEARNING COMPANY | |
| Reader Rabbit (IGS) | 36. |
| Writer Rabbit, Think Quick, | |
| Rocky's Boots (Ile/Ic/IGS) | ea. 30. |
| Math Rabbit, Reader Rabbit, Gertrudes | |
| Secrets, Magic Spells (Ile/Ic/IGS) | ea. 26. |
| Children's Writing | |
| Publishing Center (Ile/Ic, IGS) | 40. |
| UNICORN SOFTWARE (IGS Only) | |
| All About America, Read A Rama | ea. 40. |
| Math Wizard, Animal Kingdom | ea. 33. |
| Kinderama, Aesop's Fables | 33. |
| WEEKLY READER Sticky Bears - ABC's, | |
| Numbers, Shapes, Opposites, Reading, | |
| Basics, Typing, Drawing, Music, | |
| Spellgrabber, Town Builder | ea. 29. |
| Shapes (Talking, IGS) | 31. |
| Opposites (Talking, IGS) | 31. |
| ABC's Talking (IGS) | 31. |

BUSINESS

| | |
|---|------|
| BERKLEY SOFTWARES GeoPublish | 66. |
| GeoFile | 46. |
| BRODERBUND Bank Street Writer Plus | 47. |
| On Balance | 39. |
| CLARIS Appleworks GS | 205. |
| Appleworks (Ile/Ic) | 175. |
| DAC SOFTWARE DAC-Easy Accounting | 60. |

| | |
|--|---------|
| ELECTRONIC ARTS Deluxe Write II (IGS) | 53. |
| Deluxe Write II/Paint II Combo (IGS) | 89. |
| MANZANITA | |
| Business Works (ProDos, 2x3 1/2" Drives) | 287. |
| The Business Accountant (Dos, 2x5 1/4" Drives) | 230. |
| MILLIKEN Medley (IGS) | 119. |
| PEACHTREE Back to Basics Acct. Sys. | 129. |
| SENSIBLE SOFTWARE Sensible Writer | 62. |
| Sensible Speller IV (PRO DOS) | ea. 68. |
| Sensible Grammar Checker | 55. |
| SEVEN HILLS Graphic Writer III | 85. |
| SOFTWARE PUBLISHING | |
| PFS: Graph (128K PRO DOS) | 66. |
| PFS: File & Report (128K PRO DOS) | 66. |
| PFS: Workmates (128K PRO DOS) | 110. |
| PFS: Write w/Speller (128K PRO DOS) | 65. |
| SOFTWARE Softwood GS File | 61. |
| TIMEWORKS Publish it 2 | 84. |
| Graph It! | 47. |
| Font Pack I, II, Symbols & Slogans, | |
| People, Places & Things | ea. 27. |
| WORDPERFECT | |
| Wordperfect (IGS), (Ile/Ic) | ea. 93. |

HOME/PERSONAL

| | |
|--|---------|
| ACCOLADE Graphics Studio (IGS) | 46. |
| ABRACADATA Design Your Own Home | |
| Architecture (IGS) | 59. |
| Interior (Ile/Ic, IGS) | ea. 47. |
| Landscape (Ile/Ic, IGS) | ea. 47. |
| BAUVILLE 816/Paint (IGS) | 46. |
| Award Maker Plus | 24. |
| BRODERBUND The Print Shop | 29. |
| The Print Shop (IGS), Fantavision (IGS) | ea. 37. |
| The Print Shop Library (IGS)- | |
| Sampler, Party | ea. 23. |
| The Print Shop Library 1, 2, 3 | ea. 15. |
| Dazzle Draw | 40. |
| ELECTRONIC ARTS Deluxe Paint II (IGS) | ea. 22. |
| Arts Part I, II, Seasons & Holidays | 65. |
| Instant Synthesizer (IGS) | 56. |
| Music Construction Set (IGS) | 15. |
| Instant Music (IGS) | 15. |
| EPYX Print Magic | 40. |
| INTUIT Quicken | 39. |
| MECA Managing Your Money | 82. |
| MECC Calendar Crafter | 60. |
| MEDIAGENIC/ACTIVISION | |
| Writer's Choice Elite (IGS) | 59. |
| Paintworks Plus (IGS) | 56. |
| Paintworks Gold (1.25MB Req.) | 69. |
| Draw Plus (IGS), Music Studio (IGS) | 59. |
| Paint, Write, Draw Bundle (IGS) | 80. |
| MONOGRAM Dollars & Sense (128K/48K) | ea. 72. |
| OLTRAD Graphics Images (Ile/Ic) | 20. |
| Graphics Images (IGS) | 33. |
| PASSPORT DESIGN Master Tracks | 165. |
| Master Tracks Pro | 200. |
| Master Track Jr. (IGS) | 100. |
| Timeout-Filemaster, Sidespread, | |
| Power Pack, DeskTools II, Thesaurus | |
| Desktools | ea. 31. |

UTILITY/LANGUAGE

| | |
|---|----------|
| BEAGLE BROS. Timeout Graph | 52. |
| Timeout-Superfont, Quicksell, Telecom | ea. 45. |
| Timeout-Reportwriter | 48. |
| Timeout-Ultramacros, Spreadtools | ea. 35. |
| Timeout-Macrotools, Macrotools II | ea. 18. |
| Point to Point | 68. |
| GS Font Editor | 31. |
| BIG RED COMPUTER | |
| PS Lovers (IGS,Ile/Ic) | ea. 27. |
| Labels, Labels, Labels | 27. |
| BYTE WORKS ORCA/C, Pascal (IGS) | ea. 110. |
| ORCA/Desktop (IGS) | 45. |
| ORCA/M 1.1 | 56. |
| CENTRAL POINT Copy Two Plus | 23. |
| CHECKMATE TECHNOLOGY Proterm | 83. |
| MICOL Advanced BASIC (IGS) | 95. |
| ROGER WAGNER Merlin 816/PRO DOS) | 75. |
| Softswitch (IGS) | 40. |
| Graphix Exchange | 27. |
| Hyper Studio (IGS) | 84. |
| TERRAPIN Logo Plus | 90. |
| TML Pascal (IGS), Basic (IGS) | ea. 83. |
| Source Code Library (IGS) | 32. |
| Speech Toolkit (IGS) | 46. |
| VERSACAD CAD Apple Ilc/Ile | 66. |

COMPUTERS

| | |
|-----------------------|------|
| LASER COMPUTER | |
| Laser 128E | 375. |
| Laser 128EX | 445. |

MONITORS

| | |
|-----------------------|----------|
| LASER COMPUTER | |
| Color RGB Monitor | 325. |
| Amber, Green Monitor | ea. 105. |
| MAGNAVOX | |
| RGB/Composit (CM8762) | 285. |

HARD/FLOPPY DISK DRIVES

| | |
|--|----------|
| AMERICAN MICRO | |
| A.5 Drive (IGS, Daisychainable) 5 1/4" | 145. |
| CHINOOK SCSI Interface, Software | |
| CT-20 (Ile, IGS) | 630. |
| CT-40 (Ile, IGS) | 800. |
| CT-20c (Ile/Ic +) | 685. |
| CMS External w/SCSI Interface (Ile,IGS) | |
| 60MB (Stackable) | 910. |
| APPLIED ENGINEERING | |
| Vulcan Hard Drives | Call |
| 5 1/4 Drive (Ile/Ic, IGS) | 119. |
| Trans Drive Single | 294. |
| Trans Drive Dual | 195. |
| APPLIED INGENUITY | |
| InnerDrive 20MB (Ile, IGS) | ea. 455. |
| InnerDrive 40MB (Ile, IGS) | ea. 525. |
| LASER COMPUTER | |
| External Disk Drive (5 1/4" Laser) | 90. |
| External Disk Drive (5 1/4", Ile/Ic) | 95. |
| External Disk Drive (3 1/2" Laser) | 190. |
| Universal Disk Controller | 77. |

PRINTERS

| | |
|---|------|
| LASER COMPUTER | |
| 190A (Imagewriter I Compatible, serial) | 255. |
| 190E (Epson Compatible) | 225. |
| PANASONIC | |
| KX P1124 (80cps/24pin) | 340. |
| KX P1180 (192 cps/36 cps NLQ) | 210. |
| KX P1191 (240 cps/48 cps NLQ) | 275. |
| KX 10921 (240 cps/NLQ) | 340. |
| STAR MICRONICS NX-1000 | 210. |
| NX-1000 Rainbow (Color) | 265. |
| SEIKOSHA 1000AP (Imagewriter I) | 235. |

MEMORY & INTERFACE

| | |
|---|---------|
| APPLIED ENGINEERING | |
| Ram Factor 512K (I+ , Ile, IGS) | 330. |
| Ram Factor IMB (I+ , Ile, IGS) | 528. |
| Ram Works III 512K (Ile) | 286. |
| Ram Works III IMB (Ile) | 492. |
| GS-Ram 256K (IGS) | 162. |
| GS-Ram 1MB (IGS) | 470. |
| GS-Ram PLUS 1MB | 440. |
| GS-Ram PLUS 2MB | 750. |
| Z-Ram Ultra 2 512K + Clock (Ic) | 338. |
| Trans Warp (I+ , Ile) | 145. |
| Ram Express 256K (Ic +) | 184. |
| Ram Express 512K (Ic +) | 286. |
| Phasor (I+ , Ile) | 125. |
| Serial Pro (I+ , Ile, IGS) | 105. |
| Parallel Pro, Timemaster HO | ea. 73. |
| PC Transporter 768K | 498. |
| RamKeeper | 139. |
| Ramcharger | 132. |
| Sonic Blaster | 95. |
| Transwarp GS | 294. |
| DIGITAL VISION Computer Eyes (IGS) | 200. |
| MEMORY Ram's | Call |
| ORANGE MICRO Hotlink (Ic) | ea. 49. |
| Grappler C/MAC/GS, Programpler | ea. 74. |
| Imagebuffer | 89. |
| THIRDWARE Fingerprint GSI (IGS) | 65. |
| THUNDERWARE ThunderScan | 155. |
| ZIP TECHNOLOGY Zip Chip (Ile/Ic) | 166. |

MODEMS

| | |
|--|------|
| APPLIED ENGINEERING Datalink 1200 | 132. |
| Datalink 2400 | 178. |
| PROMETHEUS | |
| Promodem 2400A w/ Software | 145. |
| Promodem 2400C (external) | 165. |
| SUPRA 2400 External | 135. |

ACCESSORIES

| | |
|---|----------|
| BLANK MEDIA (Bulk) | Call |
| CH PRODUCTS Flight Stick | 50. |
| Mach III w/fire Button (Ile/Ic, IGS) | ea. 34. |
| Mach IV Plus (IGS/Ic) | 59. |
| EPYX 500Jx Joystick (I+ , Ile/Ic, IGS) | 28. |
| KENSINGTON System Saver | 64. |
| Turbo Mouse ADB (IGS) | 115. |
| System Saver IGS | 73. |
| KURTA Apple IS/IGS Tablet (IGS) | 320. |
| LASER COMPUTER Mouse | 51. |
| Expansion Box | 55. |
| Cables - Parallel, Serial, RGB, Modem | ea. 16. |
| MOUSE SYSTEMS A + Mouse | 75. |
| A + Mouse ADB (IGS) | 85. |
| RIBBONS Imagewriter II, 4 Colors | ea. 750. |
| Imagewriter (Black, Red, Brown, etc.) | 75. |

FOR CUSTOMER SERVICE CALL 1-805-499-7785 Monday thru Friday 9 a.m. to 5 p.m. - Pacific Time

To order call toll free or send check or money order to the P.O. Box only. VISA/MC orders welcome. Sorry, no C.O.D. Personal and company checks, allow 10 working days to clear. Specify computer type, if to back order or to send refund. California residents add 6% sales tax. Include phone number with order. All sales are final. Defective items will be replaced or money refunded, at our discretion. Call for Return Authorization number. We are not responsible for suitability or compatibility. Restocking fee of 15% will apply. Shipping and handling: All shipments U.P.S. if possible. Continental U.S.- Software: add \$5.00; min.. Hardware: add 5% (\$6.00 min). APO, FPO Alaska, Hawaii, Puerto Rico and Canada. Software: add \$8.00 min. Hardware: add 10% (\$10.00 min).

ALL ITEMS SUBJECT TO AVAILABILITY. PRICES AND STIPULATIONS SUBJECT TO CHANGE WITHOUT NOTICE.

1111 Rancho Conejo Blvd. #407

IN CALIFORNIA CALL 1-805-499-0197

Newbury Park, CA 91320

Mon. thru Fri. 7am - 6pm - Sat. 9am - 4pm Pacific Time

ORDERS ONLY 1-800-248-0363 • FAX (805) 498-7689





SPECIAL EFFECTS

THANKS FOR THE ARTICLE ON Apple IIs in special education ("Partners in Special Achievement," April 1989, p. 54). This combination enables children and adults to participate actively in their world, thus improving their quality of life.

On page 60, you mentioned our company, but failed to provide an address. Technology for Language and Learning is a newly formed nonprofit organization dedicated to advancing the use of technology and computers with children and adults with special needs. One of TLL's projects has been to create and collect high-quality public-domain software. We then distribute these programs to parents, educators, and organizations involved with children or adults with language impairments, or learning or physical disabilities.

Programs are \$5 each, plus postage and handling. If you'd like to receive a complete catalogue, please write to TLL.

Joan Tanenhaus, M.A., CCC
Speech/Language Pathologist,
Computer Consultant
Executive Director
Technology for Language and Learning
P.O. Box 327
East Rockaway, NY 11518-0327

TAX CREDIT

CYNTHIA FIELD'S REVIEW OF tax software ("Tax Time: It's Closing In," March 1989, p. 50) overlooked TaxCalc-88, a menu-driven tax-preparation program for the entire Apple II family. This two-year-old program requires 48K and one drive, and comes with tax-theory and IRS worksheets built in. TaxCalc-88 also includes a pop-up calculator. It doesn't print any of the forms, though; you'll need to fill those in by

hand. (We'll send requested IRS forms.)

The program supports Forms 1040, A-E, and SE, and Schedules 2106, 2119, 2441, 3903, and 4562. The tax guide includes advice and tips, flowcharts, and common questions and answers. Telephone support is also available. TaxCalc-88 costs \$29.95 plus \$2 shipping. Annual updates are \$19.95.

Andrew R. Kramer
Perfect Solutions Software
3701 Savoy Lane
West Palm Beach, FL 33417

SOFT PRAISE

I RECENTLY PURCHASED SOFTWARE GS File for my IIGS. When I tried booting the program, it got stuck. Foolishly, I'd purchased the program in a Navy Exchange; returning it would have involved a 125-mile round trip.

That same evening I saw an ad for GS File that listed the company's 800 telephone number. I called and explained my problem to a very pleasant individual. She advised me to return the package, and Brown Wagh would send me a new 768K version free because I'd purchased the program within the last 30 days.

One week later I received the updated version of GS File. This is the first good experience I've had dealing with a software company. We software users should support publishers with this type of policy.

Russell F. McCann
10 Bassett Street
Foxboro, MA 02035

LOWDOWN ON LOGO

I'VE TAUGHT IN AN ELEMENTARY-school computer lab for the last two years and use LogoWriter almost exclu-

sively. It's both powerful and easy to operate. I instruct 650 first- through fifth-graders per week, and they take to the program immediately. They actually become programmers in the Logo language.

I enjoyed Carol Holzberg's review of LogoWriter ("Learning with LogoWriter," April 1989, p. 28), but would like to comment on two small inaccuracies. She states, "LogoWriter starts you off on the procedure slide of a page when you select New Page or load a scrapbook file." LogoWriter actually starts you off on the Turtle side when you make these selections.

Second, to repeat a command you don't need to "direct the cursor to the first letter of the command," and then "press the right-arrow key until the cursor rests at the end of the line." Instead, just place the cursor on the command line (beginning, middle, or end) and press Return.

LogoWriter's simplicity lets even my youngest students experience success in programming. I believe this product is the "showcase" piece of software for our elementary-school computer labs.

Robert Scheinblum
Cutler Ridge Elementary
20210 Coral Sea Road
Miami, FL 33189

PACKED FULL

I WAS SURPRISED AT THE ERRORS, omissions, and overall "flawed but adequate" rating that appeared in your review of Despkak ("In with the New," March 1989, p. 30).

To begin with, the Installation section of the Despkak manual offers clear documentation, as do the Apple manuals that come with the IIGS. While your reviewer referred to the "installation hurdle," this procedure is quite ►



EasyLink™ Does It.

Using the right communications software is the key to getting the most from your modem. The ideal software would be intuitive enough to speed you through the hassle of logging on, flexible enough to work with mouse or keyboard, sophisticated enough to reach virtually any bulletin board or service and simple enough to be useful right away ... even for beginners. EasyLink™ does it. And more.

For starters, yes, EasyLink will work with your IIGs, enhanced Ile (128K), IIC or IIC Plus—it's fully Hayes compatible and features 132-column VT100 emulation. EasyLink supports XModem, XModem/CRC, X-Modem/ProDOS and YModem with automatic protocol selection on both sending and receiving. The Mac-like desktop interface can be operated from either mouse or keyboard and automatically configures the hardware setup.

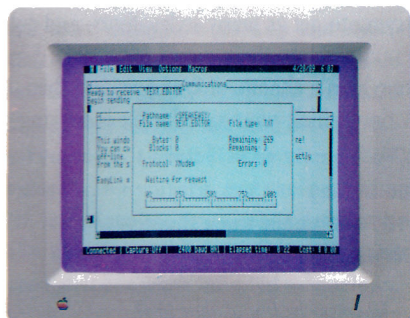

Open two windows at once.

For the first time, two mobile, resizable

windows can be open at the same time. You can actually work with the built-in text editor window *while* the on-line window continually updates incoming messages and information. Access your own files (or create new ones), edit the text with pull-down menu commands like cut, copy, paste, find and replace; then send the text in perfect, edited form. Even print text directly from the window—all without breaking contact with the on-line window.

Software that learns by watching.

Our engineers have developed a rich macro language that allows you to easily learn to write your own macros. EasyLink can autodial a number for you, log on, redial or disconnect if the number's busy—and do it all automatically. In fact, the software actually "watches" you log on the first time and "learns" how to do it *for you* the next time.

The macros can be pre-compiled for added speed and up to 18 macros can be executed with a single keystroke. An unlimited number of macros can be executed via a proper command and the language includes such esoteric features as integer variables, complex expressions, conditional execution and subroutines. All keyboard commands can be re-assigned to any key.

Conference mode.

Tired of watching your messages broken up by incoming transmissions? EasyLink's

built-in conference mode lets you enter a sentence or message in one piece and then send it all at once.

Track costs as you go.

EasyLink also comes with an automatic rate calculator that watches those phone bills for you, by continually metering online costs.

Compare AE's EasyLink with any other communications software. For completeness of features, ultimate flexibility and ease of use. For beginners and bulletin board junkies alike, EasyLink does it.

Order today!

To order or for more information, see your dealer or call (214) 241-6060 today, 9 am to 11 pm, 7 days. Or send check or money order to Applied Engineering. MasterCard, VISA and C.O.D. welcome. Texas residents add 7% sales tax. Add \$10 outside U.S.A.

EasyLink Software \$99

AE APPLIED ENGINEERING®

The Apple enhancement experts.

A Division of AE Research Corporation.

(214) 241-6060

P.O. Box 5100, Carrollton, TX 75011

Prices subject to change without notice. Brand and product names are registered trademarks of the respective holders.

painless: Copy the desired accessory to a folder on the program disk, and reboot.

Ms. Payne states that with the Appointment Calendar "the check mark isn't removed after clearing out an appointment." We haven't been able to re-create this situation and assume she simply "spaced" over the entry. She also refers to compatibility problems with MultiScribe GS and WordPerfect. We find the accessories work fine with these programs.

Contrary to the review, furthermore, Add DA is not a tool for copying accessories from one disk to another, nor do you need two disk

drives. Also, the C key on the Despkak Calculator is the clear—it doesn't close the calculator.

The reviewer states that the program requires 512K, and she suggests using 756K. The memory requirement for each accessory ranges from 3K-30K, and it's unlikely you'll want to use every one; install those that best suit your tastes and needs.

The review also failed to mention several features. For example, Super Scrap includes its own painting program with drawing and selecting tools, 16 colors in 320 and 640 mode,

and the ability to create, name, rename, sort, and find scraps. The Mini Database, furthermore, lets you print mailing-list labels.

Finally, readers should note our support program: Registered Despkak owners can write or call (24 hours a day, seven days a week) with any question about the IIGS, get fixes immediately via modem, and receive new versions free or at cost.

Kevin E. Seidule, President
Simple Software Systems International
4612 North Landing Drive
Marietta, GA 30066

The Sensational Lasers

Apple IIe/IIc Compatible

ONLY **\$395** Includes 10 free software packages!

New! Now Includes **COPY II PLUS®**



The Laser 128® features full Apple® II compatibility with an internal disk drive, serial, parallel, modem, and mouse ports. When you're ready to expand your system, there's an external drive port and expansion slot. The Laser 128 even includes 10 free software packages! Take advantage of this exceptional value today..... **\$395**

Super High Speed Option!

ONLY **\$459**

The **LASER 128EX™** has all the features of the Laser 128, plus a high performance triple speed processor, and memory expansion to 1MB. Get the Apple compatible that's three times faster than the IIe or IIc!..... **\$459**

DISK DRIVES

- 5 1/4" Laser External Disk Drive..... **\$109**
- 5 1/4" Apple IIe Compatible Disk Drive..... **\$109**
- 5 1/4" Apple IIc Compatible Disk Drive..... **\$109**
- 3 1/2" Apple Compatible Disk Drive..... **\$179**

ACCESSORIES

- 12" Monochrome Monitor..... **\$89**
- 14" RGB Color Monitor..... **\$249**
- Laser 190 Printer..... **\$249**
- 2400 Baud Modem..... **\$149**

Save Money by Buying a Complete Package!

THE STAR: A Laser 128 Computer with 12" Monochrome Monitor and the Laser 190 Printer..... **\$695.00**

THE SUPERSTAR: A Laser 128 with 14" RGB Color Monitor and the Laser 190 Printer..... **\$883.00**

U.S.A. MICRO

YOUR DIRECT SOURCE FOR APPLE AND IBM COMPATIBLE COMPUTERS

2888 Bluff Street, Suite 257 • Boulder, CO. 80301
Add 3% Shipping • Colorado Residents Add 3% Tax

Phone Orders: 1-800-654-5426

8-5 Mountain Time • No Surcharge on Visa or MasterCard Orders!
Customer Service: 1-800-537-8596 • In Colorado: (303) 938-9089

Your satisfaction is our guarantee!

Laser 128 is a registered trademark of Video Technology Computers, Inc. Copy II Plus is a registered trademark of Central Point Software. Apple, Apple IIe, Apple IIc, and Integer are registered trademarks of Apple Computer, Inc.

CLARIS CUSTOMERS

I'D HEARD THAT SINCE CLARIS bought out StyleWare it was providing technical support for all of StyleWare's former products. I've written to Claris twice now—once regarding TopDraw and another time concerning MultiScribe. I've yet to hear from the company. What's going on?

Robert P. McCormick
79 Rye Street
Broad Brook, CT 06016

According to a recent press release, only Claris customers will be eligible for its customer-relations and technical-support services. To become registered Claris customers, owners of Apple-label products must participate in Claris' upgrade program. For more information, check "Claris Clears the Air," What's New, May 1989, p. 14.

—eds.

ARTISTIC LICENSE

ENJOY READING *INCIDER'S* WHAT'S New section each month, but I think the truly new item has to be some desktop-publishing system.

The *inCider* staff must still be in the experimental stages with its new toy. The March and April layouts look as though someone's trying to get as many styles, fonts, and colors crammed into those pages as possible. Everyone likes a change of font now and then, but I don't think your new layout is making the grade.

Ed Danley
1879 Slippery Rock Road
Naperville, IL 60565-6766

Do we make fun of your toys?

—eds.

BAD BOOT

HAS ANYONE HAD TO WARM up his or her IIGs before it'll boot properly? Mine displays an unintelligible screen and halts when I first turn it on. If I leave it that way for a few minutes, then turn it off and on again, the GS boots fine. This began when I had new ROM and VGS chips installed.

Jere T. Murray
P.O. Box 2857
Homer, AK 99603-2857

There might be a bad contact. Return the unit to your dealer to reseat the chips. —eds.

CORRECTIONS

In our May 1989 **AppleWorks in Action**, **Formula 11** (p. 72) contains an inaccuracy. It should read:

@IF(A17<=(C8*12),D16-C17,0)

In addition, **Figure 2** (p. 70) should contain a "1" in **A16**.

In "Templates from Heaven" (May 1989) the phone number for the **National AppleWorks Users Group** is listed incorrectly in the **Product Information box** (p. 48). The correct number is **(313) 454-1115**.

CLARIFICATION

Writing Status Report in **May 1989** ("Lip Service," p. 20), I mistakenly assumed that **Clayton Walnum**, executive editor of **ST-Log** and **ANALOG Computing**, was speaking for those magazines when he said in **The Writer** that free-lance reviewers would have better luck selling positive reviews, and that therefore **ST-Log** and **ANALOG Computing** publish only positive reviews. In fact, **ST-Log** and **ANALOG Computing** publish fair and often critical reviews. I apologize to those magazines, their editors, and their readers for my mistake. Good magazines publish both good and bad reviews, and good writers work for good magazines.

—Paul Statt

PRO WIMP

YOUR MARCH EDITORIAL (*INCIDER's* view, "EAST-COAST WIMPS," p. 8) touched on the Mac/Apple II argument. I like Macintosh features—pull-down menus and point-and-click—but I bought the Apple II with its abundance of educational software to benefit my kids. I like AppleWorks, but I don't feel I need to use it exclusively. I'm for blending the two computers and making as much Mac-like software avail-

able for the Apple II as possible. If you want to stay with AppleWorks, that's fine, but I'd hate to see alternatives discouraged.

Steve Cannon
P.O. Box 146
Bluff, UT 84512

INCIDER WELCOMES READERS' COMMENTS. WE RESERVE THE RIGHT TO EDIT LETTERS FOR CLARITY, STYLE, AND SPACE. PLEASE ADDRESS YOUR CORRESPONDENCE TO LETTERS, *INCIDER*, ELM STREET, PETERBOROUGH, NH 03458.

LOWEST PRICE DIRECT FROM MANUFACTURER

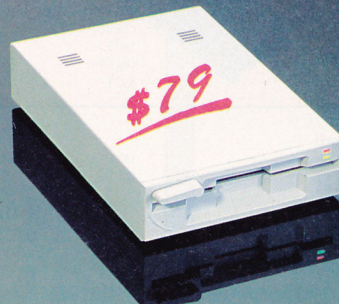

5¼" APPLE® II DISK DRIVE

- Apple® II Series & Laser 128 series compatible
- Speed adjustable
- Brushless direct drive motor
- 48 hrs factory burnt-in

Apple IIc/IIgs cable installed — \$7.00 extra
 Unidisk Port option — \$23.00 extra

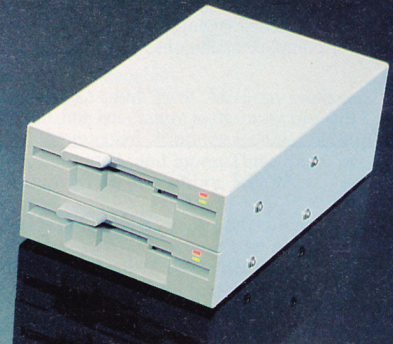

5¼" DRIVE FOR PC TRANSPORTER®

You can use our drive with PC Transporter to run MS-DOS programs on your Apple II like they do on IBM compatibles.
 Single-drive system \$169
 Dual-drive system \$259
 Half-height drive \$115
 (Add to single-drive to make dual-drive system.)

NOW AVAILABLE—HARD DISKS FOR ALL APPLE II'S (YES, EVEN THE IIC)

| | |
|--|-------|
| 20 MB SCSI Hard Drive for IIe/IIgs | \$619 |
| 30 MB SCSI Hard Drive for IIe/IIgs | \$719 |
| 20 MB SmartPort Hard Drive for IIc | \$719 |

ALSO AVAILABLE:
 EXTERNAL 3.5" 800 K Drive for Apple IIgs



6-MONTHS WARRANTY

SEND MONEY ORDER OR CHECK TO:
KINSON PRODUCTS CORP.

182-484 Sunrise Highway,
 Rockville Centre, NY 11570.
 For inquiry please call (516) 763-0906
 Fax (516) 763-0938



No COD Order
 Accept School's P/O

TOLL FREE PHONE NO.
 FOR ORDER ONLY
 1-800-433-6224 (OUTSIDE NY)
 1-800-553-6224 (INSIDE NY)
 Please call between Eastern time
 8:00 A.M. — 6:00 P.M.

Shipping: UPS ground: \$6.00 per drive
 except \$10.00 per drive for dual-drive.
 Fed-Express (next day air): \$9.00 per drive
 except \$18.00 per drive for dual-drive.
 NY Resident: Please add 8% sales tax.

Circle 131 on Reader Service Card.

Apple is a trademark of Apple Computer. PC Transporter is the trademark of Applied Engineering. IBM is the trademark of IBM Corp.
 Terms: 15% restocking fee on non-defective goods. No return w/o RMA#. No refund on shipping.

Look Here First!



DB MASTER

Those who use it know it's the best. DB Master Professional is the most powerful, yet easy to use data base manager for the Apple II. With DB Master Professional not only can you sort, select and tally, you can cross reference, calculate, create formatted reports, generate form letters, update other categories and files, and more. DB Master Professional speaks your language — simple commands for complex operations. **\$239.00**

ZIP CHIP

Move your computer into the fast lane with an accelerator chip from Zip Technology. Choose your need for speed—4 or 8 mhz. Easy to install, addresses all memory, compatible with all software and hardware. Need an upgrade? We'll give you \$50 for your current accelerator with the purchase of an 8 mhz. Zip Chip. **4 mhz. - \$139.00. 8 mhz. - \$179.00.** Coming this Fall! 8 mhz. Zip Chip for the IIgs - **\$249.00.**

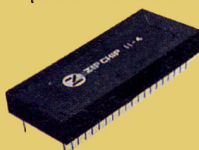

PROTERM

We've tried them all and none compare. Proterm combines almost every imaginable feature while keeping the program fast and easy to use. Whether you're a programmer, professional, or just starting out, there isn't a better communications program for you than Proterm. Features include: scroll back buffer, 1 key macros, VT emulation, password protection, remote down loads, 2 modem transfer protocol, and more. **\$93.00.**



HARD-DISKS

It's no secret. SCSI is the key. Apple's big plan for the Apple II is based on SCSI technology.



CHINOOK: Full SCSI compatibility, quiet operation, small in size, Apple SCSI interface card, 1

year warranty. Chinook has proven to be one of the most reliable units available. Works with Apple IIe, IIc, IIgs, and Mac compatible computers. EasyDrive recommended but not included. **CT20 \$639.00, CT40 - \$800, CT 20C - \$675.00.**



CMS: Fully SCSI compatible, the CMS series comes with their own interface for the Apple II or you can use Apple's interface, a good bet! Mac compatible. With CMS you can have an Apple II and a Mac share the same unit, simultaneously! 1 year warranty available. Comes in a variety of sizes. EasyDrive recommended but not included. **20 meg. - \$629.00, 30 meg. - \$719.00, 40 meg. - \$769.00, 60 meg. - \$839.00, 80 meg. + - Call.**

SIDER: D2 - \$499.00, D4 - \$645.00, D4T - \$855, D9 - \$1,465.00, C96 - \$2,155.00.

EASYDRIVE: Designed to make hard-disks user-friendly for the beginner and professional. Set up custom menus, and launch programs at the touch of a key. Status graphs display disk space and optimization information. Includes a ProDOS beginners book that illustrates ProDOS and examples of hard-disk set-ups. **\$69.95.**

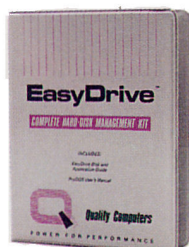

MAGNA CHARTA

You won't find a better graphing utility! Create impressive, multi-colored, 3-D images. Put your data in perspective with 9 different styles of charts, then bring them to life with full, crystal-clear color. Your data will become a work of art! Magna Charta is easy to use, fast, and you'll love the detailed output. **\$47.00.**



MP6

The best 5 1/4 drive available. We tried dozens of 5 1/4 drives, but not one came close to offering as much as this one. Not even at twice the price. The MP6 offers 320K capacity treating both sides of the disk as one device. Or, you can use the toggle switch to electronically flip a 2 sided disk. Crystal controlled disk speed means NO DISK SPEED FLUCTUATION, the leading cause of lost data. Packed with features, the MP6 offers: noiseless operation, disk eject, daisy chain port and more. The MP6 is made in the USA, and comes with a 2-year warranty — parts and labor. You can look but you won't find a better drive for any price. **\$179.00.**

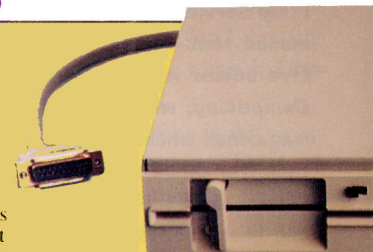

QC Clipboard

TimeOut Series: Thesaurus, Desktools

I&II, Sidespread, PowerPack, Spread

| | |
|------------------------|--------|
| Tools I&II | 31.00 |
| Graph | 52.00 |
| Quickspell, Superfonts | 44.00 |
| Ultramacros | 37.00 |
| Macro Tools I & II | 19.00 |
| Diversitune | 55.00 |
| Diversicopy | 30.00 |
| Managing Your Money | 99.00 |
| Quicken | 34.00 |
| Printshop | 29.00 |
| Printshop GS | 36.00 |
| Copy II + | 23.00 |
| WordPerfect GS | 99.00 |
| Sensible Grammar | 55.95 |
| Publish It 2.0 | 84.00 |
| AppleWorks 2.1 | 199.00 |
| AppleWorks GS | 219.00 |
| Computer Eyes Iic | 99.00 |
| Computer Eyes Iie | 99.00 |
| Computer Eyes IIgs | 204.00 |
| Word Bench | 94.95 |
| Orca M | 46.00 |
| Orca Pascal | 74.00 |
| Orca Pascal Debugger | 80.00 |
| Orca Desktop | 39.00 |
| TML Basic | 89.00 |

GAMES:

| | |
|-------------------|-------|
| Police Plotter | Call |
| Sword of Sodan | Call |
| King Quest I-IV | 32.00 |
| Mean 18 | 24.95 |
| California Games | 24.95 |
| California Dreams | 24.95 |
| Alien Mind | 34.95 |
| Hardball GS | 29.00 |
| PaintWorks Gold | 62.95 |
| PaintWorks + | 49.95 |
| 4th and Inches | 32.95 |

MISCELLANEOUS:

| | |
|-----------------------------|-------|
| Pack of 10 5.25 Diskettes | 6.95 |
| Pack of 10 3.5 Diskettes | 9.95 |
| 5.25 Disk Storage Case (50) | 12.00 |
| 3.5 Disk Storage Case (30) | 12.00 |

CABLES:

All makes - most 14.95

HARDWARE:

| | |
|------------------------------|--------|
| Kensington System Saver Iie | 59.00 |
| Kensington System Saver IIgs | 69.00 |
| Turbo Mouse ADB | 124.00 |
| Thunderscan | 175.00 |
| Laser 128 EX | 449.00 |
| Laser Mouse | 79.00 |
| AI Ext. 80 Column | 59.00 |
| AI TimeCard | 69.00 |
| SMT No Slot Clock | 44.00 |
| Print Tech II | 49.00 |
| Finger Print GSI | Call |
| Image Buffer 64K | 79.00 |
| Mach II, III, IV | Call |
| Flight Stick | Call |

MONITORS:

| | |
|------------------------|--------|
| Magnavox RGB Color 14" | 279.00 |
| Amber, Green | 99.00 |

MEMORY UPGRADES:

| | |
|-------------|--------|
| 256K 150ns | 79.00 |
| 256K 120ns | 89.00 |
| 1024K 120ns | 189.00 |
| 1024K 100ns | 199.00 |

OTHER PRODUCTS AVAILABLE CALL!

QUALITY'S VERY OWN



EASYDRIVE: The complete hard-disk management system for the Apple II. ProDOS 8, 16, GS/OS compatible, and menu-driven.

Features include: quick launch, backup/restore, optimizer, and indexing. The treesurgeon utility puts you in control by displaying a map of the directories, the files, and the commands. You see your hard-disk in terms you can understand **\$69.95.**

RAMUP: Load AppleWorks, Timeout Series Dictionaries, Proterm and all of your favorites onto your ramcard at once.



RAMUP makes using a ramdisk a snap. Menu-driven RAMUP lets you reboot your system to work with unloadable applications like CPM, PASCAL, copy protected games, and then later return to the programs still intact on the ramcard. Features include: backup / restore, auto load, and more. Three years as the top-selling ram disk utility. **\$39.95.**

REPAIRWORKS: In a perfect world a program like RepairWorks wouldn't be necessary. Unfortunately the world isn't perfect and for those who have peered tearfully into a monitor filled with the dying gasps of our precious work, it can almost seem cruel. But, don't despair! RepairWorks can soften the blow of cruel fate when it involves your AppleWorks files. RepairWorks will examine your files and surgically remove the offending problems, reducing or eliminating the need to recreate your work. Available on 3.5 and 5 1/4 disks. **\$39.95.**



AE APPLIED ENGINEERING

RAMWORKS III

| | |
|--------|-----|
| 256K | 179 |
| 512K | 269 |
| 1 meg. | 449 |

ULTRA II

| | |
|--------|-----|
| 256K | 239 |
| 512K | 329 |
| 1 meg. | 499 |

RAMFACTOR

| | |
|--------|-----|
| 256K | 209 |
| 512K | 319 |
| 1 meg. | 499 |

GS RAM

| | |
|----------|-----|
| 256K | 179 |
| 512K | 269 |
| 1 meg. | 449 |
| 1.5 meg. | 619 |

GS RAM+

| | |
|--------|-----|
| 1 meg. | 349 |
| 2 meg. | 549 |
| 3 meg. | 749 |

RAMWORKS EXP.

| | |
|--------|-----|
| 1 meg. | 349 |
| 2 meg. | 549 |

RAMFACTOR EXP.

| | |
|--------|-----|
| 1 meg. | 379 |
| 2 meg. | 579 |
| 3 meg. | 779 |

| | |
|---------------------|-----|
| RAMCHARGER | 133 |
| RAMKEEPER | 139 |
| SLOT MAKER | 34 |
| DATALINK 2400 | 179 |
| PC TRANSPORTER | 509 |
| Iie KIT | 29 |
| Iigs KIT | 39 |
| TRANSDRIVE (Single) | 199 |
| TRANSDRIVE (Duo) | 299 |
| SERIAL PRO | 109 |
| SONIC BLASTER | 98 |
| TRANSWARP (Iie) | 149 |
| TRANSWARP (gs) | 299 |
| PARALLEL PRO | 79 |
| AE 5 1/4 | 119 |
| POWER SUPPLY | 59 |
| RAMCHARGER | 133 |
| TIMEMASTER H.O. | 78 |
| EXTENDED 80 COL. | 99 |
| Z80 | 119 |
| PHASOR | 139 |
| VIEWMASTER | 124 |
| COLORLINK | 99 |

WE'LL MATCH ANY PRICE!

POLICY:

Visa and MasterCard - no added surcharge.
C.O.D. certified - add \$2.95
If order is split, we pick up freight charges on balance of items.
Shipping UPS, Airborne, Federal Express and U.S. Mail.
Saturday deliveries available.

RETURNS: Defective software will be replaced immediately with the same item. Defective hardware will be replaced or repaired at our own discretion. Call customer service at 313-331-1120 to obtain a return authorization number before returning goods. Product purchase in error subject to 15% restocking fee.

SCHOOLS: Schools are half of our business. We accept school P.O.'s by mail or by fax. Call us. We'll work for you.

DEALERS: Call

USER GROUPS: Volume discounts on group purchases. Call us for details.



Quality Computers

POWER FOR PERFORMANCE

15102 Charlevoix • Grosse Pointe, MI 48230 • 313/331-0700
Orders & P.O.s by FAX: 313/331-0663

1-800-443-6697

WHAT'S NEW

By the inCider staff



ACROSS THE ATLANTIC

Aline, a French on-line service, now offers chess players in the New World a competition with players in the Old. The trans-Atlantic game is based on EE, a chess game and information service sponsored in part by the Continent's leading chess magazine, *Europe Echess*.

You'll find the American translation on the Aline on-line service. Aline charges no registration or subscription fee in the States; telecommunicators pay 30 cents per minute in the New York metropolitan area, 20 cents per minute outside the city. Dial (212) 540-LINK to sign on, or write to Newcom Link, 450 Park Avenue, New York, NY 10022. —P.S.

BEAGLE BUYS POINT-TO-POINT

Beagle Bros Software has acquired the rights to publish the popular telecommunications program Point-to-Point from its author, Gary Little.

Point-to-Point had been published by Pinpoint Software (Emeryville, CA), which decided earlier this year to no longer support its Apple II line of software and to concentrate on MS-DOS desktop-publishing software.

Beagle Bros has contracted with Little to "substantially revise and expand" the program. Point-to-Point is the telecommunications program that works most like AppleWorks, the best-selling integrated package for the Apple II published by Claris Corporation (Santa Clara, CA).

Beagle Bros is noted for software that enhances AppleWorks, such as its programs UltraMacros and QuickSpell; Point-to-Point is a natural extension of the company's AppleWorks-accessory line. Beagle Bros' TimeOut Communicate, a telecommunications program that works within

AppleWorks, has been in planning for almost a year now; its fate is uncertain.

Beagle Bros announced also that it would allow owners of Pinpoint's KeyPlayer, Spelling Checker, Document Checker, Graphic Edge, and Desktop Accessories (which Beagle Bros didn't buy) to upgrade to analogous Beagle Bros products for prices ranging from \$25 to \$45. Owners of any other spelling checker can purchase TimeOut QuickSpell for \$35. By upgrading, owners ensure continued product support.

Owners of older versions of Point-to-Point can upgrade to the expanded Beagle Bros version for \$30; the program will cost \$99.95. (Prices quoted here don't include \$3.50 for shipping and handling; Beagle Bros products are also available at Apple software dealers.)

Call or write Beagle Bros at 6215 Ferris Square, Suite 100, San Diego, CA 92121, (619) 452-5500, or circle number 360 on the Reader Service card for more information.

—P.S.

MAY WE ASK A FEW QUESTIONS?

The Apple Pi user group in Thousand Oaks, California, is asking some 1100 Apple II clubs across the country to survey their members. Apple Pi hopes to learn how much the Apple II community cares about the machine, and has graciously offered to share the information with John Sculley at the Apple shareholders meeting in January 1990.

If your organization has already received the survey, fill it out and send it back. If your group hasn't heard from the folks at Apple Pi, write them at 2899 Agoura Road, #278, Westlake Village, CA 91361, and ask for a copy. —P.S.

APPLEFEST GIVES A LITTLE BACK

Every ticket for AppleFest Boston in May put another dollar's worth of Apple computers into Massachusetts schools, as Apple Computer and Cambridge Marketing, the show's sponsor, devised an innovative fund raiser.

At press time, Cambridge Marketing expected to sell 20,000 tickets at the three-day event, which meant \$20,000 for the Massachusetts Department of Education.

Apple created the educational market for personal computers with its original grants of computers to schools; Keith Fox, Apple's manager for eastern Massachusetts, explains, "With education funds in the state under pressure, we felt that AppleFest was an excellent vehicle for this kind of direct aid." —P.S.

"The customer has always been confused, but now the industry is catching up."

—Mort Rosenthal, CEO of Corporate Software, on the microcomputer industry in 1989.

QUOTES



"We will not be putting the resources toward the Apple II that we will for the Mac."

—Stu Roberson, Mediagenic

“GET ME A2-CENTRAL”

“Where did I read that?”

If you subscribe to Tom Weishaar's monthly newsletter *A2-Central* (formerly *Open-Apple*) and ask yourself that often, you'll appreciate having the full text of *Open-Apple*, from January 1985 through the current month, in text files on disk for only \$39.95.

These 3½-inch disks contain the full text of every issue. The advantages for those with impaired vision are obvious—you can listen to the text files with a speech synthesizer—but everybody can use them to make exploring back issues easier. You could load an issue or two into AppleWorks, for example (each issue is about 60K), and search for topics that interest you, or use a document-retrieval program such as Jim Hammond's amazing **FastData Pro** (available from *A2-Central* for \$49.95) to search through a number of files at the same time.

No Apple II user needs to be convinced of the value of *A2-Central*: For almost five years Weishaar and his staff have been solving real problems for real people, and at least half of each issue is devoted to readers. It's truly an exchange of Apple II discoveries.

If you like the format, you can also subscribe to *A2-Central* on disk. It costs \$84 for 12 monthly issues, but you get the entire text on disk, the entire text on paper, and a lot of other goodies on disk, such as the latest versions of Apple system software, new public-domain and shareware software, and even some good data files.

Send your orders to *Open-Apple*, P.O. Box 11250, Overland Park, KS 66207, or open a subscription to *A2-Central* (only \$28 a year) and receive a free monthly catalogue. Circle number 351 on your Reader Service card for more information.

—P.S.



SOFTWARE

NO DUSTY ERASERS

Tom Snyder's latest contribution to classroom software, **All Star Drill**, turns a computer with a large screen or LCD system into a “smart chalkboard.”

All Star Drill lets teachers review information with an entire class in an exciting **baseball-game format**. The “smart chalkboard” displays questions to the entire class. Students come “up to bat” and answer the questions, scoring hits and runs for their teams. The software displays compelling graphics and keeps score.

Like all Tom Snyder classroom programs, All Star Drill is built for the teacher. Instructors in science, geography, language arts, math—any subject at all—can put students to work with All Star Drill.

On 5¼- or 3½-inch disks, All Star Drill costs \$69.95, and is suitable for grades K–12. Call or write Tom Snyder Productions, 90 Sherman Street, Cambridge, MA 02140, (617) 876-4433, or circle number 352 on the Reader Service card.

—P.S.



GAMES

HEAVY ARMOR

The year is 1992. Military technology has reached a new peak, and you control the best helicopters, tanks, and infantry units. **Overrun** throws you into battle for control of the Middle East or Europe.

Based on the same game system developed for two of SSI's other hits, **Panzer Strike!** and **Typhoon of Steel** (created by noted game designer Gary Grigsby), **Overrun** lets you play any of eight included scenarios, or create your own. Three depict actual Arab-Israeli battles of 1973; other scenarios predict future skirmishes with advanced weapons in 1992 between Arab and Israeli forces or NATO and Warsaw Pact nations.

Keep your territory from being overrun. Put yourself in command for \$49.95 from Strategic Simulations, Inc., 1046 North Rengstorff Avenue, Mountain View, CA 94043, (415) 961-6716. Circle number 362 on the Reader Service card for more information.

—L.L.

GRAPHIC PUBLISHING / HIGH-IMPACT PRESENTATION GRAPHICS IS NOW AVAILABLE TO APPLE IIE, IIC, AND IIGs OWNERS WITH TIMEWORKS' CHARTING PROGRAM GRAPH IT!.

Graph It! converts numerical data from your spreadsheets or databases to clear **charts for display**. You can also enter numbers directly into Graph It!'s built-in spreadsheet templates. Graph It! converts files quickly from AppleWorks and DB Master, two of the most popular Apple II databases.

You can print Graph It! charts on your printer (in color if you've got an ImageWriter II) or export graphs to disk for use in Timeworks' Publish It! or any other program that uses the

standard Apple Graphics File format.

Graph It! graphs and charts come in more styles than you'll ever need: column, bar, scatter, 3-D—12 of the most-asked-for formats. With Graph It!'s Apple interface, you simply point and click to add borders, legends, and titles. (A mouse is strongly recommended, but not required.)

Graph It! sells for only \$69.95. Contact Timeworks, 444 Lake Cook Road, Deerfield, IL 60015, (312) 948-9200, or circle number 350 on the Reader Service card for details.

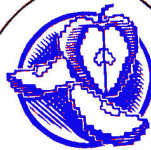

APPLE BITS

●Jan Davidson's husband, Robert Davidson, has been named chairman and CEO at **Davidson and Associates**. Nepotism? No, Bob has degrees in engineering and law, plus an M.B.A. Jan hopes to devote her time to product development, Bob to marketing and finance.

●Banned Near Boston: A prestigious textbook and software publisher on Route 128 refused to negotiate a possibly profitable deal for some of its games with **Nintendo**, because a Nintendo partnership might compromise its name, noted for quality.

●The big **retail chains** were sending lots of software back to the manufacturers in early summer.

●**CMS** (Tustin, CA) may have had it with its Apple II hard-disk drive—too difficult to support its proprietary interface.

●Peter Doctorow, **Accolade** veep, likes the thrill of the European shows—especially the personal-computer shows in London. "Excitement's what's lacking here," Doctorow noted at Comdex in Chicago last April. Accolade now does all its own distribution in the old countries.

●**Imposters** claiming to represent Apple Computer have been visiting software publishers in Silicon Valley and asking them not to develop any more software for the Apple II. The FBI has been alerted, but has John Sculley?

●Davidson's latest, **Math Blaster Mystery**, must have been a hurdle for the Davidson stable of programmers: It features animated graphics in addition to impeccable mathematics. Davidson still does all its programming in house.

●Authorized Apple dealers who sign up for affiliation with **MicroAge Computer Stores** (Tempe, AZ) may offer lower prices on Apple equipment, but then again they may not: Some stores may use their savings to improve tech support and customer service.

●**Tetris**, the Soviet game that came to the United States on the Apple II, will soon be available for Nintendo.

●John W. Schurmeier Jr., an alert reader in Cottage Grove, MN, noted that the reference manual for Broderbund's **VCR Companion**, published in 1988, has this prophetic statement on page 21: "Genlock boards allow you to overlay your video script onto an existing image." At that time there was no Apple II genlock; today there's Apple's Video Overlay Card. Did Broderbund know something we didn't?

●Look for an arcade adventure with—naturally—great graphics from **Polarware** soon.

●Look for the hard-disk drives manufactured by **American Micro Research** (Chino, CA) at your favorite mail-order dealer's soon—they're fast, reliable, and cheap.



**REMOVABLE
HARD DRIVES**

The small-computer-systems interface (SCSI), an industry standard, is

making it easier for Apple II owners to find *removable hard-disk drives*.

American Micro Research (13505A Yorba Avenue, Chino, CA 91710, 714-590-3900) and *Crate Technology* (6850 Vineland Avenue, Building M, North Hollywood, CA 91605, 818-766-4001), both make 45-mega-byte drives for the Macintosh that work fine hooked up to Apple IIs with SCSI ports. Circle numbers 353 and 354, respectively, on the Reader Service card for more information. —P.S.

I THINK I CAN

Exciting opportunities for severely disabled people fill the pages of the **DU-IT Control Systems Group** catalogue. Quadriplegics with high-level spinal-cord injuries are often paralyzed from the shoulders down, but retain precise control of head and face movements, for example, making computer operation possible. For more information on DU-IT's adaptive hardware products, circle number 359 on the Reader Service card. —P.S.

RESOURCES

THAT'S THE BOOK FOR ME

Thousands of computer bulletin-board systems (BBSes) are lurking out there, awaiting your call. The trouble is knowing which one to call when.

The **BBS Bible** has the answers: It's a comprehensive listing of almost 5000 BBSes in the United States. In addition to all those phone numbers organized by area code (which helps you find a local board), the **BBS Bible** also groups them



by interest (more than 130 areas); the roster includes boards on specific kinds of computers and boards for fans of ham radio, genealogy, music, the arts, and all kinds of other passions.

The idea is that "there's a BBS for everyone." The **BBS Bible** has the details for only \$24.95, from Bubeck Publishing, P.O. Box 104, Collegeville, PA 19426, (215) 287-6356, or circle number 355 on the Reader Service card.

—P.S.

HELP FOR THE MASTERS

If Epyx's **Masters Collection** of games—**The Legend of Blacksilver**, **Sub Battle Simulator**, **Space Station Oblivion**, and **L.A. Crackdown**—have mastered you and you're looking for help, look for the **Masters Collection Hint Book**.

The **Masters Collection Hint Book** costs only **\$7.99** and includes such features as complete maps of the **16 towns**, **40 levels**, and **22-part labyrinth** of the **Legend of Blacksilver**.

In addition to the maps and game-play suggestions for all four games, fascinating interviews with the programmers and other background details fill out the **Masters Collection Hint Book**. It's available at retail stores, or from Epyx, **600 Galveston Drive, P.O. Box 8020, Redwood City, CA 94063**. For the story of the complete line of Epyx games, circle number **356** on the Reader Service card. —P.S.



RESOURCES

TELL 'EM WARE TATTLER

Bob Kerr couldn't wait. "I have been frustrated by the lack of information resources for answering questions about technological solutions to the problems of special-needs children and adults," he wrote in the first issue of the *Tell 'Em Ware Tattler*, the newsletter he now publishes for the special-needs community.

Tell 'Em Ware (1714 Olson Way, Marshalltown, IA 50158) also publishes an AppleWorks database of special-needs resources (\$39.95) and two sets of public-domain special-needs software for grade-school and older kids (\$49.95 each). The *Tell 'Em Ware Tattler*, \$7.50 for four quarterly issues, is far more than a catalogue of Tell 'Em Ware products, though; it publishes articles that describe how to use adaptive technology and how to pay for it. The *Tattler* also accepts and answers readers' questions. Circle 358 on the Reader Service card. —P.S.

FREE FARM SOFTWARE

High-tech farmers know the **AG/PAC** name—since 1967 AG/PAC has grown software solutions for dairy, swine, beef, and crop management, plus market charting, real-estate investment, farm accounting, and recordkeeping.

AG/PAC is so certain that one of its

recently redesigned programs is perfect for you that it's willing to send you a free farmer's financial disk just for asking for a catalogue.

Call AG/PAC at 800-US-AGPAC for details or write to 427 Grand Canyon Drive, Madison, WI 53719. Circle number 357 on the Reader Service card for more information. —P.S.

BASIC & Assembler NEWS

Ariel Publishing (P.O. Box 266, Unalakleet, AK 99684, 907-624-3161) now publishes two monthly Apple newsletters: ZNews and The Sorcerer's Apprentice.

ZNews is a cooperative venture with Zedcor, publisher of the programming language ZBASIC. It'll feature Gary Morrison (RepairWorks) and Jay Jennings (ProTools, MiniBase), as well as the Gariepy brothers, creators of ZBASIC. ZNews will be the primary platform for ZBASIC programming discussion. It costs \$36 per year; a companion disk is \$20.

The Sorcerer's Apprentice, produced in association with Roger Wagner Publishing, is the assembler journal for Merlin programmers. Glen Bredon (ProSell), Jerry Kindall (MicroDot), Jeff Smith (Roger Wagner Publishing), and even Bob Sander-Cederlof (editor of the late Apple Assembly Lines) will contribute regularly. Cost is only \$28 for 12 monthly issues (companion disk, \$20).

Serious programmers can get more information by circling number 361 on the Reader Service card. —P.S.

●Version 2.0 of the **Hard Byte Editor**, a utility program for Sider hard-disk drives, has an all-new search function and an improved 80-column sector editor. Write to Subtle Solutions, 314 South Red Lion Terrace, Bear, DE 19701.



UPDATES

●Apple's (Cupertino, CA) **enhanced ImageWriter LQ** improves print quality, is quieter, and now comes with a quick-setup guide. If you bought your printer between August 11, 1987, and March 7, 1989, your printer dealer will exchange your old noisy model for a new quiet one.

●**Dollars and Sense**, the popular personal-accounting program from Monogram (Torrance, CA), is now available in a ProDOS version. Registered users can get the upgrade, which now lets you install the program on a hard drive, for \$39.95 (regularly \$119.95). Call (213) 533-5120.

●**Claris Corporation**, publishers of AppleWorks, AppleWorks GS, and software for other computers, has moved to 5201 Patrick Henry Drive, P.O. Box 58168, Santa Clara, CA 95052-8168.

●License any **First Byte** (Long Beach, CA) product—Talking Notebooks or Building Blocks for Learning, for example—for your school for only \$250. Order a site license before October and you'll receive SmoothTalker, First Byte's talking word processor, free.

●**Mindscape's** (Chicago, IL) most popular educational products are now available in Apple II versions for Control Data's **Omninet** network (formerly Corvus).

●**Custom Computer Products** (Costa Mesa, CA) has taken over the popular database manager **ProFiler** from Pinpoint Software. ProFiler version 4.0 has lots of new features and a completely rewritten user's manual. For details call (714) 548-5429.



STATTUS REPORT

IN WORTH AND CHOICE

By PAUL STATT • SENIOR EDITOR

The best teachers don't beg the best tools; the best teachers know what they want to teach and why.

I QUIT TEACHING NOT BECAUSE MY STUDENTS weren't learning any algebra, but because I couldn't convince myself they ought to know it.

Every teacher still in the business has somehow survived that moment of doubt. Standing alone before 30 children, who may or may not care what you have to say, you must make up your mind about what you're going to try to cram into theirs.

Much "educational technology"—books, magazines, movies, filmstrips, worksheets, cassette tapes, overhead transparencies, and, yes, *computer software*—relieves the teacher of the burden of choice: "What should I teach?"

"What should children learn?" is a question many parents prefer not to answer: Put the kids on the bus and let the school decide. But many teachers beg the question as well, looking for answers—such as standard curricula and textbooks—from the department head, the principal, the school district, the state board of education, or even the Secretary of Education in Washington.

The best teachers don't beg the best tools; the best teachers know what they want to teach and why. Tools are no substitute for commitment.

If you're an insatiable reader, for example, your literature, writing, reading, English, and language-arts classes will show it; you won't require any software. (And you're the only kind of teacher fit to use educational technology intelligently.)

If, on the other hand, you never grasped long division, and never believed you needed to, "Quest for Quotients"—the newest arithmetic software—won't help. Commitment comes first. If you're committed to a topic you love to teach, picking the software is easy—ask yourself, "Do I like it?"

But what do the experts advise? "Your goal is to obtain an easy-to-use, instructionally sound program that takes full advantage of the unique capabilities of the computer—interaction, branching, graphics, and sound—and is free from errors or 'bugs,'" says the author of *Evaluating Educational Software: A Guide for Teachers* (Prentice-Hall, Englewood Cliffs, 1989).

The "unique capabilities of the computer" are reduced to something resembling a stereo television set with remote control. All media are interactive, or they're not *mediating*. Arkanoid is highly interactive, branches, looks like MTV, and sounds like *Star Trek*. But I'm an addict, and even I can't maintain with a straight face that it's educational.

David Dokterman, author of *Teaching in the One-Computer Classroom* (Tom Snyder Productions, Cambridge, 1989), has studied the history of "educational technology" from the chalkboard through movies, radio, and television to the computer. He's not easily impressed. His view isn't clouded by a rosy image that after the "computer revolution" he can stop asking himself the hard questions: "What do you do and what do you want to do in the classroom? . . . 'Why do I teach this?' and 'Why do my students need to know that?'" (Your students certainly don't hesitate to ask these questions, whether you hear them or not.) The question is simple. What do you want to teach?

Children are supposed to "learn to read" by watching *Sesame Street*. What they actually learn is to watch TV. I doubt whether children learn to estimate how much sales tax they'll pay on a \$20 album by playing arithmetic games. They learn to play arithmetic games. What do you want to teach?

Good educational software forces kids to do what you want them to learn to do. Students can't help but program computers, for instance, if they use the language Logo. They can't play Broderbund's Carmen Sandiego games without researching facts in *The World Almanac*. They must think if they want to simulate an exploration of the United States, as in Tom Snyder's National Inspirer.

But don't bother trying to light a fire under your kids unless you're burning yourself. Children learn by watching adults. If you enjoy playing National Inspirer, the kids will know it. Teaching what you love and believe in is automatic.

In English, "evaluation of educational technology" means, "Buy software that teaches what's worth learning." What's worth learning? I still don't know, and I still wish I did. But you're still teaching. □



Live Long and Prosper

Permit us a logical prediction. With Vulcan,[™] the Apple II series will continue to live long and prosper. Applied Engineering's latest triumph, Vulcan, lives!

Vulcan high-speed internal hard disks for the Apple IIGS, IIe and II+, combine high speed flexibility and ease-of-use with sheer, raw power. The result? A quantum leap forward into the Apple II future.

Stop that infernal disk swapping and file splitting and store your massive new mega-programs on Vulcan. Speed up booting and access time while you save wear and tear on your disk drives.

Flexibility.

Choose a Vulcan from 20, 40, 100—all the way to a staggering 200 MEGs. Your Vulcan can grow as your needs grow. Start with a Vulcan sized for your current needs and upgrade to a bigger size later. Use virtually any operating system: GS/OS, ProDOS 8, DOS 3.3, CPM or Pascal 1.3. Vulcan supports them all. Choose your own partitioning scheme. Sixteen partitions with

four accessible simultaneously. And partitioning and backup utilities are included. Choose an available slot. 1, 2, 4, 5, 6 or 7. Even pseudo-slot to slot 7 from another slot. Vulcan understands.

Sheer, raw power.

Vulcan's built-in power supply checks in at 70 watts. That's nearly twice the capacity of competing systems. A truly heavy-duty power supply with enough punch to safely handle a motherboard full of expansion cards. To harness all that power, Vulcan contains an ultra-quiet cooling fan. For speed, Vulcan incorporates a 16-bit data bus controller, not an 8-bit like others.

Ease of use.

Vulcan lives in the space the stock, Apple power supply formerly occupied under your Apple's hood. Just pop out the old one, slip Vulcan into its place, plug in the expansion card and connect one cable.

Your Apple II is finally ready to go up against the big boys.

Order today!

To order or for more information, see your dealer or call (214) 241-6060 today, 9 am to 11 pm, 7 days. Or send check or money order to Applied Engineering. MasterCard, VISA and C.O.D. welcome. Texas residents add 7% sales tax. Add \$10 outside U.S.A.

| | |
|--------------------------------|--------------|
| Vulcan 20 MEG | \$649 |
| Vulcan 40 MEG | \$849 |
| Vulcan 60-200 MEG | CALL |

AE APPLIED ENGINEERING[®]

The Apple enhancement experts.

A Division of AE Research Corporation.

(214) 241-6060

P.O. Box 5100, Carrollton, TX 75011

Prices subject to change without notice.



CLINIC ADMISSIONS

inCider's Apple Clinic is now *the* leading resource for answering your technical questions about Apple IIs and related hardware and software.

By **WILLIAM P. KENNEDY, Ph.D.**

NEW CLINIC POLICY

YOU'VE HEARD THE NEWS: *A+* and *inCider* have merged. *inCider*, with *A+* incorporated, is now *the* leading Apple II magazine. Consequently, *inCider's* Apple Clinic becomes *the* leading resource (I think it always has been) for answering technical questions about Apple IIs and related hardware and software.

Since becoming *inCider's* technical editor, I've tried to answer all Clinic inquiries, even those phoned in. I've selected questions for publication that addressed generally interesting issues, while answering the rest via letter or postcard.

With the recent merger, however, the number of Clinic questions has increased significantly. We want to continue providing the best service to our readers, but the consequent workload has become overwhelming. So, it should come as no surprise that we're forced to rethink our personal-reply policy and ask for your support by following a few simple guidelines when writing:

- Address your letters to Apple Clinic, c/o *inCider*, 80 Elm Street, Peterborough, NH 03458, to receive serious consideration for a published answer.
- Enclose a self-addressed, stamped envelope (SASE) to receive a personal reply.

- State your problem simply and include only the relevant details, such as which Apple you're using with related software and hardware accessories.

- If you have a question about a program that isn't generally available (a game you wrote yourself, for example), send along a printout of the program *and/or* a disk.

- Approach the manufacturer of the product you're considering purchasing or with which you're having trouble.

- Or consult your local dealer or user group. They can often answer your questions in a more timely and comprehensive way than I can via postcard.

Thanks. And don't forget to send along your Clinic Quickie tips.

Bill Kennedy
Apple Clinic Editor

MAGIC GRAPHICS

IPURCHASED ACTIVISION'S (now Mediagenic's) *Aliens* game recently for my Apple IIc. I was surprised to find that the program can display many more colors—such as gray, yellow, and red—than I usually get using BASIC. How does Mediagenic do that, and how can I reproduce it in my programs?

Suzanne Werner
North Brunswick, NJ

It's magic, pure and simple. That's how.

No, really, Aliens and a lot of other games and graphics-intensive programs designed for the Apple IIe and IIc use what is termed double-high-resolution (double-hi-res) graphics video mode to produce the colors you mentioned and at least 13 others.

Double-hi-res video is something of an artifact of the 80-column-text hardware introduced originally with the IIe.

Some tinkerer discovered, to the surprise of many Apple II engineers, that a minor modification in the original IIe motherboard (Revision A alone can't produce the effect), along with an "extended" 80-column text card (adds 80-column text and 64K of RAM) whose Molex connector pins are "jumped," plus the right combination of video hardware "soft switch" settings (see the accompanying Table), ►

| SOFT SWITCH | MACHINE LANGUAGE | APPLESOFT BASIC |
|-------------------|------------------|-----------------|
| GRAPHICS | STA \$C050 | POKE 49232,0 |
| HIRES | STA \$C057 | POKE 49239,0 |
| BOCOL | STA \$C00D | POKE 49165,0 |
| AN3 (off) | STA \$C05E | POKE 49246,0 |
| MIX (text window) | STA \$C053 | POKE 49235,0 |
| NOMIX | STA \$C052 | POKE 49234,0 |
| BOSTORE | STA \$C001 | POKE 49153,0 |
| PAGE1 | STA \$C054 | POKE 49236,0 |
| PAGE1X | STA \$C055 | POKE 49237,0 |

Table. Enabling double-hi-res video-display mode.

DISK ACCELERATOR

THE MULTI-KACHE CARD



If you're using an Apple computer, saving time is more than a priority...it's a necessity. Speed is critical, and nothing irritates you more than waiting for your disk drives to play catch-up.

OKS has come up with a solution. The Multi-Kache Card. An intelligent multi-disk controller so fast...so powerful...so efficient...it will unleash performance you didn't even know you owned.

Let the facts speak for themselves:

1. The Multi-Kache Card is the fastest disk controller available for Apple computers!
2. The Multi-Kache Card is twice as fast as a ramdisk—and safer!
3. The Multi-Kache Card is up to 40 times faster than other controller cards!
4. With our 30-day trial period you can experience the Multi-Kache Card for yourself with no risks!

The OKS Multi-Kache Card is a multi-disk controller with real hardware cache. With the combined features of a disk controller and real cache memory, the Multi-Kache Card boosts throughput of your data to and from your computer.

The Multi-Kache Card performs without taking up any system memory.

Applications which access your disk drives frequently, such as a large data base will demonstrate dramatic speed improvements. And the Multi-Kache Card's real cache memory can extend the life of your drives.

The Multi-Kache Card controls both 3.5 and 5.25 drives and runs at 8MHz.

Check these features:

- The Multi-Kache Card can read an entire 3.5 disk from cache in 3.5 seconds
- can run the ProDOS 16 Launcher from cache in under 15 seconds
- will control up to 8 assorted disk drives
- can daisy-chain disk drives
- can reduce or eliminate slot congestion on the market
- is compatible with all accelerators currently on the market
- is a SMARTPORT device that is 100% compatible with ProDOS 8/16, and GS/OS
- is compatible with Apple II+, IIe, and IIGS

The OKS Multi-Kache Card comes standard with 256K of cache memory and can be upgraded to a full 1 meg.

The Multi-Kache Card can control any combination of the following types of disk drives:

- The Apple Unidisk 3.5 Disk Drive
- The Apple GS 3.5 Disk Drive
- The Apple 5.25 Duodisk
- The older 5.25 Disk II Disk Drive
- The Apple 20SC SCSI Hard Disk Drive
- The Apple 5.25 Drive

For more information call us toll free at

1-800-338-0050



Ohio Kache Systems Corp.
4162 Little York Road, Suite E
Dayton, Ohio 45414-2566
513-890-3913

Multi-Kache Card is a registered trademark of Ohio Kache Systems Corp.
Apple II+, IIe and IIGS are registered trademarks of Apple Computers, Inc.

Program listing. Demo, double-hi-res graphics mode.

```

10 REM Double Hires Graphics Demo [5288]
20 REM by William Kennedy [3553]
30 REM Copyright 1989, inCider [4733]
40 REM Enable double hires [3839]
50 PRINT CHR$(4);"PR#3": HOME : POKE 49235,0 [2387]
60 POKE 49239,0: REM hires [1834]
70 POKE 49232,0: REM graphics [2652]
80 POKE 49165,0: REM 80-columns [2851]
90 POKE 49246,0: REM AN3 off [2695]
100 VTAB 22: PRINT "Screen should have lots of garba
ge above and this message in the text window." [6150]
110 GOSUB 1000 [1256]
120 HOME : VTAB 22: PRINT "Now clearing a portion of
graphics pages 1 and 1X to black..." [13035]
130 POKE 49153,0: REM Turn on 80Store [3314]
140 POKE 49236,0: REM access Page 1 first [4219]
150 C1 = 0: C2 = 0: GOSUB 1500 [1536]
160 POKE 49237,0: REM Now enable Page 1X [4110]
170 GOSUB 1500: REM and clear it. [3071]
180 PRINT : GOSUB 1000 [1006]
200 REM Draw color stripes [1520]
210 HOME : VTAB 22: PRINT "Color bars now will appea
r on page 1 and turn solid when placed on page 1X
..." [6685]
220 PRINT : PRINT TAB(8)"Press space bar to pause,
esc key to quit..."; [3518]
230 RESTORE : FOR C = 0 TO 15: REM 16 colors [2206]
240 S = 1: READ C1,C2: POKE 49236,0: REM Page 1 [4438]
250 GOSUB 1500: IF PEEK(49152) > 127 THEN 300 [2388]
260 S = 2: READ C1,C2: POKE 49237,0: REM Page 1X [2862]
270 GOSUB 1500: IF PEEK(49152) > 127 THEN 300 [3876]
280 NEXT C: GOTO 230 [1010]
300 GET A$: IF A$ = " " THEN GET A$: GOTO 320 [3135]
310 IF A$ = CHR$(27) THEN TEXT : HOME : PRINT "By
e...": END [4362]
320 ON S GOTO 260,280 [756]
1000 VTAB 24: PRINT TAB(12);"Press the space bar t
o continue -->"; [3086]
1010 GET A$: PRINT A$: RETURN [1317]
1500 REM Put color bytes onto graphics page [2365]
1510 FOR I = 0 TO 19: FOR J = 0 TO 7 [1878]
1520 POKE I * 2 + 8960 + J * 1024,C1 [2034]
1530 POKE I * 2 + 8961 + J * 1024,C2 [2040]
1540 POKE I * 2 + 9088 + J * 1024,C1 [3035]
1550 POKE I * 2 + 9089 + J * 1024,C2 [3153]
1560 NEXT J: NEXT I [785]
1570 RETURN [193]
2000 DATA 17,68,8,34,8,34,68,17,25,102,76,51 [3578]
2020 DATA 68,17,34,8,85,85,42,42,76,51,102,25 [3702]
2030 DATA 93,119,110,59,34,8,17,68,51,76,25,102 [3829]
2040 DATA 42,42,85,85,59,110,93,119,102,25,51,76 [4000]
2050 DATA 119,93,59,110,110,59,119,93 [4519]
2060 DATA 127,127,127,127,0,0,0,0 [3884]

```

In the meantime, I've prepared a demo that uses Applesoft BASIC (see the accompanying **Program listing**) to exercise double-hi-res video. You'll notice that the program consists basically of three parts: Enable double-hi-res (lines 60-90); demonstrate main (page 1 in the first, or lower, 64K of RAM) and auxiliary (page 1X in the second, or upper, 64K of RAM) graphics bit-map memory access (lines 120-180); and display the 16 available colors (lines 200-280).

The subroutine in lines 1500-1570 calculates the RAM addresses for a portion of the bit map near the center of the graphics screen and POKEs the alternating color bytes into it.

The DATA in lines 2000-2060 contain the repeating 4-byte bit patterns that produce the 16 basic colors of double-hi-res video. While examining those DATA values, keep these facts about the double-hi-res screen in mind. The last 4 bits, or nibble (bits 4-7), in the corresponding byte of the page 1X graphics bit map specifies the pixel in the leftmost column on screen. The next pixel to the right is the remaining nibble (bits 0-3). The next two pixels correspond similarly to page 1 graphics RAM, and so on, alternating between pages 1 and 1X.

Also, the bit patterns for color alternate in 4-byte sequences—2 each for pages 1 and 1X. That's why line 260 READs two byte values and lines 1520-1550 POKE them into adjacent bytes of graphics RAM, alternating between pages 1 and 1X.

Thoroughly confused? I told you it's complicated. But, once you get the hang of it, you'll probably want to write several subroutines that translate some rational coordinate system for the screen (x = 0-159 and y = 0-191, for example) into a specific pixel's address and color automatically. When you do, please share it with all of us.

QUICKIES

AppleWorks 2.1 patches to skip the spacebar and date entry: POKE 14118,44: POKE 14436,208: POKE 14437,19.

**—Patrick Cox
Bennettsville, SC**

APPLE CLINIC IS A FORUM FOR ANSWERING YOUR QUESTIONS ABOUT APPLE II HARDWARE AND SOFTWARE. ADDRESS YOUR CORRESPONDENCE TO APPLE CLINIC, inCIDER, 80 ELM STREET, PETERBOROUGH, NH 03458. BECAUSE OF THE VOLUME OF LETTERS, MOST WON'T APPEAR IN PRINT, BUT WE'LL TRY TO RESPOND IF YOU ENCLOSE A SELF-ADDRESSED, STAMPED ENVELOPE.

enables double-hi-res video—that is, a 16-color, 160-horizontal-by-192-vertical-pixels graphics mode. You also need a minimum 12-megahertz color monitor. Later IIe motherboards incorporate the modification, and double-hi-res video is built into the Apple IIc, IIc Plus, and IIGS.

Enabling double-hi-res video is simple. Drawing on it, however, is complicated. Similar to standard hi-res, the RAM addressing ("bit map") for each of the graphics elements in double-hi-res doesn't cor-

respond directly to a pixel's position or color on screen. But Applesoft BASIC doesn't include support commands for double-hi-res as it does for hi-res; lots of PEEKs and POKEs must suffice.

A complete discourse is beyond the scope of this column, but you can read more about the intricacies of double-hi-res video in any of Addison-Wesley's (6 Jacob Way, Reading, MA 01867) IIc, IIe, or IIGS technical manuals, which you'll find in most popular bookstores.



APPLIED ENGINEERING

A DIVISION OF AE RESEARCH CORPORATION

Dear Apple lover,

I guess it's obvious from our product names that I'm a space buff. One of the most fulfilling moments of my life was being at Cape Canaveral to witness the space shuttle Atlantis lift off carrying the Magellan space probe on the first leg of its journey to Venus.

How wonderful to live in the United States, where we place so high a value on discovery and exploration. This July 4th, it's been 20 years, nearly to the day, since that spine-tingling radio transmission from the moon announced: "Houston, Tranquility Base here. The Eagle has landed." The 4th of July is a good day to stop and consider that this American need to learn, discover, explore and invent is rarely inspired by profit. Something much more instinctive is going on.

When Americans design an electric light, or an airplane, or a spacecraft or a cold fusion reactor, the motivation usually comes from the challenge of confronting a problem and the satisfaction of solving it.

I've always been fascinated with technology. I've gone from tinkertoys to 1/6 scale radio-controlled jet aircraft. But one of my hobbies hasn't changed. My first love is computers and my passion is the Apple II. I'm very lucky—my work *is* my hobby.

Applied Engineering is an assembly of people who feel the same way. The company is driven by research and development. Engineers outnumber salespeople 3 to 1. And our engineers rarely talk about the possible profits a new product might bring. They're more concerned with exceeding your expectations. Designing and building the best products on the market. Never settling for second best. And that's the way I want it. I couldn't be more proud of them.

Together, we have a vision for the Apple II and over 100 products are making that vision come true, but we're not finished yet. This year, we're expanding our R & D department by more than 20% so we can continue to develop new products and improve existing ones. We were in search of excellence before it was fashionable. Excellence in engineering, in manufacturing, in technical support and in service. We know we're not perfect, but we are committed to constantly improving.

H.G. Wells once wrote, "Rest enough for the individual. Too much and too soon and we call it death, but for man, no rest and no ending. He must go on, conquest beyond conquest. First this little planet and then all the laws of mind and matter that restrain him. Then the planets about him, and at last out across the immensity to the stars, and when he has conquered all the deeps of space and all the mysteries of time, still he will be beginning. For if we are no more than animals we must snatch each little scrap of happiness and live and suffer and die. Mattering no more than all the other animals. It is this, or that. All the universe or nothing. Which shall it be? Which shall it be?"

Have a safe and happy 4th of July.

Sincerely,

Danny W. Pote
Founder & Chairman, Applied Engineering

(214) 241-6060 P.O. Box 5



REVIEWS

INCIDER'S RATINGS

Excellent—remarkable ♦♦♦♦♦ Very good—impressive ♦♦♦♦
Good—average ♦♦♦♦ Fair—flawed ♦♦♦♦ Poor—unacceptable ♦♦

ART & FILM DIRECTOR



EPYX,
600 Galveston Drive, Redwood City, CA
94063, (415) 366-0606
Paint and animation program;
768K Apple IIgs, 3½-inch disk drive; \$79.95
Rating: ♦♦♦♦

Epyx, a leader in the entertainment business and producer of several effective graphics products, now steps into the limelight with a new, sophisticated paint and animation package—Art & Film Director.

As the name implies, Art & Film Director is actually two programs in one—each of which could easily stand alone as a separate product. While both modules boast easy-to-use interfaces, making the program suitable for novices

and amateurs, a perusal of the package's advanced features makes it clear that this program is intended for the serious computer artist.

GETTING CREATIVE

The Art Director program contains every conceivable feature the would-be designer could want—a drawing pencil with 40 different points; shape tools to create perfect geometric forms; 4096 colors from which to build

your palette; special effects that let you stretch, bend, rotate, and outline your drawing; and so on.

Anyone who's the least bit familiar with paint programs is aware of the plethora of features most of them offer. Art & Film Director, however, holds its own not only in number of options, but also in ease of use.

DETAILS, DETAILS

For example, in the upper left-hand corner of the Art Director screen is a rectangular window called the Zoom Box, which you can toggle on and off for detail work. The Zoom Box magnifies the canvas area where your cursor is positioned; the magnified area changes each time your cursor moves, constantly monitoring and mirroring the cursor's position.

Furthermore, the Zoom Box is "active," letting you use it for detailed drawing or fine editing. You can set eight levels of magnification, allowing for total control of your creation.

Certainly any good paint program contains some sort of magnification. Getting to it is often a several-step procedure, though. You may lose the rest of the picture while working on a specific segment in magnification mode, and levels may be limited. Art & Film Director, by treating the zoom as a separate and continuously active window, enhances this essential feature.

THE BRUSHOFF

Ease of implementation seems to be a rule of thumb in Art & Film Director. Almost every aspect of the program contains numerous options and all of them can be selected with the mouse or keyboard. The program is strongly geared toward the mouse interface and responds with admirable control and sensitivity when you draw or select options from the numerous pull-down menus and windows. ▶



An Available kind of hard disk from Applied Ingenuity

And it is like no other hard disk you've ever seen before. While some were tinkering, our engineers sunk their teeth into the project, and with ingenuity we innovated the first and only internal hard disk for the Apple IIs. (A IIe version is also available).

This available line of internal and external hard disks from Applied Ingenuity has achieved higher performance with the fastest transfer rate, the easiest hard drive to install, and of course the most affordable hard drives ever - this is something the other guys have trouble achieving - and the performance is always getting better. Inner Drive is 100% compatible using the standard ProDOS and GS/OS operating systems. It comes with a comprehensive manual and over 3 meg of free software.

We may not be the biggest fish in the Apple market but as with the recent episode of A+ Magazine, even the big guy on the block may turn out to be a 'memory tomorrow'.

When a hardware company says 'we hate vaporware' they really mean, 'we wish we came out with it first'. Webster defines vaporware as - a product that is now being advertised while not yet available. Well, we do advertise upcoming products like everyone else, because 'inquiring minds want to know'.

Anyone can 'engineer' a high cost product, but it takes Ingenuity to make quality and performance affordable.

Loads AppleworksGS all modules in 15 Seconds, using GS/OS v5.0 and AppleWorks v2. Don't settle for a high cost imitation. When you want affordable high quality. Who ya gonna call?

Call 800-346-0811 or 818-960-1485

Inner Drive: 20 meg \$499, 40 meg \$699

Over Drive: 20 meg \$399, 40 meg \$599

Applied Ingenuity, Inc

14922M Ramona Blvd, Baldwin Park, CA 91706

See your Dealer.

Any resemblance to characters living or not is purely coincidental.

Photo by Tad Moyer

Circle 54 on Reader Service Card.

REVIEWS

Another standard feature found in good paint programs is the ability to define your brush. Art Director lets you "cut out" a block of color, an image, or even a piece of text with the scissors icon and turn it into a paintbrush. Whatever you've defined as your brush will duplicate its image wherever you move the brush on screen. You can take a single word, for example, turn it into a brush, and "stamp" it all over the screen.

Other advanced features include the Mirror command, which divides the screen into two sections (horizontal or vertical) and makes anything drawn in one section appear automatically in the other.

The Perspective command adds depth to your creation (making railroad tracks realistically narrow as they head into the distance, for example). The Bend command wraps a section of your painting around an imaginary cylinder. This feature lets you wrap a poster around a telephone pole or create cylindrical columns in front of a Southern mansion.

These commands take some time to master. You'll need to experiment with the many special effects and tools to find out how to use them most effectively. You'll need a little patience when experimenting with some of the more powerful commands, such as Bend and Perspective—depending on the size of the object with which you're working and the difficulty level of what you're trying to do, the program can take several minutes to compute and redraw.

ADVANCED GRAPHICS

The Tools menu in Art Director includes the more sophisticated options designed to produce more complex effects, such as scrape, melt, shade, and color merge. You can also use these features to create special effects when working with multiple canvases.

The local/global command works in conjunction with the Tools menu, letting the selected tool work on the entire canvas or on only a selected portion.

After you've created a portfolio of graphics masterpieces, you can display your work in a slide-show presentation. The Art.Show option is simple to use: Copy the Art.Show file from your desktop to any disk containing picture files; insert the picture disk into a drive; click on Art.Show from the directory line; and watch as your pictures appear on screen. Use the spacebar to pause and resume the show.

All in all, Art Director is capable of doing

just about anything you'd want to do in a graphics painting. From a simple line drawing to a computerized version of *The Last Supper*, the tools are available.

Just keep in mind a general rule of thumb—the more sophisticated your creation, the more time, energy, and effort you'll need to complete it.

LIGHTS, CAMERA, ACTION

Film Director is the second half of Art & Film Director, but it certainly doesn't play second fiddle to the paint program in terms of power or array of options.

Film Director uses traditional animation techniques to create cartoons. It accepts drawings created in Art Director (or imported pictures from DeluxePaint, PaintWorks Plus, or PaintWorks Gold) and makes them come alive through animation.

TECHNIQUE IS EVERYTHING

Cell animation is becoming a standard technique among programs of this type because it demands that each frame be made up of its own separate graphics elements, such as background, characters, and props. If one element needs revision, you can change it without redrawing the entire frame.

Another standard device found in Film Director is an animation shortcut called *tweening*, which takes much of the tedium out of creating animated sequences.

Start by creating frame 1—a basketball hoop on a pole and a boy standing below it, holding a basketball at chest level, for instance. Next create frame 10, showing the boy with his arms above his head and the ball exiting the basket. The tweening option in Film Director will automatically create the rest of the frames in between to illustrate the boy shooting the ball.

Much of the power of Film Director is evident in its ability to work with either a single frame or a sequence at one time. This feature lets you make rapid editing changes with minimum difficulty.

For example, suppose you want to add some element to the background you've used in 30 sequential frames. Just call up the sequence command and edit the background in frame 1, then add it automatically to the rest of the frames in the sequence.

ILLUSIONS

Film Director's overlay feature also adds to both its ease of use and its level of sophisti-

cation. *Overlay* lets you duplicate images in different locations within a frame. A single tree blowing in the wind can turn into a forest being pounded by a gale, for instance; then, by copying the entire sequence, you can make the wind lash at the trees for as long as you like.

Layering is yet another option; it places elements over or under others. This technique lets objects pass in front of, behind, or through others to give the illusion of a third dimension.

TRAILERS

While some features are of significant help in the actual design of the film, others such as *trace on/trace off* contribute to the editing process. Toggling the trace-on tool leaves a trail of images on screen as an "actor" moves across it.

For example, if you have a boy dribbling a ball across the screen, each frame will appear and remain as the sequence develops. Then you can analyze the animation and determine which frames, if any, are out of sync.

One last note: No matter what type of film you produce—an epic motion picture or a shot of a bird flying across the screen—you can enhance the visuals with music. The program includes 27 sounds you can copy into your film in several simple steps.

THAT'S ENTERTAINMENT

As with Art Director, you get out of Film Director what you put into it. If you're willing to spend the time it takes to piece together dozens of frames, you can create an impressive film. If you just want to amuse yourself with simple animation, Film Director can entertain you admirably.

Art & Film Director comes on three 3½-inch disks, none of which is copy-protected. The 125-page manual is well written and designed and includes two quick-start tutorials, one for each of the main sections of the program. The table of contents is helpful, but the index could be more complete: Some tools and functions found on submenus aren't listed.

Art & Film Director is an excellent package. To go into all the features contained in this duo is well beyond the scope of a review; suffice it to say that considering the depth of the software and its reasonable price tag, Epyx's contribution to the field of paint and animation is a winning combination.

James V. Trunzo
Leechburg, PA

"COPY II PLUS[®]

WIPED, REFORMATTED AND DELETED ITS COMPETITION!"

-inCider

Disk Utilities • Backup Program for Copy-Protected Disks

- **AWARD-WINNING UTILITIES.**

Over 20 built-in utilities, including the ability to delete and undelete files, map disk usage, copy disks and files, view and print files, format and verify disks, and alphabetize the catalog. Also contains drive diagnostics for checking and adjusting drive speed. Plus much more—all in an easy-to-use menu perfect for both novices and professionals.

- **VERSATILE PERFORMER.** Copy II Plus enables you to convert DOS 3.3 files to ProDOS files and vice versa—automatically.

- **SUPPORTS THE IIgs.** Runs great on the IIgs, and makes full use of Apple 1-Megabyte RAM boards.

- **PROTECT YOUR SOFTWARE INVESTMENT.** Make backup copies of protected and unprotected programs—even those with the most sophisticated protection schemes. Use Copy II and you'll always have a backup handy should anything happen to your original disk.

- **EASY TO USE.** Backup parameters for most programs are already on the disk. Simply select which program you want to backup, insert that program disk and you're off. Data and unprotected disks are copied in less than a minute and require only two passes on an Apple IIc, Laser 128 or IIgs.

Take a look at Copy II Plus today and see why *inCider* magazine says Copy II Plus deleted its competition. For the dealer nearest you, or to order direct, call (503) 690-8090, M-F, 8 a.m.-5 p.m. (West Coast time).

Hardware requirements. Apple II or Laser computer with 128K memory and one disk drive. 3.5-inch bit copy requires Laser 128EX or IIgs (or Apple II computer with Central Point Universal Disk Controller) and a 3.5-inch IIgs, Chinon or Laser drive.

Copy II Plus is a trademark of Central Point Software. Apple II, IIe, IIc and IIgs are trademarks of Apple.



\$39.95

Central Point
Software

INCORPORATED

15220 N.W. Greenbrier Pkwy. #200
Beaverton, Oregon 97006
(503) 690-8090

Programs & Peripherals



Design Your Home Series by Abracadata

Design Your Home is a series of three programs including Architecture, interiors and Landscape. Each program is designed to work as a definitive tool for home design. Draw scaled floor plans; arrange furniture and explore color schemes, and create landscape plans all from top or side views. **\$65 ea.**

ACCELERATORS/RAMCARDS/Z-80/80 COLUMN

| | | | |
|---|------|------------------------------------|------|
| Apple Computer | | GS-Ram Ultra (256K to 4MB) | Call |
| Apple Iie Enhancement Kit | 49. | RamWorks Basic (256K or 512K) | Call |
| Apple Iie Extended 80 Col. Card | 89. | Phasor (II+, Iie, or IIgs) | 139. |
| Applied Engineering | | TransWarp Accelerator (AP or IIgs) | Call |
| RamWorks III (64K to 3 MB) | Call | ViewMaster 80 (II+) | 129. |
| Ram Express (256K to 1 MB) | Call | Z-80 Plus (II+, Iie, IIgs) | 129. |
| Ramkeeper or SlotMover (Option) | Call | Bits & Pieces | |
| PC Transporter (768K) | Call | Rocket Chip | 139. |
| PC Transporter Installation Kit (Iie or IIgs) | Call | Checkmate Technology | |
| RamFactor (256K to 1MB) | Call | MemorySaver (IIgs) | 119. |
| Z-RAM Ultra 1 (256K or 512K) | Call | Orange Micro | |
| Z-RAM Ultra 2 or 3 (256K to 1MB) | Call | RamPak 4GS | 139. |
| GS-RAM (256K to 1.5Meg) | Call | (512k Exp. to 4MB w/Utilities) | 139. |
| GS-Ram Plus (1MB to 6MB) | Call | Zip Technology | |
| | | Zip Chip | 165. |



Revolution '76 by Britannica

It's 1773, and you've had it with British Tyranny. Revolution puts you in charge of America's destiny. Will you be able to overthrow a government and start a new nation? With historically accurate **Revolution '76**, you can do it. But it will take more than just military strength. It also takes political, diplomatic and economic skill. And a bit of luck. Find out if you have what it takes to build a new nation. **\$28.**

PRINTER INTERFACE CARDS

| | | | |
|---|------|--|--------------------|
| Apple SCSI Card | 109. | SMT | |
| Apple Super Serial Card | 119. | No Slot Clock | 42. |
| Applied Engineering Buffer Pro 32K | 95. | Print Tech II (Parallel Interface) | 37. |
| BufferPro 128K or 256K | Call | Thirdware | |
| Serial Pro (II+, Iie, IIgs) | 119. | Finger Print GSI Ver 2 (Includes Desktop Accessories-IIgs) | Special 79. |
| Parallel Pro (II+, Iie, IIgs) | 85. | Orange Micro Grappler C/Mac/GS | 79. |
| Orange Micro Grappler C/Mac/GS | 79. | ProGrappler (Apple Iie or IIgs) | 84. |
| ProGrappler (Apple Iie or IIgs) | 84. | Serial Grappler Plus | 62. |
| Serial Grappler Plus | 62. | | |

COMMUNICATION SOFTWARE

| | | | |
|-----------------------------|-----|--|-----|
| Activision | | Compuserve Compuserve Starter Kit | 24. |
| Teleworks Plus (IIgs) | 66. | United Software Industries | |
| Checkmate Technology | | ASCII: Express Pro: Prodos | 72. |
| ProTERM (IIgs, Iie, Iic) | 95. | ASCII: Express Mousetalk 1.5 | 69. |

UTILITIES & LANGUAGES

| | | | |
|---|-----|---|-----|
| Absoft AC/BASIC (16-bit BASIC Compiler for IIgs) | 84. | The Byte Works | |
| Big Red Computer | | ORCA/M Assembler (IIgs) | 39. |
| PS Lovers' Utility Set (AP or IIgs) | 29. | ORCA/Pascal Desktop Debugger (IIgs) | 80. |
| Micol Systems | | ORCA/C Desktop Debugger (IIgs) | 80. |
| Micol Advanced Basic (IIgs) | 99. | ORCA DeskTop (IIgs) | 34. |
| Roger Wagner SoftSwitch (IIgs) | 39. | TML Systems TML Basic (IIgs) | 84. |
| Merlin 8/16 (Iie, Iic, IIgs) | 79. | TML Pascal (IIgs) | 84. |
| So What Software Disc Commander (IIgs) | 29. | TML Source Code Library (IIgs) | 35. |
| Hyper Launch (IIgs) | 35. | TML Speech Toolkit (IIgs) | 49. |
| | | Zedcor ZBASIS 4.0 Interactive Compiler | 39. |

GRAPHICS PACKAGES

| | | | |
|--|--------------------|---|---------------------|
| Abracadata Design Your Own Train | 35. | Print Shop (IIgs) or Fantavision (IIgs) | 39. |
| Design Your Own Home: Architecture (IIgs) or Interiors (IIgs) | 65. | Print Shop Companion | 25. |
| Design Your Own Home: Landscape (IIgs) | Special 65. | Print Shop Graphics Library I, II, III or Holiday Ed. | 16. |
| Design Your Own Home: Architecture, Interiors or Landscape | 49. | Print Shop Graphics Lib. Sampler Ed. (IIgs) | 24. |
| Architecture Library 1, 2, 3 or 4 (AP or IIgs) | 21. | Print Shop Graphics Lib. Party Ed. (IIgs) | 24. |
| Interiors Library 1, 2 or Landscape Library 1 | 21. | Electronic Arts DeluxePaint II (IIgs) | 65. |
| Activision PaintWorks Gold or Draw Plus Paint/Write/Draw (Not Protected IIgs) | 66. | DeluxeWrite w/DeluxePaint II (IIgs) | 85. |
| Baudville Award Maker Plus (Iie & IIgs) 816/Print (Works On All Applies) | 80. | DeluxeWrite (IIgs) | 55. |
| Berkeley Softworks GEOS (C+) | 79. | EPYX Art & Film Director (IIgs) | 55. |
| GEOS, GEOCalc or GEOFile | 49. | Printmagic (AP or C+) | 34. |
| GEOmouse (AP & C+) | 39. | Create-A-Calendar | 21. |
| Broderbund Dazzle Draw (AP or C+) or Show Off (IIgs) | 39. | Roger Wagner Graphic Exchange (IIgs) | 35. |
| Print Shop (AP or C+) or Fantavision | 29. | So What Software Iconix (IIgs) | 35. |
| | | Springboard Certificate Maker Library #1 | 19. |
| | | Springboard Publisher 2.0 (Iie or IIgs) | 84. |
| | | Certificate Maker or Newsroom | 26. |
| | | Fonts For Springboard Publisher (IIgs) | 19. |
| | | Newsroom Clip Art Collection Vol. 1, 2 or 3 | 14. |
| | | Thunderware Thunderscan Apple (IIgs, Iie, & Iic) | Special 159. |

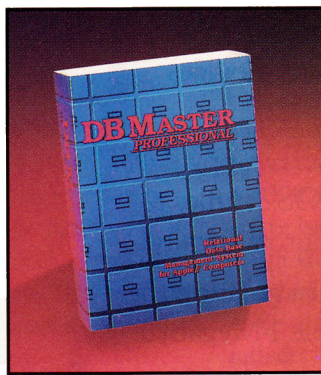

DB Master Professional by Stone Edge Tech

DB Master Professional brings the power of a relational database manager to the Apple II. Anyone who needs to keep track of interrelated types of information can utilize **DB Master Professional** to automate record keeping. Relate up to 10 files for automatic data entry, posting and updating. Includes a full featured reports generator, mail merge, password security and AppleWorks compatibility. **\$195.**

DISK DRIVES & HARD DISK SUBSYSTEMS

| | | | |
|---|------|---|---------------------|
| American Micro Research (Micro Sci) | | Cutting Edge | |
| AMR D20/APS 20MB HD | | XL 30 + SCSI HD (Iie & IIgs) | 539. |
| w/SCSI (Iie & IIgs) | 599. | XL 45 + SCSI HD (Iie & IIgs) | 669. |
| AMR D60/APS 60MB HD | | First Class T6 60MB Tape | 709. |
| w/SCSI (Iie & IIgs) | 829. | D2 20MB HD (Iie & IIgs) | Special 509. |
| A5 D Half Height 5 1/4" Drive (IIgs Daisychain) | 155. | D4/A 40MB HD (Iie & IIgs) | 645. |
| A.5 Half Height (II+ & Iie) | 129. | D4/T 40MB HD/High Perf. (Iie & IIgs) | 855. |
| A.5C Half Height (Iic) | 129. | D9 90MB HD/High Perf. (Iie & IIgs) | 1465. |
| Micro Sci C2 Controller | 52. | D96 Combo 90MB HD & 60MB Tape (Iie & IIgs) | 2155. |
| Applied Engineering Transdrive 360K | 209. | Rodime | |
| Transdrive Dual 360K | 305. | Rodime 20 Plus Ext HD (Iie, IIgs) | 615. |
| Transdrive Half Height 360K | 119. | Rodime 45 Plus Ext HD (Iie, IIgs) | 909. |
| Chinook | | Rodime 60 Plus Ext HD (Iie, IIgs) | 915. |
| CT-20 Hard Drive (AP & IIgs) | 529. | Rodime 100 Plus Ext HD (Iie, IIgs) | 1079. |
| CT-20c Hard Drive Iic | 645. | Rodime 140 Plus Ext HD (Iie, IIgs) | 1325. |
| CT-40 Hard Drive (AP & IIgs) | 715. | Video Technology Universal Disk Controller | 45. |
| CMS "SD Series - Stack" Platinum Iie, IIgs | | Laser DiskDrive (IIgs) | 105. |
| 20 MB w/SCSI II card | 645. | Laser 800KB Drive | 185. |
| 43 MB w/SCSI II card | 845. | Universal Disk Controller/800KB Drive Bundle | 219. |
| 60 MB w/SCSI II card | 950. | | |



ThunderScan by Thunderware

ThunderScan brings high-resolution scanning technology to the Apple II. Just insert the **ThunderScan** cartridge into your ImageWriter printer and your ready to scan. The **ThunderScan** system provides 16 shades of grey, contrast and brightness control. Fully ProDOS compatible, you can export scans to all paint programs for custom editing. **\$159.**

Overnight

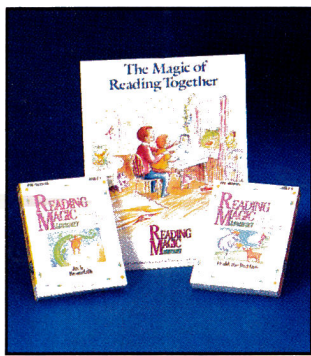

Reading Magic Library by Tom Snyder Productions

Reading Magic Library gives you the first animated interactive storybooks that let your child choose what happens next. Books include **Jack and the Beanstalk**, a whimsical retelling of the fairytale classic, and **Flodd, the Bad Guy**, a delightful fable about an ill-tempered chap who's making life tough for our hero. **Reading Magic** is the perfect way for your child to learn reading skills. **\$25 ea.**

Specials good through July 31, 1989

Now Toll-Free In Canada
1-800-344-7753

Monday thru Friday
9 a.m. - 9 p.m.
(Eastern Time)

Saturday
9 a.m. - 6 p.m.
(Eastern Time)

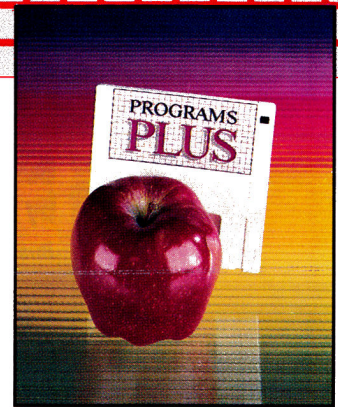

ACCESSORIES

| | | | |
|--|---------------------|---|------|
| Apple Computer Apple Mouse IIe | 125. | AntiGlare Filter IIgs | 39. |
| Apple Mouse IIc | 85. | System Saver (Platinum or Beige) | 69. |
| Applied Engineering TimeMaster II H.O. | 79. | System Saver (IIgs) | 75. |
| Sonic Blaster (IIgs) | 109. | New Turbo Mouse (Reg. or ADB) | 119. |
| IBM Style Keyboard | 119. | Kraft Universal 3 Button Joystick (IIe or IIc) | 34. |
| Audio Animator (IIgs) | 185. | Koala Technologies | |
| Big Red Computer Labels, Labels | 289. | Koala Pad Plus w/Graphics Exhibitor | 84. |
| CH Products Hayes Flight Stick | 52. | Kurta IS ADB Tablet w/stylus (IIgs) | 299. |
| Hayes Mach II Joystick | 29. | Lynx Computer Turbo Trackball (IIe or IIgs) | 65. |
| Hayes Mach III Joystick | 36. | MDIdeas Digitizer Professional (IIgs) | 139. |
| Hayes Mach IV Plus Quad or ADB | 65. | The Conservor (IIgs Switched | |
| Mirage Quad or ADB | | Surge Suppressor w/Fan) | 99. |
| (Turns joystick into mouse) | 39. | SuperSonic (Stereo Card for IIgs) | 49. |
| Cutting Edge | | SuperSonic Digitizer (IIgs) | 49. |
| EADB-105 Extended Keyboard | | Mouse Systems A+ Mouse (IIc) | 65. |
| w/Macromate (IIgs) | Special 149. | A+ ADB Mouse (IIgs) | 85. |
| Digital Vision Computer Eyes (IIe or IIc) | 109. | MousTrak MousePad 7"x9" Size | 8. |
| Computer Eyes (IIgs) | 209. | MousePad 9"x11" Size | 9. |
| Ergotron Mouse Cleaner 360° (IIgs) | 15. | MousePad L/F (Low Friction) | 9. |
| Epyx Epyx 500XJ Joystick | 27. | Passport Designs | |
| Kaimar | | MIDI Interface w/Drum Sync (AP & IIgs) | 89. |
| Teakwood Rolltop Disk Case (Holds 50) | 18. | MIDI Interface w/Tape & Drum | |
| Kensington Mouse Pocket (Reg. or ADB) | 8. | Sync (AP & IIgs) | 135. |
| Mouseway (Mousepad) | 8. | Ribbons | |
| Apple IIe, IIc or IIgs Dust Cover | | Available colors: black, blue, brown, green, | |
| or Imagewriter I or II Cover | 9. | orange, purple, red, yellow, silver or gold | |
| Apple Security System | 34. | ImageWriter Ribbon-Color | 4. |
| Printer Muffler 80 | 43. | ImageWriter Ribbon-Black six pack | 20. |
| Printer Muffler 132 | 58. | ImageWriter II - 4 Color Ribbon | 9. |
| Printer Muffler Stand 80 or 132 | 24. | ImageWriter Rainbow Pk. (6 Colors) | 20. |



Dungeon Master by FTL

Dungeon Master puts you inside the most detailed dungeon ever created in software. Every twist and turn, every nook and every corner looks real. Everything moves and works. Pickup objects with the mouse. Choose your comrades for this adventure carefully, because you'll need strong fighters and powerful wizards to survive. Requires an Apple IIgs and 1 Meg of memory. **\$29.**

BLANK MEDIA

| | | | |
|--|-----|--|-----|
| 3 1/2" Blank Diskettes | | Fuji 3.5" DS/DD (box of 10) | 19. |
| BASF 3 1/2" DS/DD (box of 10) | 17. | Maxell 3.5" DS/DD (box of 10) | 20. |
| Bulk (Sony) 3 1/2" DS/DD (box of 10) | 17. | Verbatim DS/DD (box of 10) | 19. |
| Centech 3 1/2" DS/DD Color Disks (box of 10) | 19. | 3M 3.5" DS/DD (box of 10) | 20. |
| Sony 3.5" DS/DD (box of 10) | 18. | C. Itoh 3.5" DS/DD Color Disks (box of 10) | 25. |

PRINTERS

| | | | |
|---|------|-------------------------------|------|
| Brother M-1109AP (ImageWriter Comp.) | 249. | Seikosha | |
| Panasonic | | Seikosha SP 1000 | |
| KXP-11801/M2 (192 cps) NLQ Mode | 199. | (Imagewriter Compatible) | 235. |
| KXP-11911/M2 (240 cps) NLQ Mode | 269. | Video Technology | |
| KXP-10921 (240 cps) NLQ Mode | 349. | Laser 190A w/Serial Interface | 239. |



TimeOut Graph by Beagle Bros

TimeOut Graph is a powerful graph generator that works right inside AppleWorks. Just choose the type you want and your graph appears instantly - all ready to print - with titles, subtitles, legends, borders and more. **TimeOut Paint**, the FREE drawing program included with Graph, allows you to customize your graphs even more. **\$55.**

HyperStudio by Roger Wagner

HyperStudio brings the newest computer revolution to IIgs owners! **HyperStudio** combines Super Hi-Res graphics (from popular paint programs or built-in paint tools), text from AppleWorks, or built-in editor, and digitized sound files from your own hardware or the included hardware, all in one integrated environment. Includes sound digitizing software, digitizer card, microphone and speaker. Create applications from interactive lessons to adventure stories, and more! **\$85.**



MODEMS

| | | | |
|---|------|---|------|
| Anchor Automation 1200E | 119. | Practical Peripherals | |
| 2400E | 159. | Practical Modem 1200 SA Mini | 79. |
| Applied Engineering | | Practical Modem 2400 SA | 181. |
| DataLink Modem 1200B | | Prometheus Pro Modem 2400 (External) | 255. |
| (Int II+, IIe or IIgs) | 139. | Pro Modem 2400G (Non Expandable) | 179. |
| DataLink Modem 2400B | | Pro Modem 2400A (Single Card) | 139. |
| (Int II+, IIe or IIgs) | 185. | Pro Modem 1200A (Single Card) | 119. |
| EPIC | | Supra Corporation | |
| Epic 2400 Classic II Internal w/Proterm | 189. | Supra Modem 2400 (Hayes Compatible) | 149. |
| Epic 2400 Mini Modem Ext. w/Proterm | 189. | U.S. Robotics U.S. Robotics Courier 1200 | 199. |
| Hayes Hayes 1200 Baud Smartmodem | 299. | U.S. Robotics Courier 2400 | 335. |
| Hayes 2400 Baud Smartmodem | 449. | U.S. Robotics Courier 2400E | 379. |
| MDIdeas CommLink 2400 | 189. | U.S. Robotics Courier HST 9600 | 689. |

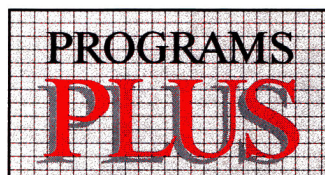

FAX: 203/381-9043
Inquiries: 203/378-3662
Canada: 1/800/344-7753
75 RESEARCH DRIVE
STRATFORD, CT 06497
1/800/832-3201

AT A GLANCE

Music Shapes 1.0 (June 1989, p. 40, by Sharon Webb), Music Systems for Learning, 311 East 38th St., Suite 20C, New York, NY 10016, (212) 661-6096, \$175

Rating: ◆

According to some educators, a child's first introduction to music should be ear training, not note reading. This is the direction Music Shapes takes. Unfortunately, students may have trouble with Music Shapes' primitive, user-hostile interface.

The program offers no music sample, and the familiar Apple IIgs interface is nowhere in sight. Instead, you see a black-and-white screen with eight cryptic labels—Pitch, Time, Sound, Save, Lifts, Flips, Shelves, and Quit.

You manipulate the notes—represented by purple squares—up and down the column to change the pitch. This is a by-guess-and-by-gosh affair, because the column isn't calibrated in any way.

Music Writer 1.3 (June 1989, p. 40, by Sharon Webb), Pygraphics, P.O. Box 639, Grapevine, TX 76051, (800) 222-7536; Level I \$119, Level II \$295, Level III \$595

Rating: ◆ ◆ ◆ ◆

Imagine a word processor that not only lets you enter a document from the keyboard, but also dictate your letter and hear it read back in a pleasant voice. That, in effect, is what Music Writer 1.3 does for music.

Level I lets students enter up to three staves of music. While it won't do away with the need for a teacher, it will go a long way toward helping the would-be musician understand music notation. For the professional composer, Level III offers 32 staves for complete orchestral scoring. Level II fits right in the middle and allows six staves—ideal for school groups, small ensembles, or church choirs. All three levels provide full-featured music-writing commands.

You can enter music from the computer keyboard with a mouse, from a

Continued

CROSS-WORKS 1.3

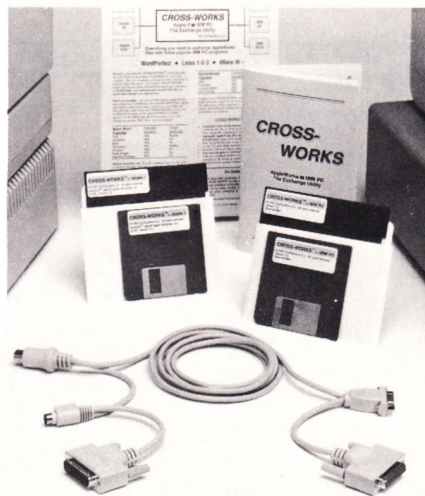

SOFTSPOKEN,
P.O. Box 97623, Raleigh, NC 27624,
(919) 878-7725

File-conversion utility; 128K Apple IIe with Super Serial Card, IIc, IIgs, or Laser 128, and IBM-PC, XT, AT, PS/2, or true compatible with serial interface; external or internal Hayes-compatible 1200-baud modems optional; \$79.95

Rating: ◆ ◆ ◆ ◆

If you're searching for a way to share word-processor documents, spreadsheets, databases, and other files between your Apple II and IBM PC or PC clone, look no further. SoftSpoken's Cross-Works carries the biggest stick in the file-translation/transportation business.

Cross-Works is a comprehensive package—including communications hardware and support software to link your Apple II directly or via modem to just about any MS-DOS-compatible microcomputer. It also provides the widest selection of translators available for no-fuss conversion of data files.

Sharing data files between an Apple II and an MS-DOS computer encounters at least two barriers. First, the way data are actually arranged and stored on disk by various programs differs widely. That's true even for applications that operate on the same computer.

The simplest translations convert a file to some format considered standard by the industry, a format most major applications can read—such as a text (ASCII) or DIF (data-interchange format) data file. Many details get lost during translation into a generic format.

The second barrier to shared files has to do with the computers themselves. Without special hardware and software, files saved on disk

with an MS-DOS computer can't be used on an Apple II or, for that matter, any other incompatible machine. You must establish a communications channel first.

Modems and direct serial cabling with support software are the most common ways to transmit information. However, you have to invest considerable time and money to purchase the equipment, set it up, and learn how to establish communications and transport files between two computers with modems. You could also spend countless hours inhaling rosin smoke as you try to make the right solder connections for a serial cable between two machines. Who needs the hassle? Are translating and transporting files worth the cost and inconvenience?

The Cross-Works package contains excellent documentation, software, and cabling for one-step translation and transportation of files between Apple II and IBM PC or compatible (here called *PC*) computers. The cable provides for direct connection between the machines. On one end, it has three plugs for direct connection to any Apple II via the built-in modem or serial port (port 2) on an Apple IIc, IIc Plus, or IIgs, or an Apple Super Serial card (or equivalent) installed in slot 2 of an Apple IIe.

One 9-pin and one 25-pin receptacle at the other end of the 6-foot cable connect to the standard serial port configured as COM1: (the preferred port for transporting files) or COM2: in the PC. Because the serial communications conform to RS-232 standards, the cable can be extended up to 50 feet.

If you need longer connections—from your office to home, for example—Cross-Works can operate with a variety of Hayes-compatible 300–2400-baud (1200-baud default) modems. The cabled connection operates at the much faster speed of 19,200 baud and doesn't cost you phone tolls.

Two 5¼- and two 3½-inch disks contain the Apple and PC versions of the Cross-Works programs, respectively. You can use the Apple disk to start up the machine. You'll need a copy of MS-DOS or PC-DOS, version 2.0 or later, to start up the PC.

Cross-Works software works like AppleWorks—using overlay menus, arrow keys to highlight, and the return key to select options. The main-menu selections for both machines include send and receive files, select target drive, communications activities, file maintenance (delete, rename, and so on), and quit. ▶

THEY'VE GOT THE PRESIDENT. YOU'VE GOT... BAD DUDES.

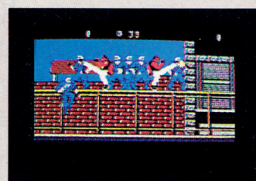
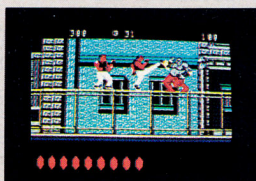
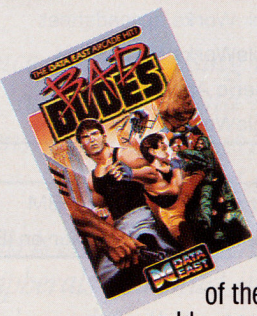

Striker and Blade. The Bad Dudes. Facing some of the nastiest ninjas in the known world—accompanied by a gang of fire-spitting thugs and their cohorts, mad dogs who are intent on serious crime. This crowd of malcontents has somehow gotten its ugly mitts on the president of the United States. And what they plan to do with him isn't pretty.

What Striker and Blade have to do isn't any picnic either. But someone's got to do it, right? What better time for you to start dishing out the *BAD DUDES'* own version of the criminal justice system? The action is top-notch. The graphics, phenomenal.

BAD DUDES from Data East. Mr. President, help is on the way.

DATA EAST

Data East USA Inc., 470 Needles Drive, San Jose, CA 95112 (408) 286-7074

Screens shown are from the IBM version. Other computer versions may vary.

© Data East USA, Inc. Bad Dudes is a registered trademark of Data East USA, Inc.

Circle 268 on Reader Service Card.

AT A GLANCE

Continued

synthesizer keyboard through a MIDI (musical-instrument digital interface) device one note at a time, or from a synthesizer played in real time.

Cartooners (June 1989, p. 106, by James Trunzo), Electronic Arts, 1820 Gateway Drive, San Mateo, CA 94404, (415) 571-7171, \$59.95

Rating: ◆ ◆ ◆ ◆

Cartooners lets children produce their own animation so easily that the creative process isn't stunted by the mechanics of the program. Using mouse commands, seven pull-down menus, and a nine-function command line, Cartooners sets new standards for simplicity and ease of use.

In as little as five steps, your child can compose animated tales to rival the Saturday-morning funnies. Select a scene, choose your characters, assign them an action, create dialogue balloons, add music and sound effects—and your little director is ready to premier his or her first cartooning effort.

MasterTracks Jr. (June 1989, p. 110, by Jerry Stoddard), Passport Designs, 625 Miramontes Street, Suite 103, Half Moon Bay, CA 94019, (415) 726-0280, \$149.95

Rating: ◆ ◆ ◆

Passport's MasterTracks Jr. is the first professional-level music-sequencer package designed for the Apple IIgs. Work screens resemble the controls of a multitrack tape recorder, with record, play, fast-forward, rewind, and pause buttons you activate with the mouse. The manual is well-written and easy to understand. Following the Quickstart Tutorial, you'll be able to begin sequencing within half an hour.

The software provides 64 tracks for recording data.

It's been a long wait for a truly useful music sequencer for the GS. MasterTracks Jr. covers all the essentials. It's easy to learn and fun to use.

In addition, because you perform all file translations on the PC side, its main menu has options for alternative formats.

In a typical session, you'll boot Cross-Works on each machine. If you're using the direct cable connection, communication is established automatically. If you're using modems, you must decide beforehand which machine is the caller and which the answerer. Then set up the appropriate modem protocol from the communications-activities option on the main menu and establish the phone connection.

Sending and translating files are automatic and involve merely tagging the source files from a listed catalog, then sending them. The received and translated files are labeled automatically with the correct file types and suffixes.

The accompanying **Table**, taken from the Cross-Works *User Manual*, lists current translation formats. Cross-Works software is designed for the most popular applications for both machines—such as translation of AppleWorks documents to and from Lotus 1-2-3, dBase III Plus, and WordPerfect. Although translations are rarely perfect, Cross-Works comes as close as you're going to get.

formats (such as ASCII files) and can assign a specified file type to the transported file or maintain the original file's format.

The latter option is most useful because translation takes time and is normally performed before (if PC to Apple) or just after (Apple to PC) transportation. If your connection is via modem, that extra time used for translation can be costly. So it's best to first translate the files on the PC into an Apple format and save them for later transportation. Or, on the Apple side, transport the original files and later translate them into a PC-compatible format.

You can also use Cross-Works' translation utilities with other Apple-to-PC hardware, such as PC Transporter.

Cross-Works performed quite well in our hands using both direct- and modem-mediated transportation. The only difficult and frustrating experience involved establishing the serial port on an IBM PC—perhaps a result of our inexperience with IBM equipment, not any problem with Cross-Works. In fact, SoftSpoken provided extraordinary technical assistance.

| DEFAULT CONVERSIONS | | |
|-----------------------------|----|-------------------------------|
| AppleWorks word processor | to | WordPerfect on IBM |
| AppleWorks spreadsheet | to | Lotus 1-2-3 on IBM |
| AppleWorks database | to | dBase III, IV on IBM |
| generic Apple text | to | DOS ASCII text on IBM |
| WordPerfect on IBM | to | AppleWorks word processor |
| Lotus 1-2-3 on IBM | to | AppleWorks spreadsheet |
| dBase III, IV on IBM | to | AppleWorks database |
| DOS ASCII text file on IBM | to | generic Apple text file |
| delimited ASCII file on IBM | to | AppleWorks database |
| ALTERNATE CONVERSIONS | | |
| AppleWorks database | to | delimited ASCII file on IBM |
| AppleWorks word processor | to | generic word processor on IBM |

Table. Cross-Works translation formats.

For example, you'll lose formulas and column widths in a spreadsheet if you use a DIF file, but Cross-Works retains them.

The material in the **Table** is by no means the entire roster of possible translations and transportations using Cross-Works. The manual names more than 50 applications for which the listed translation formats are compatible. That's because most of the formats can be used by other applications. Moreover, Cross-Works allows for the transportation of alternative file

The only drawback we encountered is that Cross-Works reverts to the "default" translation and communication settings each time you start it. Saving personal preferences for communications and translations would be a significant enhancement. Any other disappointments with Cross-Works really involve our wish list—such as wishing it would translate graphics or entire programs.

William P. Kennedy, Ph.D.

inCider staff

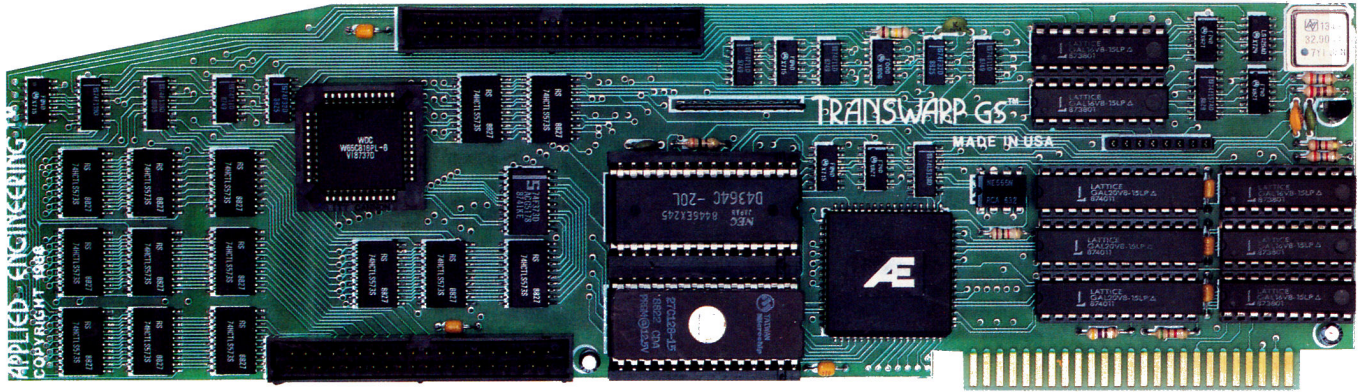

Fan mail GS

"TransWarp GS has performed flawlessly ... I've become addicted to computing at warp speed ... once you get a taste, you'll wonder how you ever got anything accomplished with your IIGS lumbering along at an unaccelerated pace ... it's an improvement you're going to appreciate every time you place your fingers on the keyboard."

— Owen Linzmayer, Technical Editor, A+

"I'm stunned ... bordering on speechless. I used to dread waiting and waiting to run GS/OS. I don't anymore. TransWarp GS breathes new life into my computer. Thanks AE, you guys are in a class by yourselves."

— Joe Kohn, *The Source*

"Once I started using the original TransWarp in my old Iie, I found I couldn't do without it, TransWarp GS promises to be equally indispensable."

— Lafe Low, Review Editor, *Incider*

"This is the card you want. Sell whatever secondary peripherals you must in order to get a TransWarp GS plugged in."

— Joe Abernathy, Houston, TX

"Together with my RamKeeper, you have given me a color Mac at one-third the price. Thanks."

— Richard Artz, Ft. Collins, CO

"I have conducted some recent tests which indicate that the "little" IIGS (with TransWarp GS) outperforms the MacSE. Your engineering department should take a bow."

— George Dombrowski, Jr., Chicago, IL

"TransWarp GS will be the best \$400 you ever spent."

— Dan Muse, Editor in Chief, *Incider*

"WOW WOW WOW! I am completely blown away with how fast it goes. Unbelievable!"

— Dean Esmay, *A2-Central*

"TransWarp GS is by far the best money I've spent on my GS since purchasing my DataLink. Hats off to everyone at AE for another great product!"

— Greg Dacosta, *GENie*

TransWarp GS is rapidly changing the way people use the Apple IIGS. Join the thousands of TransWarp GS owners who've discovered computing at Warp Speed. For more than nine years, Applied Engineering has led the way with proven, reliable products for the Apple II line. We plan to keep it that way. Thanks for the vote of confidence, folks.

TransWarp GS Accelerator \$399

Order today!

To order or for more information on TransWarp GS, see your dealer or call (214) 241-6060 today, 9 am to 11 pm, 7 days. Or send check or money order to Applied Engineering. MasterCard, VISA and C.O.D. welcome. Texas residents add 7% sales tax. Add \$10 outside U.S.A.

AE APPLIED ENGINEERING®

The Apple enhancement experts.

A Division of AE Research Corporation.

(214) 241-6060

P.O. Box 5100, Carrollton, TX 75011

Prices subject to change without notice. Brand and product names are registered trademarks of the respective holders.

Reel-World

By Lou Wallace

LIKE MOST APPLE USERS, you've progressed far from the days when text and a few simple graphics were enough for your letters, manuscripts, reports, and other documents. Today you want to bring more of the "real world" into your work. One obvious source of realism and variety is computer-graphics video. From TVs and videocassette recorders (VCRs) to the personal camcorder, the modern home is full of hi-tech gadgets just waiting for the right techniques to make an easy video/computer connection.

To help you add a slice of life to your Apple II creations, several companies (including Apple itself) offer hardware

products that let your Apple II acquire and manipulate video images from a variety of sources. In some cases, you can use the image with graphics software, such as a painting, drawing, or desktop-publishing program.

In this article we'll take a look at four products, evaluate their effectiveness, and discuss possible uses for each. Three of the software/hardware systems are video *digitizers*—devices that convert analog (nondigital) data, such as sound or video images, to a form the computer understands, numeric (digital) data. Once you've reduced the information to numbers, your computer can use it. In the case of video information, that means you can display and manipulate the resulting pictures.

While the three digitizers discussed here share some common ground—the ability to capture and display

images on the Apple II—each takes a different approach. Your needs and equipment will determine the one that's best for you. Choose the right product and you'll open new doors in personal creativity and productivity; select the wrong one and you'll probably end up with more headaches than solutions.

The fourth device isn't a digitizer at all. It's Apple's new Video Overlay Card, which lets you mix computer-generated graphics and actual video signals from almost any source (including TV, VCR, laser disc, and camcorder), then send this new signal back to yet another video device for display, recording, or even broadcast by a television station.

ALL EYES ON THE GS

Our first stop is Digital Visions' **Color ComputerEyes**, the company's latest video-digitizer board; it's strictly a GS product. (For a look at ComputerEyes for the Apple IIe see "Digitize to the Max," July 1987, p. 40; a review of Color ComputerEyes appears in July 1988, p. 33.)

Color ComputerEyes operates with any GS with at least 512K of RAM and a 3½-inch floppy-disk drive. It works with any monitor, but you'll get a better image with an RGB (red-green-blue) model than you will with a composite monitor. (A composite monitor gives you the option of viewing the incoming video signal directly, however, simplifying actions such as aiming the camera or fine-tuning the focus.)

One of the most important things to know about Color ComputerEyes is that it's *not* a real-time video digitizer—it can't grab a video frame instantly and convert it to a computer image. If you're looking for a "real-time frame grabber," ComputerEyes isn't for you. Instead it uses a technique called *slow scanning*; processing the incoming video signal takes from 6 to 12 seconds. It's imperative therefore that the source image be as motionless as possible to avoid blurring.

Digitizing from a photograph or projected slide works best, but if your VCR has a good-quality freeze-frame or ►

Digitizers, scanners, and genlock technology are the stars of this show—Apple II hardware devices that let you merge graphics and video input for realistic illustrations, presentations, and home entertainment.

I Images





Color photo digitized with Color ComputerEyes, black-and-white 320 mode, KodaVision 2400 color Camcorder.



Color ComputerEyes' black-and-white 640 mode, KodaVision 2400 color Camcorder.



Color ComputerEyes' Color 320 Super mode (320 by 200 pixels) with 16 hues on screen.

pause option ComputerEyes should work just fine. If you want to take an image from your favorite television show, it's best to record it on your VCR first, then pause at the scene you want and digitize from the tape.

ComputerEyes installs in any available GS slot; the process is fairly simple and straightforward. Just insert the card, run three small RCA-style cables through one of the rear-panel openings out the back of the computer, replace the cover, and you're ready to go.

Supplied with the hardware is a disk containing the ComputerEyes software, an easy-to-use, menu-driven program. Although you can use the mouse to make your selections, the menus are actually easier to use via keyboard; you select options by pressing a number followed by the return key.

The main menu consists of seven options, which let you capture or view an image, adjust the colors or change your default settings, modify a previously captured image, and perform a variety of disk functions, such as saving or loading pictures.

Capturing images is of course the most important part of the whole package, and ComputerEyes includes sev-

eral different formats you can use to achieve this. One of the more important is Color 320 Super, which uses the IIGS' 320-by-200-pixel mode with 16 colors (selected automatically from the palette of 4096) to acquire and display the incoming video signal.

The quality of the resulting pictures can vary a great deal, but many of the factors that influence the final outcome are completely under your control. For example, your video source of course plays a major role in how your picture will look. The better the quality of the incoming signal, the better the picture you can expect. Naturally the opposite is true as well—use a poor-quality source and the result will be poor.

I tried two cameras with ComputerEyes. For color digitizing I used the KodaVision 2400 Camcorder; for black-and-white, Panasonic's model WV1410 closed-circuit camera. The Panasonic generated a much higher-resolution image than the color camcorder; it's preferable for black-and-white work. The color camera in black-and-white mode still produced very good results, though.

Lighting's an important factor when using a video camera. If you try to digitize with insufficient lighting, your picture will be dark and poorly defined. For color images, the hues of the subject and background can make a difference. If the source contains several different colors, the software will do its best to approximate them, with varying degrees of success. If the number of colors is more limited you'll get a truer representation in the final image.

Because the GS is an excellent color-graphics machine, you might expect that color images would be the area in which Color ComputerEyes excels. Surprisingly, that's not the case. Although it does digitize in color, the results aren't quite as good as I'd hoped; they're significantly less sharp than the black-and-white images it produces. Nevertheless, a little touching up with your favorite painting program will make them quite respectable. Also, it's important to remember that ComputerEyes is the only available color digitizer for the GS.

Black-and-White Super is another 320-by-200 digitizing mode. It isn't actually black-and-white; instead it uses 16 shades of grey to make up the image. The pictures captured with this mode are good and sharp, especially if you intend to produce hardcopy on a black-and-white printer anyway, as you would if you were using a desktop-publishing program. I found that I preferred this format to all others because of the high quality of the output. (One of the reasons ComputerEyes is so good at black-and-white images is that when digitizing in this mode it turns off the board's color decoder, eliminating signal noise present with the color information.)

ComputerEyes' 640-by-200 Super mode is still another black-and-white option. It uses only four grey shades to generate its images; although it does have twice the horizontal resolution, its color resolution is very limited. This mode seems to be most useful for digitizing line art for use with drawing or desktop-publishing software.

Once you capture an image, you can edit it further in a number of ways. You can adjust color, brightness, contrast, and number of colors used in the separation; you can even convert it to other display modes, all without rescanning the original. This lets you quickly find what parameters work best with a given image.

But you can modify your picture even more radically. With Color ComputerEyes, you can quickly convert pictures to a variety of other display formats, including standard hi-res, double hi-res, or even Print Shop graphics. If that isn't enough, once you have the image you want, you can alter it from ComputerEyes' Modify menu using



options such as mirror, invert, and shrink.

Once you have a picture just the way you want it, you can save it to disk in any of a number of formats, including standard hi-res, Dazzle Draw's double hi-res, or Apple Preferred (used by PaintWorks, DeluxePaint, and others).

If you want to use digitized video images in your work, Color ComputerEyes' rich array of display formats makes it worth considering. It's an all-around good product.

YOU'LL LOVE THE THUNDER

ThunderScan, from Thunderware, is a black-and-white scanner/digitizer that works with the Apple IIe, IIc, IIc Plus, or IIGS (reviewed in January 1988, p. 26). This powerful product is unique because it doesn't use any standard video equipment as the source; instead it transforms your ImageWriter printer into a high-resolution optical scanner.

Installing ThunderScan is a snap, partially because it comes with an excellent manual with step-by-step instructions and lots of photographs, but mostly because it really is that easy. All you need do is remove your printer-ribbon cartridge and install the scanner module as you would a printer cartridge. Connect a cable from the scanner to either the game or the mouse port (depending on the Apple model you have) and you're ready to go. Of the three digitizers tested, ThunderScan is absolutely the simplest to install.

To scan or digitize an image, the original has to be in a form you can insert into your printer as you would a sheet of paper. Most photographs will work, although I found some were too thick to properly feed and others were so slick and glossy they slipped. In both cases I photocopied them and used the reproductions instead, with acceptable results. Newsprint worked very well, and I was able to generate a fair collection of clip art from newspaper ads. Even a page from a child's coloring book worked, giving me an image I could use as clip art (and one my kids loved to color with PaintWorks Plus).

ThunderScan's software is menu-driven, and easy to learn to use. The manual is outstanding, with clear, concise instructions and ample illustrations.

Once you've inserted the original into the printer, select New Scan from the menu. The program presents you with the Scan Select screen, an important part of the program, because that's where you select the area of your original to scan and indicate the resolution at which the hardware will generate the scanned image (measured in dots per inch).

ThunderScan can digitize from the relatively coarse level of about 40 dpi to an impressive 300 dpi—the same as a laser printer. Because of its ability to selectively scan any section of an image at high resolution, you can digitize an area as small as a square inch and make it fill your Apple's entire screen.

You can also select the format into which you want to

digitize the image. ThunderScan supports just about all possible Apple II graphics modes, including the hi-res and double hi-res available to all Apple IIs, and the super-res and ultra-res of the GS. You can combine most of these formats with one or more modes (half-tone, line art, or color), giving you a rich variety of screen possibilities for your final image.

Depending on the size of your original and the settings you've selected, scanning can take anywhere from one to ten minutes, making it the most time-consuming of the digitizers examined. Luckily, once you've scanned the original, you don't have to rescan just to see how it would look in another display format. Because the scanned data remain in memory, you can just select a display option, change the mode or format, and generate it quickly on screen.

On the GS I used the super-res option for the most part, resulting in an image made from 16 shades of grey. The picture was good, nearly as good as you could achieve with ComputerEyes and a color camera in black-and-white mode. And even though ThunderScan doesn't work in color, you can alter its built-in palette to generate false-color images on screen that approximate the original. Other options let you fine-tune the brightness and contrast of your digitized image.

You can save data in several formats. The first is ThunderScan, which actually saves the huge amount of information the scanner generates. Once saved, you can reload your data anytime and use them to re-create the digitized image your computer will display. Or you can save the displayed portion of the screen in a format usable by a variety of Apple programs, including DeluxePaint, PaintWorks, MousePaint, or Dazzle Draw. ►



Black-and-white photo digitized with Color ComputerEyes and KodaVision 2400 color Camcorder.



Same photo digitized with Panasonic WV1410 closed-circuit black-and-white camera, with better-looking results.

PRODUCT INFORMATION

Apple II Video Overlay Card

Apple Computer
20525 Mariani Avenue
Cupertino, CA 95014
(408) 996-1010
\$549

Color ComputerEyes

Digital Vision
66 Eastern Avenue
Dedham, MA 02026
(617) 329-5400
\$249.95

ImageWorks II

Redshift Ltd.
P.O. Box 4335
Mountain View, CA 94040
(415) 322-7373
\$350

ThunderScan

Thunderware
21 Orinda Way
Orinda, CA 94563
(415) 254-6581
\$219

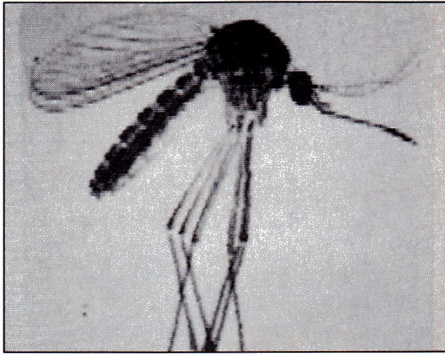

Scanned and digitized image created with ThunderScan, from a photo in a biological-products catalogue.

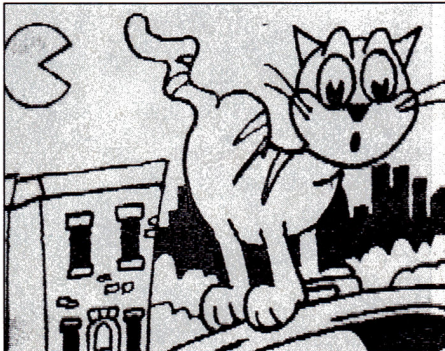

ThunderScan offers high-quality grey-scale and black-and-white digitization; here, image taken from a coloring book.

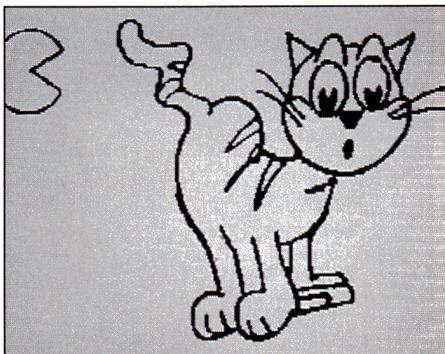

Same image loaded into PaintWorks program and edited for on-screen colorization.

ThunderScan is another excellent package for the Apple II. It can generate graphics for use in painting or animation programs as well as desktop-publishing programs. It has some limitations, such as digitizing only what you can send through the printer, and it's not a true color digitizer. Nevertheless, it offers high-quality grey-scale or black-and-white images well suited for professional use as clip art or illustrations. And because it doesn't require an expensive camcorder—just an ImageWriter, which many Apple owners already have—it's an excellent choice if you're on a budget or don't want to fool around with a camera. It's so easy to install it will appeal to you even if you're not technically oriented.

TURNING PROFESSIONAL

The third digitizer we'll examine is the **ImageWorks II** card from Redshift Limited. It's a professional-level digitizer; it offers *real-time frame grabbing*—it can capture an image in about $\frac{1}{60}$ of a second, quick enough to grab fast-moving images without blurring. It also has the distinction of offering a screen resolution of 256 by 256 pixels with a palette of 256 shades of grey on screen at one time, even on the Apple IIe.

ImageWorks can generate this large number of on-screen shades because it bypasses the Apple II's video hardware and generates its own composite image, overlaying it on the Apple's regular image.

This technique incurs some severe disadvantages, though. For example, if you're using ImageWorks with a GS and an RGB monitor, you'll see on-screen menus, but you *won't* be able to see any video output from the digitizer. ImageWorks requires a composite monitor for that; to use it I hooked up two monitors to my GS—the standard RGB and a regular composite monitor.

Installation of the ImageWorks card (in slot 7) isn't difficult, but it's hampered by a poor manual, which is

really only a few photocopied pages of technical information. (The documentation states it's both preliminary and incomplete.)

Once you've installed it and hooked it to the proper monitor, you can boot the software supplied with the card. The program is menu driven and is written in BASIC with calls to the specialized machine-language code that drives the ImageWorks card. Because it's BASIC, it should be easy for you to modify or study if you have programming experience.

Using a video camera, VCR, or other NTSC (National Television Standard Code) video source connected to your computer's video-input jack, just press the letter C (for *capture*) to digitize an image.

The picture appears instantly on the composite monitor. If this image isn't what you want, you can try again, because the time required to capture it is insignificant.

ImageWorks' digitized pictures are by far the best of those produced with the three digitizers tested here. They look like frozen images from an extremely sharp black-and-white TV.

When you have the picture you want, you can save it to disk, or you can choose to modify it in a number of ways—mirror it, rotate it, dim it, filter it, reverse it, or even convert it to a pure black-and-white binary image.

Once you've saved the image, though, your options are limited. Because ImageWorks II uses its own display system, you can't use pictures captured with any other software. That is, you can't load a saved image into a painting or desktop-publishing program. And Redshift doesn't supply utilities to transform these very high-quality images into a format you can use outside the ImageWorks II card.

What can you use ImageWorks pictures for? The product appears to be aimed at technical users who need to generate digital pictures for image processing and analysis and can write custom software to use them. It's well suited for laboratory use; some technically oriented hobbyists will just love it. But if you're an average user, this one isn't for you. That's a shame, because the images are so good many people would love to be able to use ImageWorks II.

ROLL 'EM

The latest in Apple video technology is the **Apple II Video Overlay Card** from Apple Computer. This device, also called a *genlock*, lets you mix computer graphics with an external video source to create a new signal you can record or display.

Television stations use this technique all the time, placing text on top of video images for special effects. With the Apple II Video Overlay card, you can do the same type of thing.

It's called an *overlay* card because the graphics data from your Apple are superimposed, or overlaid, on the video signal. Because it works with any computer image, you can use almost any program to generate the computer data.

To install the overlay card insert it into slot 3 on the GS; it can go into any slot on the Apple IIe. Mount a couple of connectors on the rear-panel openings of the Apple, and hook up the cables from the connectors to the card. The manual describes the process accurately and contains plenty of illustrations.

After you've installed the card, you must connect your monitor to it. (It works with either composite or RGB.) The video source connects to the video-in plug, via an RCA phono plug, to the new video-in plug, and you run the signal out to another video source such as a VCR (for recording) or TV (for display).

The overlay card works by letting one or more hues on the computer screen act as transparent colors, so that when the two signals are mixed the video image will "show through" the transparent colors. Computer colors that aren't transparent will appear to be on top of the combined image, thus creating your special effect.

The software key to all this is a new desk accessory (NDA) for the GS and a standalone application program for the Apple IIe called VideoMix. If you're using an Apple IIe, run VideoMix before any application you want to use to generate computer graphics. On the GS, you must install VideoMix on your system disk (using supplied software), where it will appear as an option on your Apple desktop.

When you run VideoMix, the software presents a palette showing available colors. You can select one of them to be your transparent color, or you can pick the color you want from the computer screen. This transparent color is called the *key color*.

You don't have to make just one color transparent—you can also set a range. For even more unusual effects you can make some colors translucent, so that they remain visible, but the video image shows through. This generates an effect that looks something like colored glass.

How good are the results produced with Apple's Video Overlay card? According to the company, the quality of the final video output depends on the quality of what you start with. Judging from my experience with the product, even home video equipment seemed to work well. I wouldn't expect serious broadcast or video professionals to drop their current equipment in favor of the Apple II Video Overlay Card, though.

So what can you use it for? The product is well suited to a variety of home, school, and semiprofessional applications. The most common use will probably be titling for home videos. For example, using two VCRs (one as the video source and the other to record the final results), the Apple IIGS, the Overlay Card, and PaintWorks Plus, I added colorful titles and art to video recordings of family events. Names, places, and dates appear in large colorful displays; if you're feeling particularly mischievous you can add funny messages in appropriate places, too.

In a more serious vein, schools that use video cameras

for class or instructional purposes will find the Overlay Card a valuable addition to their Apple II repertoire. Adding titles to the class play or creating instructional tapes are obvious applications.

Small businesses can use it to create self-running videos for storefront displays. Ambitious companies can save a bundle by creating their own commercials for broadcast on local TV stations.

IT'S A WRAP

There you have it. From scanners to digitizers, from frame grabbers to genlocks, one of the top video products we've examined here will help you capture the real world. The trick in selecting the right one is to know what you want to do before you decide on the equipment.

Do you want to incorporate real-world pictures into your Apple IIGS paintings or illustrations? In that case, you'll probably want to look into Color ComputerEyes.

If you're more interested in using illustrations in an Apple desktop-publishing package and if those graphics are on paper, ThunderScan is what you're looking for.

Need high-quality images for the hospital lab? ImageWorks II is just what the doctor ordered. And if you've decided to enter the exciting world of video production, or at least experiment in it, you'll certainly need the Apple II Video Overlay Card.

Each of these products offers quality and versatility; each is aimed at a different audience, though. For home or business, before you shop, decide what you're looking for and you'll find an Apple II video product to help you achieve the effect you're after. □

LOU WALLACE IS TECHNICAL SUPERVISOR FOR *RUN* MAGAZINE (IDG COMMUNICATIONS/PETERBOROUGH). WRITE TO HIM C/O *INCIDER*, 80 ELM STREET, PETERBOROUGH, NH 03458.

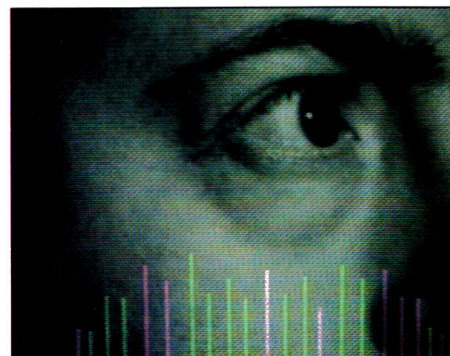

Real-time frame grabbing with ImageWorks II: Histogram shows intensity of light in each column.



Composite monitor lets you see ImageWorks menus overlaid on digitized video output.



Overlay Card mixes computer graphics and video signals; here, DeluxePaint clip art overlaid on video frame.

TEN STEPS

By CYNTHIA E. FIELD, Ph.D.

Ten easy steps help you master
AppleWorks GS' page-layout
features for news bulletins
and all your other
desktop-publishing needs.
AppleWorks GS has got it—
it's up to you to flaunt it!



AS YOU'RE CHEERING ON the boys of summer, consider this: AppleWorks GS is a lot like the Boston Red Sox. They're both major-league competitors, neither one excels in speed, and once or twice their valiant attempts result in a crash. Still, they make an all-out effort, and if you stick by them, you'll end up with a championship product.

This month let's "warm up" by designing a one-page bulletin for a hypothetical senior-citizens organization. We'll use **AppleWorks GS** (minimum requirements: 1¼-megabyte Apple IIGS and one 3½-inch drive).

Retired folks probably invented the terms "day trip" and "bus tour," so our bulletin is one you'd likely find posted on a cork board at a senior center or apartment complex.

READERS' CHOICE

Because I wanted my bulletin to be as clean, crisp, and easy to read as possible, I opted for a straightforward layout. I purposely selected familiar-looking fonts such as New York and Courier and avoided any "squint print." To underscore this less-is-more look I implemented a single illustration and used color judiciously.

Despite its simplicity, the publication (see the next page for a color rendition of the final product) contains some 20 objects. Fortunately, you can duplicate this one-page wonder (or create your own) in just ten steps.

STEP 1: THE BASIC PAGE

Launch AppleWorks GS. Select the Page Layout (PL) icon from the Open File dialog box that appears. To select the icon, just double-click on it with the mouse.

Once you've loaded the PL application, click on Fit in Window from the Options pull-down menu (or press Open apple-W). You should see a blank page like that shown in **Figure 1**.

Click on Set Guides from the Options menu. Click on radio buttons in the dialog for margins and columns: Choose 0.5-inch margins for *Left/Right* and *Top/Bottom*. Opt for *three* columns and 0.25-inch column spacing. Click on *OK* or press Return to accept these values. The resulting page complete with guides should look like **Figure 2**.

Pull down the Options menu and turn on Magnetic Guides; they "attract" objects positioned near them for greater precision than you could obtain manually.

Click on Lock Guides (Options menu) to prevent guides from being jarred accidentally. From the File menu, Save this file as Lets.Go.1.

Saving your progress frequently is good policy, especially if you're using an early release of AppleWorks GS, which may have an annoying penchant for messing up page layouts without warning.

STEP 2: TYPE THE CONTENTS

Pull down the File menu and click on Open. At the dialog, click on the Word Processing (WP) icon to open a window. Don't worry, the PL window isn't lost, just hidden behind the WP window.

Select the 9-point (Size menu) Courier (Font menu) font, and type the bulletin's body text. To keep the bulletin short and sweet, and to save room for special effects, restrict this file to about 200 words.

Begin dressing up some of this text now. Select the subheading *Boothbay Harbor, Maine*.

to BASIC DESIGN



One way to select text is to hold down the mouse button and drag across the words. A quicker way is to select a whole line of text by placing the I-beam (the WP cursor) on the line and triple-clicking. With the subheading selected, pull down the Style menu and click on UPPERCASE. Pull down the menu again and click on Underline (or press Open apple-U).

In the second paragraph, italicize the name of the musical *Singing in the Rain*: Select the play's title, pull down the Style menu, and click on Italic (or press Open apple-I).

Scroll to the top of the WP file. Click on

Spelling (Search menu) and insert the AppleWorks GS Utilities disk, which contains the program's "dictionary." Following the on-screen prompts, ignore flagged words or correct them when appropriate. When you're finished editing, save the WP file as Lets.Go.Text.

Click on the close box in the upper left-hand corner of the WP window to remove it.

STEP 3: LINK IMPORTED TEXT

Pull down the File menu and click on Import File. Select Lets.Go.Text from the appropriate disk directory by double-clicking on the filename.

After reading the file, PL changes the appearance of the cursor to a partial-page icon. Move it to column 1 and click. PL creates a text area automatically, and text flows into it. With the selection arrow, activate column 1 by clicking on it. Four "handles" appear in the corners of the text area and two "tags" appear centrally located along its upper and lower borders. Click on the lower tag.

Move the partial-page icon to column 2 and click. PL creates a second text area automatically. Click on column 2 to activate it. Click on its lower tag, move the resulting partial-page icon to column 3, and click. A third text

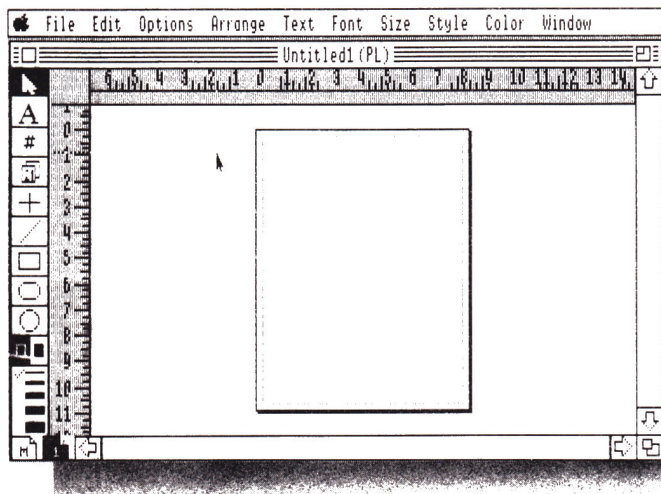

Figure 1. Screen dump of blank page.

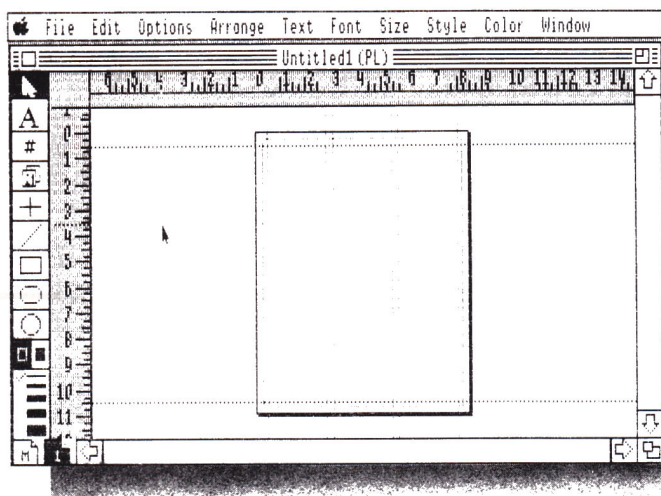

Figure 2. Page with columns and margins.

area now fills column 3. For now, don't be concerned that column 2 is filled only partially with text and column 3 is empty.

To understand what you've accomplished, select all three text areas: Click on column 1; then, while holding down the shift key, click on columns 2 and 3. All three display tags with plus signs indicating linkages: in column 1, the lower tag only; in column 2, the top and bottom tags; in column 3, the top tag only. Click outside the page to "deselect" these objects and remove their handles and tags. Save this PL file as Lets.Go.2.

With the selection arrow, click on column 1. Shrink its size by pointing to its lower right-

hand handle, pressing the mouse button, and dragging it upward. Glance at the vertical ruler to help you make the column about 6 inches high. If you've set up text links properly, shrinking column 1 will make any "squeezed out" text flow into column 2.

Shrink column 2 to about 6 inches. Some text will flow into column 3. Now shrink column 3 to about 5 inches. One by one drag each column so that its top border is positioned about 2 inches below the top margin. To drag an object such as a text column, place the selection arrow on the object, hold the mouse button down, and drag the column into position.

Switch from Fit in Window to Actual Size mode (Open apple-W or Options menu). Toggle this way as often as necessary to zoom in and out; you'll be able to see the page's details and fine-tune its text or view its overall construction. Save this file as Lets.Go.3.

STEP 4: CREATE A PULL QUOTE

In Actual Size mode, use the scroll bar to move about halfway down column 2. You'll want to insert a pull quote between paragraphs 1 and 2. Select the text tool and place the I-beam in the space between *Freeport* and the line *During your stay*. Press Return three times to make room for this special effect.

In column 1 select the part of Mary Kelly's quotation that reads *last summer's production of Singing in the Rain was superb!* Press Open apple-C to take an electronic "snapshot" of these words. AppleWorks GS stores a copy of the statement temporarily in a special area of computer memory called the *clipboard*.

Return to the pull-quote location in column 2. Position the I-beam about halfway down the empty pull-quote space and press Open apple-V to "paste" the text into place. Add the open quotation mark and the leaders (the three initial periods).

Select the pull-quote text, then enhance it with boldface (you'll find it on the Style menu) and centering (look for it on the Text menu).

Now place the I-beam after the word *of* and add a carriage return. To place the words *was* and *superb* on the same line, hit Return after the word *Rain*.

Select the horizontal/vertical line tool. (It looks like a large plus sign.) "Rubber-band" (press and drag) one horizontal line (a "rule") above and one below the pull quote. Select line thickness #2 from the line palette, and rubber-band companion rules, as shown in Figure 3. Delete any unnecessary "white space" above or below the pull quote by placing the I-beam in the blank area and pressing the delete key. Don't panic if your rules disappear. (It's temporary.) Just choose the selection arrow, and the rules will reappear.

Adjust each rule's length precisely by selecting it and dragging one of its handles. Fine-tune a rule's placement by selecting it, picking it up anywhere *except* on a handle, and dragging it into position.

In Fit in Window mode, use the horizontal/vertical line tool to rubber-band a rule of #1 thickness between columns 1 and 2 and

another identical rule between columns 2 and 3. Use Actual Size mode to adjust each rule's length and position as required. Save this file as Lets.Go.4.

STEP 5: HIGHLIGHTING WITH RECTANGLES

Select the rectangle tool, the "hollow" icon (it's the default), and line thickness #3. Pull down the Color menu and click on the light-blue color (third from the bottom). Rubber-band a hollow blue rectangle for the "Coming Events" box.

Switch to line thickness #1, and rubber-band a hollow rectangle for the "Jaunts" subtitle area. Select black from the Color menu and line thickness #2. Rubber-band a hollow rectangle for the August events box.

STEP 6: SUPERIMPOSE TEXT AREAS

With the text tool, rubber-band text areas on top of these hollow rectangles. While you're at it, rubber-band two other text areas—one for the "Let's Go!" title and another for the "Sponsored by..." area.

In Actual Size mode, place the I-beam in each text area and enter its contents. You may need to enlarge a text area to accommodate selected type sizes. Use 24-point (Size menu) bold (Style menu) New York (Font menu) for the title; 12-point bold Courier for the Subtitle; 12-point underlined New York (centered) for the "Coming Events" box; 9-point Courier for the August events area; and 12-point Courier (centered) for the "Sponsored by..." information.

Adjust the size and position of final text areas with respect to their accompanying hollow-rectangle "borders" by first selecting the text or shape object you want to edit. Drag a handle to shrink or enlarge the object. Pick up an object anywhere (except on a handle) to move it. Use the same methods to fine-tune text areas lacking graphics borders. Save this page as Lets.Go.5.

STEP 7: IMPORT CLIP ART

For our high-flying seniors, I used the hot-air-balloon graphic from the "Vehicles" file in Mediagenic's **Clip Art Gallery**. This handy art disk comes free packaged with the Apple IIGS paint program **Paintworks Plus**.

Open (File menu) AppleWorks GS' graphics (GR) application by double-clicking on the paint-palette icon that appears in the dialog.

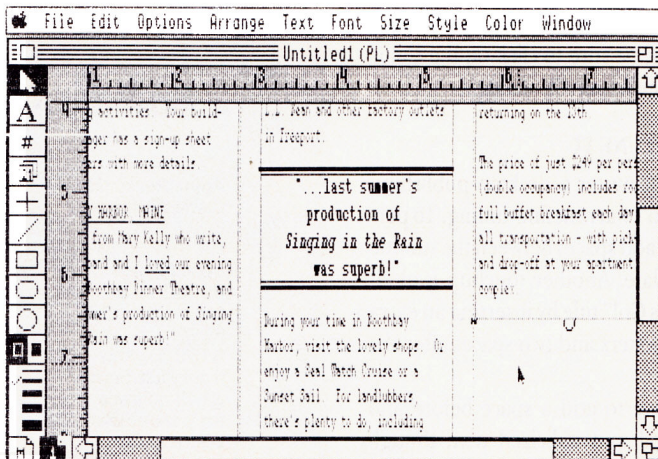

Figure 3. Screen dump of pull quote.

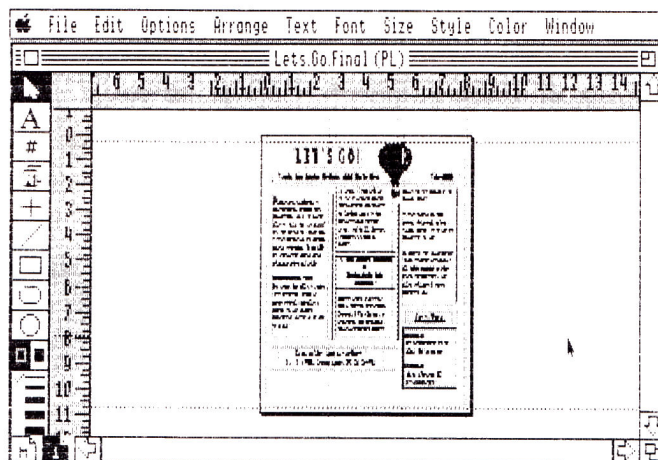

Figure 4. Screen dump of final proof.

Place your clip-art disk in a drive and select Import File (File menu). Select the desired clip-art file from the appropriate directory.

When the clip art appears on screen, choose the lasso (the second tool in the second column) from the GR tool palette. Lasso the piece of artwork you want by dragging this tool around the illustration's periphery. Press Open apple-V to take a "snapshot" of the graphic.

Put away the GR application by clicking on its close box. Choose No when AppleWorks asks whether you want to save the GR file.

In the PL window use Fit in Window mode to determine where you'd like the graphic to

appear. Press Open apple-V to drop the clip art onto the page. Drag the illustration into precise position with the mouse. Use Actual Size mode to make sure the graphic doesn't crowd any text. Save this file, which will look something like **Figure 4**, as Lets.Go.PROOF.

STEP 8: PRINT THE PROOF

Select Choose Printer (File menu) and opt for the ImageWriter.CL driver (the program's default). Select Print (File menu or Open apple-P). For optimum printout quality, choose the Better Text option from the ImageWriter.CL dialog. Place a black (or four-color) ribbon in your ImageWriter and generate a ▶

draft, or "proof," of your bulletin. If you want to print in color, be sure to click on the Color box in the ImageWriter.CL dialog.

STEP 9: FINE-TUNE IT

I've yet to encounter a desktop-publishing proof that doesn't warrant fine-tuning. To perfect this project add spaces between the subtitle and the issue date. Another touchup is elongating the "Let's Go!" title by inserting an extra space between letters and two spaces after the word *Let's*.

We'll also have to add a space before and after underlined and italicized text, though words with both types of formatting look properly spaced on screen.

For a touch of color in the lower left-hand area of the page, I decided to add pairs of blue rules (#1 line thickness) above and below the "Sponsored by..." area. I adjusted the length of the vertical rule under the hot-air balloon in the gutter between columns 2 and 3.

Finally, I selected the first letter of the first

PRODUCT INFORMATION

AppleWorks GS
 Claris Corporation
 5201 Patrick Henry Drive
 P.O. Box 58168
 Santa Clara, CA
 95052-8168
 (415) 960-1500
 \$299
 \$169 upgrade
 from MultiScribe
 \$149 upgrade
 from MultiScribe GS
 \$99 upgrade
 from AppleWorks 2.0

PaintWorks Plus
 with **Clip Art Gallery**
 Mediagenic
 3885 Bohannon Drive
 Menlo Park, CA 94025
 (415) 329-0800
 \$79.95

paragraph, enlarged it to 12-point size, and converted it to bold outline style (Style menu).

Whatever cosmetic surgery you decide to perform on your version of this project, don't forget to save the last draft as Lets.Go.Final.

STEP 10: POST IT

No single project can exploit a desktop-publishing program's complete array of features. Nor would you want to read anything that did. But creating a one-page notice like this one, and learning to work around the program's flukes, can bring you closer to mastering AppleWorks GS' colorful, integrated publishing power. □

CYNTHIA E. FIELD IS A FREE-LANCE JOURNALIST SPECIALIZING IN COMPUTER-RELATED TOPICS. SHE IS A CONTRIBUTING EDITOR AND THE AUTHOR OF FIELD TRIP, *INCIDER'S* COLUMN ON EDUCATIONAL SOFTWARE, AND PRESS ROOM, OUR COLUMN ON DESKTOP PUBLISHING. WRITE TO HER AT 60 BORDER DRIVE, WAKEFIELD, RI 02879. ENCLOSE A SELF-ADDRESSED, STAMPED ENVELOPE IF YOU'D LIKE A PERSONAL REPLY.



World of Flight

Travel the globe with the best in simulation software; Flight Simulator™ and Jet™. Discover the world with Flight Controls I and Scenery Disk supplements to our integrated flight line! Call (800) 637-4983 for our new brochure.

Flight Simulator, Jet, and Flight Controls I are trademarks of SubLOGIC Corp. IBM screens shown. Other computer versions may vary.

subLOGIC

CompuServe Now Available
at **Radio Shack**



Meet An Apple A Day.

The largest group of Apple® users in the world shares its problems and solutions online every day in CompuServe's Apple Forums. And you can join them.

Find out which Apple software lives up to its claims, how to best use AppleWorks™ and other programs, and access new graphics and sound capabilities on Apple II GS.™ Get support from Apple software authors and hardware vendors.

Want to learn more about educational software? Browse our vast library of programs. Any games fans

in the house? Visit a CompuServe Apple Forum for software and support. There's no better way to get more out of your Apple.

To join CompuServe, see your computer dealer. To order direct or for more information, call 1 800 848-8199. In Ohio and Canada, call 1 614 457-0802. If you're already a member, type GO APPLE at any ! prompt.

CompuServe®
An H&R Block Company

MULTIPLE

By RICHARD SPITZER

Break out of that boring
single-column format!
Your AppleWorks Classic
word processor has a hidden
talent—the versatility of a
desktop-publishing program that
lets you create attractive,
multicolumn reports and newsletters.



IF YOU WANT TO CAPTURE someone's attention, create a striking first impression. After all, it's not just *what* you say that matters, it's *how* you say it, too. A clean, crisp-looking document will entice your reader's eye; see what multiple columns can do for fast, easy reading and a professional-looking newsletter or brochure.

Dozens of Apple II programs let you produce multicolumn documents. The success of programs such as Publish It! proves that the appeal of feature-rich, font-filled page-layout programs isn't lost on Apple II users. But what if you use 8-bit AppleWorks (Claris Corp., \$249) and don't want to invest the money or time a desktop-publishing program demands?

Here's a pleasant surprise: In some respects, you *already* have one. First, AppleWorks' word processor can produce multicolumn formats in the spreadsheet by way of the database manager. That involves transferring your information via ASCII and DIF files, though. Not only is it cumbersome, but you end up losing AppleWorks' printing options—justification, boldface, underlining, superscripts, subscripts, and so on. You can't always achieve the effect you're after.

SINGLE FILE

There's a simpler way. If your printer lets you roll the page back and print a second or even third time on the same sheet of paper, you're all set to produce two- or three-column layouts in the AppleWorks word processor. The basic procedure is simple: Produce the document, then format it into the column widths you want. After you print a column, roll the paper back into the printer, adjust the margins, and print the next.

Begin by creating your document in standard form with one-inch margins, the easiest way to edit and check your spelling. Design breakheads (enlarged subtitles) by changing the characters-per-inch setting on AppleWorks' printer-options menu (Open apple-O, or OA-O here) from 10 to 5. After you've finished writing and editing your document, you're ready to format for columns. (Don't forget to save.)

Start by creating one long, narrow column: Set the printer options at the beginning of your document, so that the screen will show the same column width as your hardcopy. If you're producing two columns, set the left margin at 0.5 and the right one at 4.4 inches. If you want three columns of text, use 0.5 for the left margin and 5.5 inches for the right.

Now proofread your document. You may find that long words or hyphenated expressions wrap awkwardly onto the next line. If that happens, try using synonyms or change the order so that long words appear on only one line.

Breakheads prepared with printer options (fewer characters per inch to produce larger letters) may no longer fit into the narrower format. You can either rephrase them or change the character-per-inch setting from 5 to a more appropriate number.

FALL IN

Once you're satisfied with the overall appearance of your document, you're ready to format multiple columns on screen. If you want left and right margins justified for all columns, return to the beginning of the column and press OA-O. Once you've called up the printer-options screen, select JU to indicate *Justified*. Keep in mind, though, that full

COLUMN LAYOUT



justification with narrow columns may produce large spaces between words.

The basic procedure involves calculating the page breaks in your single-column document. At each page break, you'll use AppleWorks' printer options to set margins that will place that part of your document on the left, center, or right side of the paper (so that when you roll back the paper in your printer the next column of your document will appear to the right of the previous column).

There are two ways to indicate printer options. You can type them in each time you want to change the margins, but that's time-

consuming (and boring). The second method involves copying all printer options to the clipboard. Then, at each page break, copy all options from the clipboard and delete any you don't need.

This second method has two advantages: First, you're less likely to make errors; second, by storing your two menus as separate files, you can set up two- and three-column formats without having to retype the information.

Now create two new word-processor files from scratch and call them *COLUMNS 2* and *COLUMNS 3*. Bring up *COLUMNS 2*; press OA-O and duplicate these printer options:

Set a Marker: 1
New Page
Pause Here
Left Margin: 0.5 in.
Right Margin: 4.4 in.

Set a Marker: 2
New Page
Pause Here
Left Margin: 4.4 in.
Right Margin: 0.5 in.

Save the file. Now bring up *COLUMNS 3*; hit OA-O and duplicate these options: ►

Set a Marker: 1
 New Page
 Pause Here
 Left Margin: 0.5 in.
 Right Margin: 5.5 in.

Set a Marker: 2
 New Page
 Pause Here
 Left Margin: 3.0 in.
 Right Margin: 3.0 in.

Set a Marker: 3
 New Page
 Pause Here
 Left Margin: 5.5 in.
 Right Margin: 0.5 in.

Save your file. Note that "Set a Marker" has no printing function. You'll use it on screen simply to identify the printer format for column 1, 2, or 3.

DOUBLE UP

The example we'll follow here produces a two-column document, so the next step is to copy (OA-C) the file COLUMNS 2 to the clipboard. Then return to your single-column document.

The printer options at the beginning of your document should be Left Margin 0.5 inches and Right Margin 4.4 inches.

Hit OA-K to calculate the page breaks, and find "End of Page 1." If necessary, move the column to a logical break. Then press OA-C to copy the formats from the clipboard.

Because AppleWorks will print page 2 in column 2, you must delete all printer options listed between Set a Marker 1 and Set a Marker 2.

Also delete hard-carriage-return markers and any additional blank lines or they'll appear in your printed document. Save your file.

Recalculate the pages (OA-K), and copy the formats again from the clipboard at the next break.

This time delete the options for Set a Marker 2, as well as all hard-carriage-return markers. If you're installing the printer options correctly, your document's pages will alternate from left to right on screen. (Don't forget to save.)

THREE'S NO CROWD

If you're formatting for three columns, be sure the printer options at the beginning of your document are Left Margin 0.5 and Right

*"IT'S NOT JUST WHAT YOU
 SAY THAT MATTERS, IT'S
 HOW YOU SAY IT, TOO.*

MULTIPLE COLUMNS GIVE

YOU EASY-TO-READ,

PROFESSIONAL-LOOKING

DOCUMENTS. YOU WON'T

NEED A DESKTOP-

PUBLISHING PROGRAM—

YOU'VE GOT APPLEWORKS!"



Margin 5.5 inches.

Use the same procedure outlined above, but delete the printer options for the two columns that don't apply at that particular page break. Remember to delete any Return markers.

Again, if you do this correctly you'll see your document's pages print on the left side of the screen, then in the center, and finally on the right.

ROLL THE PRESSES

Adjust the paper in your printer, and note the position of the perforation relative to a fixed point. Accuracy is essential, because you'll have to roll the paper back to this point each time you print another column on the same sheet.

Begin printing your document (OA-P); the first column appears on the left side of the paper. Printing stops when the printer reaches the option *Pause Here*.

Roll the paper back and realign the perforation with the fixed point you identified. Hit the spacebar, and AppleWorks continues printing the second column in the correct location, then stops at the end.

Roll the paper back a second time if you're printing a third column. Now align the perforation and hit the spacebar to print the first column on the next sheet. Continue until you've printed your entire document.

You can add a headline to the top of any page, but do it before you calculate your page breaks. Be sure margins are set to .5 inch on each side. Type the headline with fewer characters per inch (5 in this example) and center it if you like. Insert two blank lines to separate headline from text.

MARGINAL EFFECT

If you want to add a line completely across the screen (using equal signs, pluses, minuses, or any other character) insert two more blank lines and place the printer option *Pause Here* at that point.

Adjust the paper so that the perforation is aligned according to the fixed point on the printer, then run out only the headline. Measure how far the paper has moved up from the fixed point, add that amount to the existing top margin, and insert the total as a new Top Margin printer option at the beginning of the column.

Calculate page breaks as described earlier. After AppleWorks figures the page breaks for your two- or three-column headlined page, insert the original Top Margin printer option for the remainder of the document. Roll the page back and align the perforation with the fixed point before printing the columns below the headline.

A FLAIR FOR DESIGN

After working with column formatting awhile you'll discover a number of variations you'll want to try. Add headlines on other pages; move columns so that text beginning on the first page continues on later pages; insert blank spaces for clip art and graphics you'll paste in later. Experiment with color ribbons when printing different parts of your document.

It's simple, but the procedure described here can save you time and money. To create great-looking, multicolumn documents just boot up AppleWorks—your word processor and your trusty printer are all the design tools you'll need. □

RICHARD SPITZER IS A JUNIOR-HIGH-SCHOOL SCIENCE AND PHOTOGRAPHY TEACHER AND CO-CHAIRPERSON OF HIS DISTRICT'S COMPUTER RESOURCE TEAM. HE IS THE AUTHOR OF THE APPLEWORKS TEMPLATE/MACRO PROGRAM TEST-MAKER (AVAILABLE FROM THE AUTHOR). WRITE TO HIM AT 912 KINGSLEY DRIVE, COLORADO SPRINGS, CO 80909. ENCLOSE AN SASE IF YOU'D LIKE A PERSONAL REPLY.

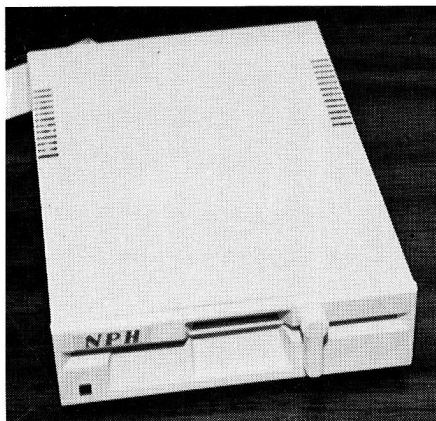

5 1/4" DISK DRIVES FOR APPLE

1 Year Warranty
Parts & Labor

Apple II, II+, IIe
Franklin Ace 1000

\$79.00

100% Compatible

Super Quiet

Apple IIc, IIc+, IIGS
Apple IIe UniDisk

\$79.00

Adjustable Speed
Control

Laser 128

Shipping & Handling \$5.50

| | | | |
|--|---|---|---|
| <p>We have the ABSOLUTE Lowest Prices on CHECKMATE PRODUCTS</p> | | <p>LASER 128 EX Three Times the Speed of a IIe Built in Memory Expansion Board</p> <p>\$445.00</p> | <p>UNIVERSAL Disk Controller Run 800K Disc Drives on your II+ and IIe \$79.00</p> |
| <p>PRO TERM \$79.95</p> | <p>MultiRam RGB IIe 0K to 1 Meg. from \$121.00</p> | <p>800K DISK DRIVE 3 1/2" for II+, IIe, MAC, LASER 128 \$179.00</p> | <p>Disk Controller Card For Apple II, II+ & IIe \$34.95</p> |
| <p>MultiRam IIe 0K to 768K from \$88.50</p> | <p>MultiRam IIc 0K to 1 Meg. from \$105.00</p> | | <p>5 Year Warranty</p> |
| <p>Memory Saver GS \$109.00</p> | <p>MultiRam GS 0K to 2 Meg. from \$117.50</p> | <p>Extended 80 Column Card With 64K For Apple IIe</p> | <p>Cooling Fan For Apple IIGS \$19.95 No Noise Interference</p> |
| <p>AI Juice Plus GS 0K to 4 Meg. from \$65.00</p> | | <p>100% Appleworks Compatible \$38.95</p> | <p>Cooling Fan For Apple II+ & IIe With Surge Suppressor . . . \$26.95</p> |
| <p>Super Expander IIe 1 Year Warranty W/Appleworks Expansion S-ware 0K to 1 Meg. from \$52.50</p> | | <p>5 Year Warranty</p> | <p>DISKETTE STORAGE W/Lock 5 1/4 Holds 70 Disks \$6.95 5 1/4 Holds 100 Disks \$8.95 5 1/4 Holds 120 Disks \$10.95 3 1/2 Holds 50 Disks \$6.95 3 1/2 Holds 100 Disks \$8.95</p> |
| <p>256K RAM Call</p> | | <p>Super Serial Card 100% Apple Compatible</p> | <p>Cables From \$9.95 IIe to Modem IIc to Modem IIe to IMG I IIc to IMG II IIe to IMG II Others Talk & Data Kits SCSI Cables</p> |
| <p>LASER 190A Printer \$225.00</p> | | <p>Graphics Printer Card w/Cable For Apple II+ & IIe</p> | |
| <p>Amber Monitor \$99.00</p> | | <p>5 Year Warranty \$44.95</p> | <p>ACCESSORIES Mouse Pad \$4.95 Disk Notcher \$4.50 Disk Clean 5 1/4 \$4.00 Disk Clean 3 1/2 \$4.00 LASER Add on's Call Mouse \$59.00</p> |
| <p>EPIC 2400 Baud Modem \$159.00</p> | | <p>II+ Owners 16K Card \$34.95 128K Card \$64.95 80 Column Card \$48.95 Plus Works \$49.00</p> | |
| <p>MINI DIN 8 Switch Box A/B \$24.95 A/B/C/D . . \$29.95</p> | <p>5 Amp Power Supply \$49.00 Apple II, II+ & IIe</p> | <p>ZIP CHIP \$149.00</p> | <p>Numeric Keypad For Apple IIe \$34.95</p> |
| <p>Replacement Keyboard For IIe \$55.00</p> | <p>MINI A/B Switch Box Serial or Parallel \$24.95</p> | <p>CPM Card for Apple II+ & IIe 5 Year Warranty \$34.95</p> | <p>RF Modulator II+ & IIe \$15.95</p> |
| | | <p>Prices subject to change without notice</p> | <p>Joystick for Apple IIe, IIc, IIc+, & IIGS With Fire Button Same as Mach III \$24.95</p> |

We Ship
2nd Day Air
Continental US Only

VISA & MASTERCARD — NO EXTRA CHARGE DEALER PRICING

Most Items +\$4.00 for Shipping - C.O.D. + \$2.75

MEMORY PLUS DISTRIBUTORS, INC.

505 South 48th Street, Suite #104

Tempe, Arizona 85281

(602) 820-8819

(602) 830-6457

FAX# (602) 968-3211

Serving Apple Users Since 1983

We carry only the
Highest Quality products for
your Apple.
That's why we are
the **LARGEST**
and
the **BEST!**

10 a.m. to 5 p.m.
M.S.T.
Mon - Fri.

University & School P.O.
Accepted

20% Restocking charge
on returned items

We Ship
2nd Day Air
Continental US Only

LOCK IT UP!

What could be worse than losing your data? Losing your Apple II!
Guard against break-ins and protect your computer system with
reliable—and inexpensive—security devices.



W By CYNTHIA E. FIELD, Ph.D.

hen thieves broke into an elementary school in a usually peaceful town in southern Rhode Island early last year, they walked away with five cherished and well-worn Apple IIe systems. But worse than the hardware loss was the feeling of personal loss the kids and their teachers experienced. Don Waterous, a second-grade teacher at Peace Dale Elementary School, remembers the incident vividly: “The kids were scared. When the students saw police officers fingerprinting objects, they realized some people had broken into their school.”

The nighttime theft left Peace Dale School computerless for about a month. “It cost me one or two editions of my school newspaper,” recalls Waterous, whose students write and edit their newsletter, *The Bridge*, with Springboard Software’s Newsroom.

Imagine the effect a one-month computing hiatus would have on you—especially if your Apple II helps run your business, teach your class, or balance your checkbook.

LEARN FROM OUR MISTAKES

From the kids and teachers to the town’s school committee, this small community has become more acutely aware of the need for computer security. Like the rest of us who’ve experienced robberies in our homes, businesses, or schools, Peace Dale Elementary didn’t think much about security—until it was too late.

Even the best insurance policy won’t compensate for the fear, ►

SIZZLING DEALS



Introducing BARNEY'S Dog Day Specials

Look for Barney's Bone next to a price point. Order that product on any Wednesday between 11-2PM(PST) You pay UPS Ground Shipping, We Ship it 2nd-day AIR!

SOFTWARE

(Sorry, no software refunds)

- Appleworks GS \$197
- DB Master Professional \$189
- RAMUP 4.0 (RAMdisk Utilities) \$29
- EASY DRIVE (Program Selector) \$54
- Path Finder (AW2.0 patch) \$19
- Late Nite (AW2.0 patch) \$19
- Patch Mania (AW2.0 patch) \$19
- Mini Paint \$22
- TIMEOUT: Ultra Macros \$37
- Graph \$52
- Thesaurus \$52
- Power Pack \$31/ea
- Desk Tools \$31/ea
- Desk Tools II \$31/ea
- ProTERM v2.1 \$79

FOR A COMPLETE CATALOG OF OUR PRODUCTS, FILL OUT THE READER SERVICE CARD IN THIS MAGAZINE

APPLIED ENGINEERING

(additional AE items in stock)

- "0" K Boards now available **Call**
- Timemaster HO \$67
- Z-RAM Ultra 1, 256K \$171
- Z-RAM Ultra 2, 256K \$215
- Z-RAM Ultra 3, 256K \$276
- GS-RAM PLUS, 1 Meg \$299 *(limited quantity)*
- RamWorks Basic, 256K \$155
- RamWorks III, 256K \$171
- Power Supply (II+, //e) \$61
- Serial Pro (Serial Interface w/Clock) \$101
- Transwarp (II+, //e Accelerator) \$129
- Phasor (II+, //e Stereo Card) \$124
- DataLink 2400 (Internal Modem) \$174
- GS RamKeeper \$139
- Ram Express, 256K (//c+) \$186
- Ram Express Clock Option \$49
- Sonic Blaster (GS Stereo Card) \$94
- Parallel Pro (Parallel Card w/Cable) \$74
- Buffer Pro, 32K (for Parallel Pro) \$81
- Transwarp GS \$299
- PC Transporter \$489
- PC Transporter GS installation kit \$37
- Ext. 80 Col. Card \$54

HARDWARE

- Supra 2400 Baud External Modem \$139
- Numeric Keypad (//e) \$49
- Numeric Keypad (//c) \$99
- AMR 30 Meg w/SCSI (//e, GS) \$659
- AMR 43 Meg w/SCSI (//e, GS) \$769
- AMR 60 Meg w/SCSI (//e, GS) \$829
- Kensington System Saver GS \$69
- Meiji 5.25 1/2 Height Drive (//e) \$80
- Meiji 5.25 1/2 Height Drive (//c, GS) \$95
- Meiji 5.25 1/2 Height Drive (//c, GS) Daisy Chainable \$119
- No Slot Clock Pro (Apricorn) \$49
- Parallel Interface Adapter Apricorn (//c) \$49

OUR CUSTOMERS SPEAK...

"I've never found a mail order company that gives this high level of service and great prices too!"

--Timothy W. Starkey, Ph.D. Coral Gables, FL

- Thunderscan (//e, //c, GS Scanner) \$157
- AB Switchbox (Ser/Par) \$29
- AB Switchbox (Mini 8) \$38
- //e Fan and Surge Protector \$34
- GS Sound System 2 speakers & 15watt amp \$119
- Prairie Pwr System, Battery Pack (8 HR, UPS) & Case \$119
- //e Enhancement Kit \$68

CHIPS

All Memory Chips Carry a 5 Year Guarantee!

- CHIPS: (set of 8) 256K, 120ns \$89
- (set of 8) 1 Meg 100 or 120ns \$160



don't miss out on
ROGER'S DEAL OF THE MONTH
PUBLISH IT 2!
Now Desktop Publishing for all Apple //s
list \$129.95
NOW \$74

IF YOU DON'T SEE IT, CALL US!

ORDERS ONLY:
1-800-438-2883
FAX: 1-619-274-2440
15% (\$15/min.) restocking fee

Authorized Applied Engineering Dealer

Roger Coats

P.O. BOX 171466
 SAN DIEGO, CA 92117



PRICE QUOTES & TECHNICAL SUPPORT

1-619-274-1253
8am - 5pm PST
Monday-Friday

Committed to value since 1985

WE ACCEPT: VISA and MasterCard • Bank Wires • School Purchase Orders • Certified Checks • Money Orders • NO PERSONAL or COMPANY CHECKS • Minimum Order \$50 • Sorry, no shipping, handling, or insurance refunds • Not responsible for product compatibility • Prices subject to change without notice • Dunn and Bradstreet Number Upon Request • *FREE Second Day Air Upgrade on Dog Day Special Product Only -- Thanks, Roger & Barney



Circle 90 on Reader Service Card.

“Thieves like to work fast; they generally don’t enjoy frittering away time fiddling with locks and cables.”

anger, and frustration you feel after a break-in. Short of installing an expensive electronic security system, what can you do to ensure that your Apple II stays put when you’re away? Depending on your preferences and the level of security you think you need, you have at least three alternatives to keep your Apple where it belongs—in *your* family room, office, or classroom.

MARK IT

The least intrusive method for protecting your computer components may be simply to mark them with an engraving tool. (See the accompanying sidebar, “Operation Identification.”)

If you prefer not to mar the surfaces of your computer and peripherals with visible engraving, you can opt for the **Securikit** invisible marking system, which uses special ultraviolet pens to tag items. With either type of tool, posting warning stickers can help deter theft, because law-enforcement agencies can trace marked goods more easily.

TIE IT DOWN

A second type of system physically secures your Apple and its related components to a desktop. These materials typically include high-strength, adhesive-backed metal or rigid plastic

mounting plates; vinyl-coated steel cables; and combination or key locks.

Such systems are easy to install, but require a little planning and site preparation. For one thing, you need a special cleaning fluid to prepare surfaces for the adhesive-backed plates.

Some cable-based security kits, like the one sold at Radio Shack stores, include three mounting plates: one for your desktop, one for your Apple, another for your monitor. If yours is a typical Apple II system, you may need expansion kits with extra mounting plates to secure your printer and disk drives.

After attaching the mounting plates, thread the vinyl-coated, twisted-steel cable through them in sequence to tie all peripherals together. One end of the cable has an eyelet to accommodate a combination lock or key padlock. To move your system to another location, simply unlock it, thread the cable back out of the desk-bound mounting plate, and reattach the system to a mounting plate you’ve installed elsewhere.

If you have a number of peripherals spread out on your desktop—or if you want to secure your stereo components or other office equipment while you’re at it—use additional security kits. The cost for protecting thousands of dollars’ worth of equipment is hardly prohibitive: A typical kit costs less than \$50. ▶

PRODUCT INFORMATION

Apple IIs Armor

Omni Tech Corporation
21850 W. Watertown Rd.
Waukesha, WI 53186
(414) 784-4112
\$213.50

Apple IIs Security Kit

Souce System, Inc.
740 Annoreno Drive
Addison, IL 60101
(800) 323-9622
(312) 628-1055
\$49.95

Bretford Microcomputer Security Center

\$393.85
Computer Tabletop Security Enclosures
\$265.30 (4½-inch-wide)
\$182.15 (27½-inch-wide)

Technalock Security Kit (with combination or key lock), \$23.05

Expansion Kit for Technalock (2 extra mounting plates), \$13.90

The Highsmith Company
W5527 Highway 106
P.O. Box 800
Fort Atkinson, WI 53538-0800
(800) 558-2110
(414) 563-9571

Compu-Gard Enclosures

Compu-Gard, Inc.
36 Maple Avenue
Seekonk, MA 02771
(800) 333-6810
(508) 761-4520
\$255

Computer Security Cabinet

Uarco Incorporated
121 North Ninth Street
DeKalb, IL 60115
(800) 435-5555
(800) 345-4335 (IL)
(815) 756-9581
\$200-\$600

Computer Security Lock System

Radio Shack
1500 One Tandy Center
Fort Worth, TX 76102
(817) 390-3011
\$24.95

Kensington Computer Security System

Kensington Microwave Ltd.
251 Park Avenue South
New York, NY
10010-7399
(212) 475-5200
(800) 535-4242
\$49.95

Lock Kit, \$29.95
Cable (additional 5 feet), \$12.95

Security Pads, \$14.95-\$16.95 (depending on size)
Inmac
2465 Augustine Drive

Santa Clara, CA 95054
(800) 547-5444
(408) 727-1970

Securikit

Seton Name Plate Co.
P.O. Box KE-1331
New Haven, CT 06505
(203) 488-8059
(800) 243-6624
\$59.95

Theft Guard PC Cable Scrowlock

\$39.95
Wilson Jones Anti-Theft Alert, \$89.95
Lyben Computer Systems
1050 East Maple Rd.
Troy, MI 48083
(313) 589-3440

Universal Security Kit (USK1)

Grimes Company
115 South
Araovista Circle
Brea, CA 92621
(714) 671-3931
\$49.95

SILICON EXPRESS DISKS
SS/DD 4.95
DS/DD 5.95

VERBATIM OR MAXELL
SS/DD 9.95
DS/DD 10.95

DISK STORAGE
7.95

DISK NOTCHER
3.95

SILICON EXPRESS

**YOUR TOLL FREE ACCESS
CALL...FOR THE
BEST PRICES...BEST DELIVERY**
1-800-999-6868
We have hundreds of other programs in stock at Fantastic savings.

- ACT (Harcourt) 29.95
- Adv. Flight Trainer 25.95
- Adventure Const. 9.95
- Airheart 9.95
- Algeblaster 27.95
- Aliens 9.95
- Alphabet Zoo 18.95
- Ancient Art of War 29.95
- Animate 41.95
- Appleworks 186.95
- Appleworks IIGS 214.95
- Architectural Design 52.95
- ASC II Express 69.95
- Assembly Lines Bk 13.95
- Aussie's Poker 27.95
- Auto Duel 24.95
- Award Maker Plus 23.95
- Bag of Tricks #2 29.95
- Balance of Power 28.49
- Bank Street Filer 48.95
- Bank Street Mailer 17.95
- Bank St. Writer Plus 46.95
- Bard's Tale 28.95
- Bard's Tale II or III 31.95
- Battle Chess 34.95
- Beagle Compiler 45.49
- Beagle Graphics 35.95
- Bnth. Apple Pro DOS 12.95
- Beyond Zork 31.95
- BlackJack Academy 27.95
- Blazing Paddles 24.95
- Blue Powder 34.95
- Body Transparent 29.95
- Bop & Wrestling 18.95
- Bubble Ghost 21.95
- Bus. works Bundle 298.95
- Bus. works Payroll 138.95
- Cad Apples 69.95
- Calendar Crafter 62.95
- California Games 23.95
- Car Builder 29.95
- Carman San Diego Europe 28.95
- Carman San Diego USA 27.95
- Carman San Diego World 24.95
- Certificate Maker 23.95
- Library Vol. 1 19.95
- Chshp. Basketball 9.95
- Chshp. Football 10.95
- Chshp. Lode Runner 21.95
- Chshp. Wrestling 13.95
- Charley Brown ABC 20.95
- Charley Brown 123 20.95
- Chart'n Graph Tibx. 27.95
- Chessmaster 2100 31.95
- Children's Publishing 39.95
- Choplifter 6.95
- Classmates 27.95
- Clip Art Vol. 1, 2 or 3 13.95
- Color Me 27.95
- Commando 9.95
- Commworks 57.95
- Compuserve Starter 21.95
- Concentration 9.95
- Conflict in Vietnam 9.95
- Copy II + 20.95
- Create a Calendar 19.49
- Create w/Garfield 20.95
- Create w/Gar. Del. 27.95
- Crossword Magic 31.49
- Database Toolbox 27.95
- Dazzle Draw 33.95
- DB Master 159.95
- Deathlord 31.95
- Death Sword 20.95
- Decision in Desert 9.95
- Defender of the Crown 30.95
- Del. Paint IIGS 64.95
- Del. Write IIGS 55.95
- Designasaurus 23.95
- Desk Accessories 27.95
- Dsign Yr. Own Train 39.95
- Desk Works 41.95
- Destroyer 13.95
- Dinosaurs 27.95
- Dinosaur Days 27.95
- Dive Bomber 13.95
- Dollars & Sense 69.95
- Draw Plus IIGS 56.49
- Dungeon Master 26.95
- Early Games 21.95
- Easy As ABC 23.95
- 816 Paint 49.95
- Essential Data Dup 4 19.95
- F-15 Strike Eagle 24.95
- Facemaker 26.95
- Factory 32.95
- Family Feud 9.95
- Family Roots 169.95
- Fantavision 29.95
- Fantavision GS 36.95
- First Letters & Words 34.95
- Fish Scales 23.95
- Flight Sim II 31.95
- Font Library 27.95
- 4th & Inches 31.95
- Fraction Factory 17.95
- Fraction Fever 7.95
- Fraction Fuel-Up 23.95
- Game Show 27.95
- Gato 10.95
- Gauntlet 24.95
- GEOS 79.95
- GED Publish 64.95
- Gertrude's Secrets 25.49
- Ghostbusters 9.95
- Grade Buster 64.95
- Grammar Gremlins 27.95
- Grammar Examiner 30.95
- Graphic Exchange 34.95
- Graphics Expander 23.95
- Graphics Magician 25.95
- Graphics Scrapbook 16.95
- Guitar Wizard 20.95
- Hardball 9.95
- Hitchhiker's Guide 9.95
- Hobbit 24.95
- Homeworker 41.95
- Home Video Pro 34.95
- Ikarri Warrior 22.49
- Incredible Lab 31.95
- Infiltrator 19.95
- Interior Design 52.95
- Jeopardy 9.95
- Jet 25.95
- Jigsaw 27.95
- Karateka 9.95
- Kid Writer 25.95
- Kids on Keys 17.95
- Kinder Comp 26.95
- Kings Quest I, II, or III 30.95
- Labels Labels 37.95
- Landscape Design 52.95
- Last Ninja 24.95
- Leather Goddess 9.95
- Legacy of Ancients 25.95
- Leisure Larry I 24.95
- Leisure Larry II 30.95
- Locksmith 38.49
- Lode Runner 6.95
- Magic Spells 24.95
- Magnacharta 41.95
- Man. Your Money 94.95
- Maniac Mansion 22.95
- Marble Madness 10.95
- Master Type 23.95
- Math & Me 22.95
- Math Blaster + 27.95
- Math Blaster Mystery 41.95
- Math Maze 27.95
- Math Rabbit 23.95
- Mavis Beacon 28.95
- Mean 18 29.95
- Megaworks 49.95
- Memory Castle 31.95
- Merlin 44.95
- Merlin 8/16 88.95
- Merlin Pro 69.95
- Micro Cookbook 30.95
- Micro Lg. Baseball 23.95
- Micro Lg. Manager 23.95
- Micro Lg. Team Disk 13.95
- Might & Magic I or II 30.95
- Millionaire II 37.49
- Missing Links 32.95
- Mixed-up Mother Goose 18.95
- Monty Plays Scrabble 31.95
- Mouse Talk 68.95
- MouseWrite 99.95
- Multiscribe 3.0 55.95
- Multiscribe GS 3.0 69.95
- Multiscribe Fonts 13.95
- Music Construction 10.95
- Music Studio 59.49
- NBA Basketball 27.95
- Newsroom 24.95
- Number Farm 23.95
- On Balance 37.95
- 100,000 Pyramid 9.95
- Once Upon A Time 27.95
- Oregon Trail 20.95
- One-On-One 9.95
- Pac Man 9.95
- Paintworks + /Clip 49.95
- Paint Write Draw 89.95
- Paintworks Gold 62.95
- Paperboy 29.95
- Personal Newsletter 38.95
- PFS: File & Report 67.95
- PFS: Graph 64.95
- PFS: Workmates 124.95
- PFS: Write 64.95
- Piece of Cake Math 20.95
- Picture Manager 27.95
- Pinball Construction 9.95
- Pirates 29.95
- Platoon 22.95
- Police Quest I or II 31.49
- Pond 32.95
- Pool Of Radiance 31.95
- Power Print 24.95
- Principal's Assistant 44.95
- Print Magic 37.95
- Printmaster Plus 30.95
- Print Quick 34.95
- Printrix 44.95
- Print Shop 28.95
- Print Shop GS 35.95
- Print Shop Companion 22.95
- Pr. Shp. Gr. #1, 2, 3 14.95
- Print Shop Lessons 32.95
- Pr. Shp. Gr. Sampler 22.49
- Print Shop Holiday 14.95
- Print Shop Party 22.49
- Proterm 89.95
- Publish It 63.95
- Publish-It 2.0 84.95
- Publish It Fonts 24.95
- Publish-It 4 in 1 79.95
- Quicken 30.95
- Rampage 24.95
- Ram-Up 32.95
- Read and Roll 27.95
- Reader Rabbit 23.95
- Reading I or II 27.95
- Reading & Me 27.95
- Reading & Me Talking 34.95
- Red October 27.95
- Report Card 34.95
- Report Works 49.95
- Rocky's Boots 29.49
- Roger Rabbit 24.95
- Run Your Own Train 27.95
- Sargon III 13.95
- Sat (Harcourt Brace) 24.95
- Science Tool Kit 49.95
- Sc. Tool Kit Module 24.49
- Scrabble 27.95
- Sensible Grammar 54.95
- Sensible Speller 67.95
- Sensible Writer 56.95
- Serve & Volley 27.95
- Shanghai 10.95
- Show Off 41.95
- Sideways 42.95
- Silent Service 24.95
- Ski Crazy 20.95
- Skyfox 11.95

- Smart Money 48.95
- Soft Switch 34.95
- Solo Flight 10.95
- Space Quest I, II or III 30.95
- Speed Reader II 41.95
- Spellcopter 24.95
- Spell It 27.95
- Springboard Publisher 79.95
- Fonts 20.95
- Star Fleet I 33.95
- Star Trek 24.95
- Sticky Bear ABC 23.95
- Basic 23.95
- Basket Bounce 23.95
- BOP 23.95
- Drawing 29.95
- Math 1 or 2 23.95
- Music 29.95
- Numbers 23.95
- Opposites 23.95
- Parts of Speech 29.95
- Printer 29.95
- Reading 23.95
- Rd. Comprehension 29.95
- Shapes 23.95
- Spellgrabber 29.95
- Talking Alphabet 29.95
- Train Builder 29.95
- Typing 29.95
- Word Problems 29.95
- Street Sport Baseball 13.95
- St. Sport Basketball 13.95
- St. Sport Football 13.95
- Street Sport Soccer 13.95
- Strike Fleet 24.49
- Sub Battle 13.95
- Sum. Games I, II 13.95
- Super Huey 9.95
- Super Macroworks 30.95
- Take 1 36.95
- Teddy Barrel of Fun 27.95
- Term Paper Writer 33.95
- Terrapin Logo + 79.95
- Test Drive 22.95
- The Games Summer 34.95
- The Games Winter 34.95
- Theodor 22.49
- Think Quick 29.95
- Thinkworks 49.95
- Thunder Chopper 20.95
- Tic Tac Show 27.95
- Timeout Desktools I 30.95
- Timeout Desktools II 30.95
- Timeout Filemaster 30.95
- Timeout Formtools 46.95
- Timeout Graph 51.95
- Timeout Macrotools I 16.95
- Timeout Macrotools II 16.95
- Timeout Powerpack 30.95
- Timeout Quickspell 42.49
- Timeout Sidespread 30.95
- Timeout Spreadsheets 39.95
- Timeout Superfonts 42.49
- Timeout Thesaurus 30.95
- Timeout Ultramacros 34.95
- Times of Lore 27.95
- TML Basic 84.95
- TML Pascal 84.95
- Tomahawk 24.95
- Top Draw 62.95
- Top Fuel Eliminator 20.95
- Tournament Bridge 34.95
- Tower Myrarglen 31.95
- Triple-Dump 24.49
- T-Shirt Maker 9.95
- 2400 A.D. 29.95
- Type! 18.95
- Typing Tutor IV 27.95
- Ultima III 23.95
- Ultima IV or V 35.95
- VCR Companion 31.95
- Vegas Craps 27.95
- Vegas Gambler 27.95
- Victory Road 24.95
- Visualizer IIE 54.95
- Visualizer IIGS 59.95
- Wasteland 31.95
- Webster Spell Chker. 37.49
- Wilderness 20.95
- Will Maker 35.95
- Win Lose or Draw 9.95
- Wings of Fury 21.49
- Winter Games 13.95
- Wizard of Words 27.95
- Wizardry 1.2, 3 or 5 30.95
- Wizardry 4 38.95
- Wrdrl. World of Paws 29.95
- Wheel of Fortune 9.95
- Word Attack + 27.95
- Word Bench 98.95
- Word Master 25.95
- Word Perfect 94.95
- Word Perfect GS 94.95
- World Games 13.95
- Writer Rabbit 29.95
- Writer's Choice 64.95
- Zany Golf 27.95
- Zork Trilogy 34.95
- HARDWARE**
- Apple Mouse 128.95
- Audio Animator 195.95
- Computer Eyes 114.95
- Comp. Eyes IIGS 219.95
- 80 Col. 64K Card (IIE) 49.95
- Datalink Modem 2400 184.95
- Disk Drive Controller 46.95
- Disk Drive American 124.95
- Echo + 134.95
- Enhancement Kit 64.95
- Epic 2400 Classic II 194.95
- Essential Data Dup 4 + 64.95
- Fingerprint GSI 89.95
- Fingerprint Plus 99.95
- Flight Stick 49.95
- Geo Mouse 34.95
- Grappler Plus 69.95
- Grappler Pro 79.95
- Grappler (serial) 60.95
- Grappler C Mac IIGS 84.95
- GS-Ram 256K 179.95
- GS-Ram 512K 295.95
- GS-Ram 1 MEG 524.95
- GS Ram 1 1/2 MEG 754.95
- Hotlink 48.95
- Juice Box 31.95
- Koala Pad + 79.95
- Kraft 2 Button 22.95
- Kraft 3 Button 29.95
- Laser 128 EX 439.95
- Laser 128 EX/2 489.95
- Laser Disk Drive 88.95
- Laser 800 K Drive 184.95
- Laser Mouse 54.95
- Mach III Joystick 34.95
- Mach IV Joystick 62.95
- Mirage 37.95
- No Slot Clock 39.95
- Parallel Printer Card 49.95
- PC Transporter 640K 556.95
- Power Supply IIE 64.95
- Print-It 122.95
- Ram Factor 256K 249.95
- Ram Factor 512K 359.95
- Ram Factor 1 Meg 589.95
- Ramworks 64K 194.95
- Ramworks 256K 204.95
- Ramworks 512K 319.95
- Ramworks 1 Meg 548.95
- Ram Keeper 139.95
- Rocket Chip 169.95
- Serial Pro 114.95
- Sonic Blaster 105.95
- Super Serial Card 64.95
- Super Sonic 54.95
- Surge Protector 13.95
- System Saver Fan 61.95
- System Saver IIGS 72.95
- Thunderscan 177.95
- Timemaster H.O. 78.95
- Transwrap 162.95
- Uni Drive American 149.95
- Univ. Disk Controller 79.95
- Zip Chip 159.95

SILICON EXPRESS
Box 850, Pataskala, Ohio 43062, 1-614-927-9555

Name _____

Address _____

City _____ State _____ Zip _____

Charge # _____ Exp. Date _____

| QTY. | DESCRIPTION | PRICE |
|------|-------------|-------|
| | | |
| | | |
| | | |
| | | |

Computer Type _____ SHIPPING _____

Phone No. _____ TOTAL _____

Add \$3.95 min. U.S. shipping, C.O.D. \$5.00 extra. Hawaii and Alaska \$7.00 min. Orders outside U.S. are not insured. Canada & Mexico 10% min. \$10.00. All other countries 30% min. \$30.00. MasterCard, Visa and school purchase orders accepted. Personal checks allow 3 weeks. 5.5% sales tax for Ohio residents. Defective replaced within 20 days. 20% restocking fee if not replaced with same item. Compatibility not guaranteed. Prices subject to change without notice.

Math Co-processor

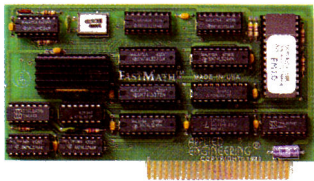

FastMath™

AE's new FastMath™ math co-processor card for the Apple IIGS, IIe and II+ doesn't just crunch numbers - it crushes them. Math functions like multiply, divide, square root, sine, cosine, tangent, arc tangent, logarithms and exponentials will calculate 3 to 12 times faster! The more math your program has, the more improvement you get. Although it works alone, FastMath's accelerations are actually in addition to the speed improvements of an accelerator card. FastMath comes complete with 4 disks of our own Applesoft BASIC Enhancer software, assembly language source code and Macro-controlled firmware for faster *and* more accurate math functions. **\$179**

Order today! To order or for more information, see your dealer or call (214) 241-6060.

AE APPLIED ENGINEERING®

The Apple enhancement experts.

A Division of AE Research Corporation.

P.O. Box 5100, Carrollton, TX (214) 241-6060

Prices subject to change without notice.

II+ OWNERS

WE STILL SUPPORT APPLE II+

SCHOOL P.O.'S WELCOME

APPLE II+ APPLEWORKS!

Also works for Ace 1000

Plusworks 2 will configure your A.W. startup/program diskette to run on your Apple II+ or Ace. Not a preboot, a one-time configure package. (Requires 80 column bd, minimum 64K, & shift key mod) **\$35**

SUPER PRICES ON PERIPHERALS!

- 16K RAM Board** expands II+ to 64K Dos/ProDos compatible **\$34**
- 128K RAM BD** expands II+ to 192K. Combine with Plusworks 2 for an Appleworks desktop to 136K. Will double as 16K RAM bd in slot 0. **\$64**
- DOS/Prodos RAM disk emulator** for above 128K RAM board. **\$24**
- 80 Column BD** expands II+ display to 80 columns. (Videx Compatible) **\$48**
- 40/80 Column Hardswitch for above **\$7**
- 40/80 Column Softswitch for above **\$15**
- Shift Key Modification** **\$7**
- Lower Case Adapter** (Rev 7 & up) **\$12**
- Appleworks 1.2 package** Closeout **\$59**
- Appleworks 1.3 package** Closeout (above not Claris upgradable) **\$79**
- Disk Drive H/H w/speed adjust.** **\$119**
- Disk Controller Board** **\$34**
- SuperFan II** with surge/spike protect, kensington style. **\$27**
- 5 Amp Power Supply** a drop in replacement for II+ supply with double the amperage power. **\$49**

APPLE COMPATIBLE PERIPHERALS!

Low Factory Direct Prices!

- Super Serial Board** 100% replace for Apple Super Serial Card. For all modems & all serial printers. **\$48**
- SSB to imagewriter Cable** 10 ft. **\$12**
- SSB to imagewriter II Cbl.** 10 ft. **\$12**
- SSB to Modem Cable** 10 ft. **\$12**
- Graphic Parallel BD** w/6 ft. cable. Text & graphic screen print. Versatile graphics including normal & inverse, enhanced, 90 degree rotate & double size print. **\$44**
- Parallel Printer BD** w/cable. Used where graphics are not required. Text screen print capability. **\$35**
- Z80 CP/M BD** Opens the CP/M world for the II+. Microsoft and Turbo Pascal compatible. **\$34**
- TV Modulator.** Connect your II+ to any color TV. **\$15**
- Joystick 101** **\$17**
- Joystick III** Similar to the Hayes Mach III w/LG fire button on stick **\$24**
- ZIPCHIP** by Zip Tech. Speeds the operation of your II+ FOUR times faster. Free Diagnostics. **\$149**
- GamePort Extender** **\$5**
- 4 Port GamePort Extender** **\$15**
- Disk Notcher** **\$5**
- Mini Vacuum Cleaner** w/access. **\$15**
- A/B Switchbox** Serial or Parallel **\$29**
- A/B/C/D Switchbox** Ser or Par **\$39**

WE ALSO CARRY PERIPHERALS FOR APPLE IIe-IIc-IIgs

See our ad this issue.

TWO YEAR WARRANTY ON ALL PRODUCTS
CALL OR WRITE FOR OUR COLOR CATALOG
ADD \$3 SHIP C.O.D. OKAY VISA MC NO EXTRA FEE



PRICE BUSTERS (619) 589-0081

4233 SPRING ST., STE. 402, LA MESA, CA 92041
Monday-Friday 10 a.m.-6 p.m. P.S.T.

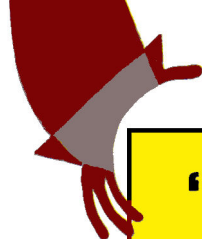

“Imagine the effect a one-month computing hiatus would have on you —

Some cable-based systems, like those offered by **Grimes and Kensington**, have special inserts that lock permanently into the security brackets built into newer Apple products like the IIGS. (Look for the “chain” icon on the left rear panel.) Manufacturers claim that thieves can't remove these security devices, including the adhesive-backed mounting brackets described above, without physically harming the computer's chassis. Damaged goods are worth less to a thief because they're more difficult to fence. Besides, thieves like to work fast; they generally don't enjoy frittering away time fiddling with locks and cables.

The **Wilson Jones Anti-Theft Alert** is a high-tech variant of the cable-based systems already described. This setup, composed of a Master Control Unit and four satellite sensors, links as many as five pieces of equipment in a network. Use the on/off key lock to activate it, much as you would a home-security system. Tamper with the network, and a 98-decibel alarm sounds. If there's one thing thieves hate, it's attention.

HIDE IT

Security cabinets that lock are a third option you can consider

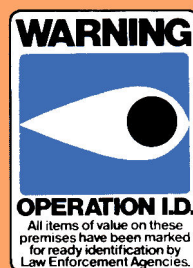

Operation Identification

Statistics prove that "Operation Identification" is an effective way to protect valuable property, including computers, in your home, office,

or school. This project, administered by the Law Enforcement Assistance Administration of the U.S. Department of Justice, is typically run by local police departments.

It couldn't be easier to put Operation Identification to work for you. First, borrow an engraving tool from your local law-enforcement agency and mark valuables with an identifying number. (Some police officers recommend engraving your state driver's-license number, *not* your Social Security number.)

— especially if your Apple II helps run your business or teach your class. ”

for protecting your Apple II system. Costing about \$150 and up, these enclosures may be more suitable for protecting computer systems housed in areas such as classrooms, libraries, or faculty offices. These cabinets conceal a computer system when it's not in use. Out of sight, out of mind, right?

Several security cabinets offer adjustable monitor and keyboard shelves and built-in fluorescent-light fixtures. Some rest on stationary or rolling tables and are ordinarily bolted down or secured in place with high-strength adhesive pads.

KEEP IT SAFE

Follow the adage "Better safe than sorry": You'll enjoy peace of mind knowing your Apple II will be there when you need it—at the office, at school, or at home. □

CONTRIBUTING EDITOR CYNTHIA E. FIELD IS A FREE-LANCE JOURNALIST SPECIALIZING IN COMPUTER-RELATED TOPICS. SHE IS THE AUTHOR OF FIELD TRIP, *INCIDER'S* COLUMN ON EDUCATIONAL SOFTWARE, AND PRESS ROOM, OUR COLUMN ON DESKTOP PUBLISHING. WRITE TO HER AT 60 BORDER DRIVE, WAKEFIELD, RI 02879. ENCLOSE A SELF-ADDRESSED, STAMPED ENVELOPE IF YOU'D LIKE A PERSONAL REPLY.

Second, as you mark items, prepare a list describing them, jotting down their serial numbers and other pertinent information, such as purchase date and price. You should photograph any unmarkable items—jewelry, artwork, collectibles. Keep the list and photos in a safe place, preferably a safety-deposit box.

Third, where practicable, attach the small (1-by-1¼-inch) Operation Identification sticker to each marked item and display 3½-by-5-inch Operation I.D. warning stickers in windows near entrances to your home. Both kinds of stickers are available free of charge from your police department.

According to law-enforcement authorities, Operation Identification really works! Warning stickers serve as effective psychological deterrents to would-be thieves. Marked items are much more difficult to fence, and they provide firm evidence of ownership of stolen goods. □ —C.F.

Computing at Warp Speed

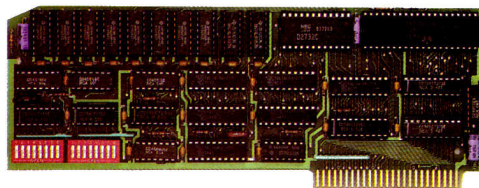

Only with AE's TransWarp™

AE's TransWarp™, the proven accelerator for the Apple IIe, II+ or II, still leads the industry. In recent benchmark tests by a leading Apple II publication, the reliable TransWarp surprised the experts by stacking up quite nicely against the competition.

Full compatibility

But that's only part of the story, because *unlike* others, TransWarp works with ALL Apple standard software including AppleWorks and all educational, graphics and entertainment packages. And unlike others, TransWarp is compatible with ALL standard peripheral cards. You don't have to guess about your specific combinations.

Complete acceleration

Running software *3.6 times faster* is only one reason we were recently selected the All Time Best Accelerator by *Incider Magazine*. The fact is, only TransWarp has 256K of on-board, ultra-fast RAM and accelerates not just main memory, but ROM memory and auxiliary memory as well.



Easier to use

Only TransWarp expands the memory of a 48K II+ or a 64K IIe, and often eliminates the need for a separate memory card. And you won't need to waste time with pre-boot disks because TransWarp is completely transparent. Just plug it into any slot (including slot 3 on the IIe), turn your Apple on and ZOOM . . . off you go at Warp Speed.



"TransWarp is great! I have replaced all my other accelerators with it!"

Steve Wozniak, the creator of Apple Computer

Backed by the leader

And only TransWarp features Applied Engineering's meticulous craftsmanship, 5-year warranty, 15-day money-back guarantee* and our American-made pride.

TransWarp Accelerator \$169

Order today!

To order or for more information, see your dealer or call (214) 241-6060 today, 9 am to 11 pm, 7 days. Or send check or money order to Applied Engineering. MasterCard, VISA and C.O.D. welcome. Texas residents add 7% sales tax. Add \$10 outside U.S.A.

AE APPLIED ENGINEERING®

The Apple enhancement experts.

A Division of AE Research Corporation.

P.O. Box 5100, Carrollton, TX 75011 (214) 241-6060

Prices subject to change without notice.

*When purchased from Applied Engineering or thru a participating dealer.



DATABASE DOINGS

Seeing is believing! Mastering a few AppleWorks tips lets you display all your pertinent database information on screen or paper.

By RUTH K. WITKIN

BELIEVE IT OR NOT, PEOPLE USE DATABASES for all kinds of wild and woolly things. Just yesterday I ran across stories of databases that keep track of kayak races, Yiddish records, relatives on the family tree, daily-exercise regimens, bottles in a wine cellar, and even bird species sighted. Then, of course, there's the more mundane stuff—inventory, customers, employees, accounts receivable, and the like. When you have mountains of details to store and retrieve—whether for pleasure or business—a database is truly a *file cabinet extraordinaire*.

Database jargon is distinctive. In AppleWorks, a database consists of entries, categories, and records. An *entry* is one piece of data, such as the name of a company or a zip code. A *category* is one type of data, such as the name of every company or every zip code. A *record* is a collection of data about one subject—such as company name, contact person, phone number, address, and so on.

I've covered databases in this column before, hitting high spots that can help you develop your skills. Lots more remain as yet not covered—so much material that I've had to split it into two columns. This month you'll create a small database, then use tricks and techniques (known here as *TA-DAs*, as in Big Deals) you may never have tried before. In this session, you'll create a tables report con-

taining category headings but no header—a combination you may think AppleWorks is unable to produce. You'll soon find out it can.

A DATABASE FROM SCRATCH

Let's say you're executive director of the Long Island Bowling Association, an umbrella group that keeps track of island-wide bowling activities and provides news to members and the public. You need a database to hold such information as names, locations, and phone numbers of bowling alleys, types of leagues, when they form, when they bowl, contacts at each alley and each league—a veritable mountain of material that changes with the season.

Relax. You're not going to create all those categories and enter lots of data. To keep things neat and trim, I've limited this database to seven categories, including the perennial spare (in my lexicon, a synonym for *lifesaver*).

When you see such key combinations as OA-Y, hold down the open-apple key and type Y. With repeated combinations, such as OA-Left Arrow (3 times), hold down the open-apple key and tap the left-arrow key three times. If you make a typo, hit the delete key to back up the cursor and erase.

ENTERING CATEGORIES

Load the AppleWorks program and create a new database file named **DBDOINGS**. You should now see the Change Name/Category screen with the cursor on the C in *Category 1*.

Press OA-Y to erase *Category 1*. Type the following category names (in uppercase, to make them stand out), pressing Return after each one:

ALLEY NAME
TOWN
LEAGUE NAME
START DATE
SECRETARY
COUNT
SPARE

Press OA-S to store the database on disk. AppleWorks now advises that you'll go automatically into the Insert New Records feature. Press Return and Record 1 appears, awaiting your entries.

TA-DA 1: SETTING A STANDARD VALUE

The first thing to do when you start a new database is to check the input information for entries that are common to most or all records. When you define these common entries as standard, AppleWorks will enter them in every new record, saving you typing time.

Figure 1 shows the records in this database. The number 1 appears in the COUNT category in every record. The COUNT category is interesting. It lets AppleWorks count every record or selected groups of records in the database—a real plus in a busy database. You'll find out more about this shortly.

Make 1 a standard entry: Press OA-V to bring up the Set Standard Values screen; press the down-arrow key five times to reach the COUNT category, type 1, and press Return. Hit Escape to return to the Insert New Records screen, which now shows the standard entry in Record 1.

FILLING THE RECORDS

Now make the other entries in Record 1. Press the up-arrow key six times to reach the ALLEY NAME category. Type **Baldwin Bowl-O-Rama** and press Return. Type **Baldwin** and ▶

Preferred Computing

AE APPLIED ENGINEERING™

ORDER TOLL FREE! 1-800-327-7234 COD VISA M/C

GS-RAM & GS-RAM Plus These cards offer higher performance and greater expansion capabilities than Apple's card. Includes AE 3.5 Disk Cache, AppleWorks expansion, printer buffer, time display, graphic self diagnostics, DMA compatibility, and much more!

| | |
|--------------------------|-------|
| GS-RAM 256K..... | \$175 |
| GS-RAM 512K..... | \$287 |
| GS-RAM 1 MEG..... | \$511 |
| GS-RAM 1.5 MEG..... | \$735 |
| GS-RAM Plus 1 MEG..... | \$479 |
| GS-RAM Plus 2 MEG..... | \$839 |
| GS-RAM Plus 3-6 MEG..... | CALL |

RamKeeper Boot the GS/OS in 12 seconds. Boot AppleWorksGS in 15. Store programs and data reliably. Battery back-up protection. Allows the use of two RAM expansion cards in the GS' memory expansion slot..... **\$149**

TransWarp GS With this board installed, your IIgs rips along at 7MHz, instead of the stock 2.8 MHz. It boosts program execution speed 2.5 times. Pull down menus fly open. Graphic screens refresh instantly. Spreadsheet calculations, spell checking, etc... 2.5 times faster! Boot up your RamKeeper ROM disk based GS/OS in mere seconds. The IIgs becomes the computer we knew it could be..... **\$319**

Serial Pro™ Multi-function card for IIgs, IIe, & II+. Serial port and a ProDOS clock..... **\$109**

Parallel Pro™ Centronics compatible parallel printer interface. IIgs, IIe, and II+..... **\$79**

Buffer Pro™ Printer buffer option for the Parallel Pro. Allows you to regain control of the keyboard while your printer is working.

Buffer Pro with 32K buffer..... \$84

Buffer Pro with 128K buffer..... \$131

Buffer Pro with 256K buffer..... \$185

Phasor™ Simply the best text to speech synthesizer for the IIgs, IIe, and II+..... **\$129**

Heavy Duty Power Supply Replacement for IIe or II+ with over twice the output of the stock supply. Easy to install..... **\$69**

5 1/4" Half Height Disk Drive. 100% compatible with all Apple software. Works with the IIgs, IIe, IIc, & II+. Compatible with drive ports or Disk Drive Controller. Cable included. **\$119**

5 1/4" Disk Drive Controller Supports Disk II and compatible drives. Has connections for two drives. For the IIgs, IIe, and II+..... **\$59**

RamFactor™ Slot 1-7 memory expansion card. Expands AppleWorks on a IIgs, IIe & II+. RamCharger battery back-up allows permanent storage for instant access to data.

RamFactor 256K..... \$239

RamFactor 512K..... \$351

RamFactor 1 MEG..... \$575

RamCharger Battery back-up..... \$139

DataLink™ 2400/1200/300 baud modem. All hardware, software, & manuals, included. Plus FREE on line services worth over \$200.. **\$189**

DataLink 1200/300 baud modem..... **\$139**

Viewmaster 80™ Super resolution II+ 80 column card. Includes software patch enabling AppleWorks to run on a 64K II+..... **\$124**

Pocket Rocket™ 16K RAM Card Upgrade your II+ to 64K and run ProDOS..... **\$85**

RamWorks III If you have a IIe this card is perfect, and if you use AppleWorks it's an absolute must!

| | |
|----------------------------------|--------------|
| Expands memory up to 3 MEG. | |
| RamWorks III 256K..... | \$199 |
| RamWorks III 512K..... | \$311 |
| RamWorks III 1 MEG..... | \$535 |
| RamWorks III 1.5 MEG..... | \$799 |

RamWorks RGB Options

ColorLink™ For analog RGB and digital RGB style monitors. RamWorks required..... **\$109**

Digital Prism™ For Apple Color 100 and digital style RGB (or CGA) monitors..... **\$109**

512K RamWorks Expander™ Expands all RamWorks cards. Adds 512K..... **\$311**

2 MEG Plus RamWorks Expander™ Expands the RamWorks III, II, and basic.

2 Meg Expander with 1 Meg..... \$519

2 Meg Expander with 2 Meg..... \$879

256K RAMS Set of 8 (150ns)..... \$119

1 MEG RAMS Set of 8..... \$350

1MEG MacRAMS SIMMs for expanding the Mac Plus, SE, and II..... \$365

256K MacRAMS SIMMs for expanding the Mac Plus, SE, and II..... \$139

AE Extended 80 Column card with 64K Upgrade a IIe to 128K plus 80 column..... **\$49**

Timemaster II H.O.™ clock Has the most features and is the easiest to use because it is automatically recognized by ProDOS. Includes AppleWorks time display patch. It even adds 15 new commands to BASIC..... **\$79**

Z-80 Plus Runs all Apple CP/M software. Turbo Pascal, Wordstar, dBase. Includes operating system and manuals. IIgs, IIe, II+..... **\$119**

PC Transporter™ & Accessories

Your Apple IIgs, IIe, or II+ is now the most versatile personal computer you can own. It allows you to run Apple and IBM software on the same computer. Compatible with Apple RGB monitors, printers, hard disks, 3.5 drives, modems, mouse. AppleWorks automatically recognizes the extra memory for expanding desktop memory. The memory can be used as a RAM disk to speed up many other popular Apple programs. It can even support two Apple 3.5" drives running ProDOS.

768K (640K IBM)..... \$519

IIgs Install Kit..... \$40

IIe Install Kit..... \$34

Single TransDrive..... \$209

Dual TransDrive..... \$309

RamExpress™ Memory expansion card for the IIc Plus and original IIc with the expansion connector. Installs inside your computer.

Ram Express 256K..... \$199

Ram Express 512K..... \$311

Ram Express 1 MEG..... \$535

Ram Express Clock Option..... \$49

Z-Ram Ultra Compatible with the IIc.

Ultra 1 256K..... \$199

Memory only 512K..... \$311

Ultra 2 256K..... \$255

Memory, Clock 512K..... \$367

Ultra 3 256K..... \$319

Memory, Clock 512K..... \$431

Z-80 1 MEG..... \$655

TransWarp™ Makes your IIe or II+ run over 3.5 times faster. With 256K of built in accelerator memory. Also emulates a 16K RAM card

in a II+ so you can run ProDOS..... **\$149**

Sonic Blaster AE's full featured stereo digitizer for the IIgs. Amplifies and plays back in full stereo. 1 Meg IIgs recommended..... **\$99**

More Quality Products.

Sony Ultra Hi-Res RGB Monitor/TV

Without a doubt, this RGB monitor/TV is the best available for the IIgs, IIe, bar none!.. **\$529**

Sony digital cable (\$29 sep.)..... \$22

Sony analog cable (\$29 sep.)..... \$22

CH Products Flightstick™..... \$52

CH Products MACH IV™ Plus..... \$69

CH Products MACH III™ Joystick..... \$39

Kensington System Saver® IIe & II+..... \$69

Kensington System Saver® IIgs..... \$74

Turbo Mouse ADB..... \$124

Turbo Mouse..... \$124

ThunderScan®..... \$175

AppleWorks GS..... \$299

Classic AppleWorks version 2.1..... \$199

TimeOut™ Series 2.0 or 2.1 AppleWorks enhancements. IIgs, 128K IIe, or IIc required.

TimeOut UltraMacros..... \$40

TimeOut MacroTools..... \$19

TimeOut MacroTools II..... \$19

TimeOut QuickSpell..... \$49

TimeOut Thesaurus..... \$35

TimeOut Graph..... \$69

TimeOut SuperFonts..... \$49

TimeOut SideSpread..... \$35

TimeOut SpreadTools..... \$40

TimeOut FileMaster..... \$39

TimeOut DeskTools..... \$35

TimeOut DeskTools II..... \$35

TimeOut Powerpack..... \$35

Quicken® Easy home accounting..... **\$36**

Publish It! 2™ Desktop publishing..... **\$89**

VIP Professional™ IIgs Like Lotus 123 .. **\$69**

VIP Professional™ IIe and IIc..... \$69

WordPerfect®IIgs..... \$104

WordPerfect®IIe & IIc..... \$104

SideWays™..... \$38

Deluxe Paint II..... \$59

Managing Your Money 4.0™..... \$98

Where in the World is Carmen Sandiego?..... \$29

Chuck Yeager's Advanced Flight Trainer..... \$34

(10) 5 1/4 DS/DD disk with sleeve..... \$8

(10) 3 1/2 DS/DD disk..... \$15

Why Buy From Us?

1. Toll free 800 number for orders.
2. We almost always ship from OUR stock. Call us before 3 P.M. and it ships today.
3. Memory cards have all factory installed and tested RAM chips.
4. We're nice guys that want to help. We want our business to grow because of repeat customers and word of mouth.
5. We handle only the industry's best. We've tested and used all of the products we sell.
6. 15 day money back satisfaction guarantee on all hardware. If you don't like something, we'll give you your money back. No hassles.
7. We'll support, service and warranty everything we sell.
8. No surcharge is added for charge cards and we won't charge your card until we ship.
9. No sales tax is collected on orders outside Texas.
10. All shipments insured by us.

Order by mail: Send Check or money order to Preferred Computing, P.O. Box 815828, Dallas, Texas. 75381. USA (TX. res. add 7% sales tax)

Order by phone: (800)327-7234 Visa, Master Card, C.O.D., School and Government P.O.'s accepted. Prices subject to change without notice.

Questions and Service: Confused about what to order? Tired of trying to get advice from someone that knows less about Apple Computers than a convenience store clerk? If so, try asking our friendly Apple support staff for honest advice. TX, HI, AK, Outside US (214)484-5464

hit Return again. Type **Thursday Night Men** and hit Return again. Referring to **Figure 1**, enter the start date and secretary name (yes, you can substitute the name of someone you know), pressing Return after each one.

Notice that AppleWorks converted the date you typed as **9/7/89** to *Sep 7 89*—a three-character month, two-character day, and two-character year. That's because the word *DATE* appears in the category name. Now, with the cursor in the **COUNT** category, press **OA-Down Arrow** to bring up Record 2.

Referring to **Figure 1**, fill Records 2-6 the same way. In Record 6, enter the secretary's name and leave the cursor in the **COUNT** category. Press **OA-S** to store the database on disk.

CHANGING THE LAYOUT

Now press **OA-Z** to see the records in multiple-record layout. AppleWorks displays the first five categories with some entries (alley names and league names) truncated, while others (town and start date) have more room than they need.

Figure 1. Records 1-6 in bowling-alley database.

| CATEGORY | RECORD 1 | RECORD 2 |
|--------------|---------------------|---------------------------|
| ===== | ===== | ===== |
| ALLEY NAME: | Baldwin Bowl-0-Rama | Sayville 300 Bowl |
| TOWN: | Baldwin | Sayville |
| LEAGUE NAME: | Thursday Night Men | Sunday Morning Mixed |
| START DATE: | 9/7/89 | 9/10/89 |
| SECRETARY: | Corey Thompson | Larry Merow |
| COUNT: | 1 | 1 |
| SPARE: | | |
| CATEGORY | RECORD 3 | RECORD 4 |
| ===== | ===== | ===== |
| ALLEY NAME: | Plainview Bowl | Hav-A-Ball |
| TOWN: | Plainview | Wantagh |
| LEAGUE NAME: | Tuesday Night Mixed | Women's Wednesday Matinee |
| START DATE: | 9/5/89 | 9/6/89 |
| SECRETARY: | Karen Spolberg | Joan Corallo |
| COUNT: | 1 | 1 |
| SPARE: | | |
| CATEGORY | RECORD 5 | RECORD 6 |
| ===== | ===== | ===== |
| ALLEY NAME: | Village Bowling | Stewart Bowling Center |
| TOWN: | Huntington | Garden City |
| LEAGUE NAME: | Friday Night Mixed | Tuesday Night Women |
| START DATE: | 9/8/89 | 9/5/89 |
| SECRETARY: | Burtie Byrd | Champie LeCatt |
| COUNT: | 1 | 1 |
| SPARE: | | |

FINALLY, A SPREADSHEET YOUR APP

Did you ever wonder why they make professional spreadsheets like Excel™ for Mac's and PC's and not for your Apple II?

We did.

And the more we thought about it, the more it ticked us off. After all, we never met an Apple II that couldn't crunch numbers with the best of them.

So we invented geoCalc.™ The Apple II spreadsheet that excels over any other—calculating, charting and doing dozens of things other spreadsheets can't do, right out of the box.

For about half the money.

EXCELLENT VALUE.

You know who geoCalc's biggest fans are? AppleWorks users. Because geoCalc converts AppleWorks files—with-

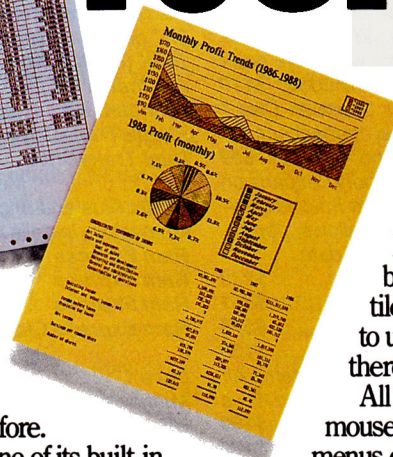
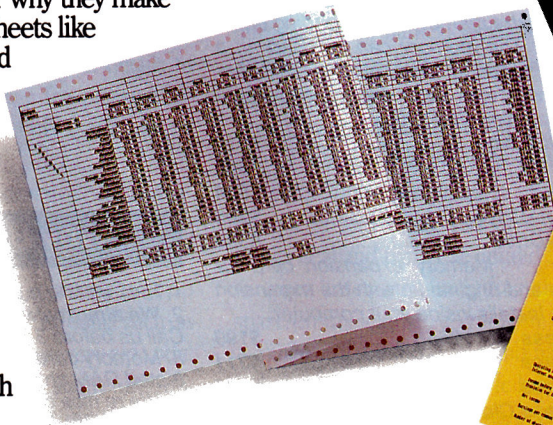

out re-keying—and works them harder than ever before.

And that's only one of its built-in features.

You see, geoCalc can print your spreadsheet sideways. At no extra cost. It can chart your data into any of nine different graphic displays. Again, at no extra cost. In fact, geoCalc comes loaded with all kinds of extra capacity and features that other spreadsheets expect you

to go out and buy separately. Which adds up to quite a bit of savings.

EXCELLENT PERFORMANCE.

Professionals prefer geoCalc because it's much more versatile. And flexible. And easier to use than anything that's out there.

All you do is point and click your mouse or joystick at whichever menus or icons you want. geoCalc takes it from there. You can even choose specific cells or build entire formulas just by pointing and clicking them.

With geoCalc, you can use any of 30 built in functions. Chain them together. Or create and store your very own. All with a few clicks. So if you need a

Figure 2. Report Format screen.

File: DBDOINGS CHANGE NAME Escape: Erase entry
 Report: TABLES
 Selection: All records

--> or <-- Move cursor @-J Right justify this category
 > @ < Switch category positions @-K Define a calculated category
 --> @ <-- Change column width @-N Change report name and/or title
 @-A Arrange (sort) on this category @-O Printer options
 @-D Delete this category @-P Print the report
 @-G Add/remove group totals @-R Change record selection rules
 @-I Insert a prev. deleted category @-T Add/remove category totals

| ALLEY NAME | TOWN | LEAGUE NAME | START DATE | SECR |
|---------------------|-----------|----------------------|------------|------|
| ALLEY NAME | TOWN | LEAGUE NAME | START DATE | SECR |
| -A- | -B- | -C- | -D- | -E-- |
| Baldwin Bowl-D-Rama | Baldwin | Thursday Night Men | Sep 7 89 | Core |
| Sayville 300 Bowl | Sayville | Sunday Morning Mixed | Sep 10 89 | Larr |
| Plainview Bowl | Plainview | Tuesday Night Mixed | Sep 5 89 | Kare |

More --->
 Type title line at cursor position 1031K Avail.

To show more of the long entries, change the column widths: Press OA-L to bring up the Change Record Layout screen. With the cursor in the ALLEY NAME category, press OA-Right Arrow four times to widen the column. Press Tab to move to the following categories and change their widths the same way: TOWN OA-Left Arrow (5 times) LEAGUE NAME OA-Right Arrow (7 times) START DATE OA-Left Arrow (5 times)

Now press the escape key. AppleWorks asks which way the cursor should travel when you press Return. The standard Down is fine, so hit Return. The Review/Add/Change screen returns with categories nicely spaced.

TA-DA 2: COPYING RECORDS

Each alley hosts many leagues, which means that many records will contain the same alley name and town. Names of leagues, start dates, and secretaries will differ. Instead of typing common entries over and over, you can copy a record, keep what applies, and simply over-type the rest.

SHEET THAT MAKES LE II EXCEL.

GROSS REVENUES, well, that's exactly what you do. Want more time saving features?

function to continually project the depreciation on your pet armadillo over the next four trimesters, one click can retrieve it. In fact, geoCalc stores up to 64 of them and recalls each one at the click of a mouse.

Powerful point & click number crunching.

How's this: geoCalc only calculates the parts of the spreadsheet that change, not every cell. Which saves endless processing time.

And when it comes to cutting and pasting, geoCalc cuts and pastes everything. Data. Formulas. Everything.

It even selectively reformats column widths. Simply by stretching them. Now when was the last time AppleWorks helped you out like that?

THE BOTTOM LINE.

Of course, there's one more way that geoCalc excels over every other spreadsheet: It can freely share text and graphics with other GEOS applications like geoWrite, geoPublish and geoFile. Which means your pie charts and tables can be cut and

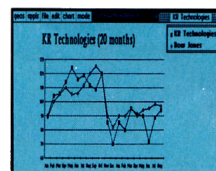

Easily charts data 9 different ways.

pasted into your favorite newsletters, documents and annual reports.

So if your spreadsheet can't keep up with the competition, why not surpass them with geoCalc? It's the most versatile, effortless, complete product out there.

In other words, an absolutely excellent choice.

geoCalc \$69.95
 For orders only, call (800) 443-0100, ext. 234 (California residents add 7% sales tax.) \$4.50 US/\$8.50 foreign shipping and handling. Allow six weeks for delivery.

GEOS, geoCalc, geoFile, geoChart, geoPublish are copyrights of Berkeley Softworks. Apple II, AppleWorks, Excel are trademarks of companies other than Berkeley Softworks. Berkeley Softworks is not a licensee or in any way affiliated with Microsoft.

SYSTEM REQUIREMENTS: Apple IIc, IIc Plus, IIe (or compatibles; IIe need not be enhanced), HGS, with 128K memory, double hi-res graphics capability, joystick or mouse, 5-1/4" disk drive.



The brightest minds are working with Berkeley.

GEOCALC



Circle 295 on Reader Service Card.

WE GET INTO NAME CALLING.

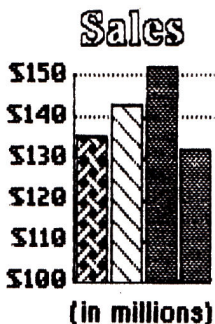

You can also type cell names into formulas, because geoCalc remembers cells by any English names you give them. So if you want to subtract COST OF GOODS from

Press the down-arrow key twice to place the cursor on *Plainview Bowl*. Press OA-C to start the Copy command. AppleWorks highlights the Plainview record and asks what and where you want to copy. Press Return to confirm *Current Record*. Type 2 and hit Return again. You now have three identical records for Plainview Bowl.

Press the down-arrow key to reach the second Plainview record, then OA-Z to enter the single-record screen. Because you're about to overwrite entries, press OA-E to switch to the overwrite cursor (a flashing rectangle).

Press Down Arrow twice to reach the league name, type **Friday Night Men**, press OA-Y to get rid of the excess characters, and hit Return. Change the other entries in Record 5 as follows:

START DATE: **Sep 8 89**

SECRETARY: **Mike Sheridan**

Press OA-Down Arrow to reach the next Plainview record, and make these entries:

LEAGUE NAME: **Monday Afternoon Juniors**

START DATE: **Sep 11 89**

SECRETARY: **Harriet Chong**

Figure 3. Tables report with category names.

| ALLEY NAME | TOWN | LEAGUE NAME | START DATE |
|------------------------|-------------|---------------------------|------------|
| Baldwin Bowl-O-Rama | Baldwin | Thursday Night Men | Sep 7 89 |
| Hav-A-Ball | Wantagh | Women's Wednesday Matinee | Sep 6 89 |
| Plainview Bowl | Plainview | Tuesday Night Mixed | Sep 5 89 |
| Plainview Bowl | Plainview | Friday Night Men | Sep 8 89 |
| Plainview Bowl | Plainview | Monday Afternoon Juniors | Sep 11 89 |
| Sayville 300 Bowl | Sayville | Sunday Morning Mixed | Sep 10 89 |
| Stewart Bowling Center | Garden City | Tuesday Night Women | Sep 5 89 |
| Village Bowling | Huntington | Friday Night Mixed | Sep 8 89 |

You now have all the records you need, so press OA-S to store the database on disk.

CREATING A TABLES FORMAT

Next, create a report format, so that you can explore ways to create headings for a tables report: Press OA-P to start the Print command, and hit Return to confirm *create a new "tables" format*. Type **TABLES** and hit Return again. AppleWorks brings up the Report Format screen showing keystrokes, categories, and entries in the first three records.

In the same way that you changed the width

of the columns in the multiple-record screen, change them in this report format: With the cursor on *ALLEY NAME*, press OA-Right Arrow 11 times; press Tab twice to move to *LEAGUE NAME* and press OA-Right Arrow 14 times. Tab to *START DATE* and press OA-Left Arrow twice. Tab to *SECRETARY* and press OA-Right Arrow four times. Tab to *COUNT* and press OA-Left Arrow nine times.

TA-DA 3: PRINTING CATEGORY NAMES

When you want to print a tables report with category names at the top of columns but without the standard AppleWorks header (file-name, report name, date, and page number), AppleWorks obligingly suppresses the header—but also makes the category names disappear! Quite a dilemma. You have two ways of getting around it, and each has its pluses and minuses.

First, turn off the AppleWorks header: Press OA-O to bring up the Printer Options screen; type **PH** to toggle the *Header to No*, and hit Return. To fit more categories across the page, specify smaller characters: Type **CI** and press Return; type **12** and hit Return again. Now press Escape to return to the Report Format screen. Press OA-S to save the print settings. This last step brings you back to the Review/Add/Change screen. Return to the Report Format screen by pressing OA-P, then hitting Return twice.

Now turn on your printer. To see the printed (but not yet perfect) result, press OA-P to bring up the Print the Report screen. Press Return to confirm the printer (or type the printer number, then Return) and hit Return again to confirm one copy. Things certainly look bare without header or headings.

Figure 2 shows one approach to producing category names at the tops of columns. (Next month you'll explore another.) You're still in the Report Format screen. Press Left Arrow until the cursor reaches *ALLEY NAME*. Now



DESIGN YOUR OWN HOME: LANDSCAPE

Enhance your property and living environment and create the perfect landscape design.

FREE Introductory Offer

FREE landscape Library Disk (\$29.95 value, including 4 dozen landscape designs, with every direct order for **Design Your Own Home: Landscape** (GS: \$89.95; Apple II: \$69.95) ordered by July 31, 1989, that mentions this ad!

1-800-451-4871

CALL TO ORDER



PO. BOX 2440
EUGENE, OR 97402
(503) 342-3030

press OA-N, then Return, to jump the cursor to the line above the category names. Type **ALLEY NAME** and press the spacebar 14 times. Type **TOWN** and hit the spacebar nine times. Continue in this way to enter **LEAGUE NAME** and **START DATE**. After **START DATE**, press the spacebar once so that the cursor is above the *S* in **SECRETARY**, and pause.

The drawback to this method is that you can enter only 78 characters' worth (one screen line) of category names. If you try to scroll to an off-screen category, AppleWorks will beep you. Type **SECRE**. AppleWorks accepts **SECR**, but beeps at *E*. You've typed as many characters as possible. Press Delete five times to erase **SECR** and the space.

Now press Return to enter what you typed and jump the cursor to the first category. Delete the categories without a header: Press the right-arrow key until the cursor reaches the **SECRETARY** category and press OA-D three times. You should now see *Ln75* to the right—the character count of the remaining categories. To see the result of your actions, print the report: Press OA-P, select the printer, and hit Return. Your report should look like the one in **Figure 3**.

If category names plus spaces between them stay within the 78-character limit, this is a quick and easy way to print report headings. The advantage is that category names print at the top of each page. You can also print a report title; use the spacebar to center it. Because AppleWorks allots only one line to headings or titles, you can print one or the other, not both.

NEXT MONTH

Next month, you'll continue working with this database, including printing a more elaborate tables report heading consisting of category names, underscores, and a blank line. You'll also select records and print category names in a labels report. So that we're all at the same place at that time, don't save the alterations between now and then. □

RUTH K. WITKIN IS THE AUTHOR OF THE TEMPLATE/HANDBOOK PACKAGES **SUCCESS WITH APPLEWORKS I, II, AND III** (INCIDER, IDG COMMUNICATIONS/PETERBOROUGH), **MANAGING WITH APPLEWORKS** (HOWARD W. SAMS & CO.), AND **PERSONAL MONEY MANAGEMENT WITH APPLEWORKS** (JOHN WILEY & SONS). WRITE TO HER AT 5 PATRICIA STREET, PLAINVIEW, NY 11803. ENCLOSE A SELF-ADDRESSED, STAMPED ENVELOPE IF YOU'D LIKE A REPLY.

NEW!

LOW FACTORY DIRECT PRICES!

UNIV & SCHOOL P.O.'S WELCOME!

DEALER INQUIRIES INVITED

GS RAM UPGRADES

Increase Your GS RAM For Less!

| | |
|---|--------------|
| Super Expander GS Expands GS to 1.25Meg. A 100% replace for Apple 1Meg Bd. ØK | \$39 |
| Above w/256K | \$114 |
| Above w/512K or 1 Megabyte | call |
| AI 4 MEG GS Board DMA compatible. Expands II GS to 4.25Meg. User Expandable. w/1MG | \$295 |
| Above w/2 Megabytes or 4 Megabytes | call |
| 256K RAM Set (8 piece) to upgrade your 512K GS computer. Also compatible w/AE Bds. | \$80 |
| 1 MEG RAM Set (8 piece) for above 4 Meg GS board, or AE GS-RAM Plus | \$200 |

SOUNDSYSTEM 2 FOR IIgs

New 2-way Stereo Amplified Speaker PAIR! This thunderous amplified speaker set will make all speech, music, games, and other sound programs come to life on your IIgs. Put the S in your GS operations with this Soundsystem 2. Limited time offer.

\$129

WOW! That's \$100 below the Bose Roomates!

1 MEG RAM BOARD IIe/IIc

| | |
|---|--------------|
| Super Expander E For U.S. and European IIe. Licensed by Applied Engineering. A 100% replacement for extended 80 col card. Expands Appleworks desktop to 998K & allows instant switching between A.W. modules. w/ØK | \$59 |
| Above w/256K | \$134 |
| Above w/512K or 1 Megabyte | call |
| Super Expander C Expands IIc to 1152K & A.W. desktop to 1062K, and allows instant switching between A.W. modules. w/ØK | \$69 |
| Above w/256K | \$144 |
| Above w/512K or 1 Megabyte | call |

QUIET COOLING FANS

| | |
|---|-------------|
| SuperFan II For II+/IIe. Kensington Style w/surge protect & twin rear AC outlets. | \$27 |
| Super Cooler GS For the IIgs. No audio line interference. Internal Mount. | \$24 |

ZIPCHIP by ZIP Tech.

For those with the need for speed! Run IIe/IIc/II+ application 4 times faster. Lifetime warranty. Free Diagnostics Software

\$149

PRO-KEYPAD FOR IIe/IIc

| | |
|--|-------------|
| Numeric data entry made simple. Includes mathematic, decimal, & RETURN keys. | |
| PRO KEYPAD IIe for U.S. & Euro IIe | \$34 |
| PRO KEYPAD IIc for U.S. & Euro IIc | \$39 |

NO SLOT CLOCK

| | |
|--|-------------|
| For IIe/IIc. Fits underneath your CD or CF ROM. Appleworks Compatible. Free Sftwr. | \$49 |
|--|-------------|

SUMMER SPECIALS!

| | |
|--|-------------|
| 64K/80 Column Board 100% replacement for Apple extended 80 col card. Features super sharp 80 column display, softswitch select 40/80 columns, dbi hi-res graphic, IIe expansion to 128K (A.W. desktop to 56K) | \$35 |
| Super Serial Board 100% replacement for the Apple Super Serial Card, this versatile serial RS-232 bd can be used for all modems & serial printers. For II+/IIe/IIgs | \$48 |

MORE SUPER SPECIALS!

| | |
|--|-------------|
| Graphic Parallel Board w/6 ft. cable. text & graphic screen prints. Versatile graphics including inverse/normal, enhanced, 90 degree rotate & double size print. | \$44 |
| Parallel Printer Board w/cable. Text print only. Used where graphic is not required | \$35 |
| Z80 CP/M Board Opens the CP/M world for the II+/IIe/IIgs. Microsoft & Turbo Pascal compatible. | \$34 |
| Joystick III. Similar to the Hayes Mach III, with large fire button on stick | \$24 |
| 5 AMP Power Supply. Drop in replacement for II+/IIe supply. Double the amp power! | \$49 |
| TV Modulator. Connects your Apple II+/IIe to any color TV. | \$15 |
| Serial/Parallel Converter. Connects any parallel printer to your IIc. | \$49 |

DISK DRIVES!

| | |
|--|--------------|
| Disk Drive H/H for Apple II+/IIe | \$119 |
| Disk Drive H/H for Apple IIc/IIgs ... | \$119 |
| Disk Controller Board II+/IIe/IIgs ... | \$34 |

SWITCHBOX & CABLES

| | |
|---------------------------------------|-------------|
| A/B Switchbox. Parallel or Serial ... | \$29 |
| A/B/C/D Switchbox. Parallel & Serial | \$39 |
| Serial Cable 10 ft. Male/Male | \$12 |
| Parallel Cable 10 ft. Male/Male | \$12 |

GAMEPORT SWITCHBOX

| | |
|--|-------------|
| Switch between mouse & joystick or any two gameport peripherals. Free master cbl. | \$29 |
|--|-------------|

IMAGewriter II CABLES

| | |
|--|-------------|
| II+/IIe to Imagewriter II thru SSB ... | \$12 |
| IIc to Imagewriter II (Din5 to Din8) | \$12 |
| IIgs to Imagewriter II (Din8 to Din8) | \$12 |

APPLEWORKS CLOSEOUTS!

| | |
|--|-------------|
| Complete package. Startup/program diskette, tutorial diskette, sample templates, & A.W. manual. (Not upgradable by Claris) | |
| Appleworks Version 1.2 Package ... | \$59 |
| Appleworks Version 1.3 Package ... | \$79 |

APPLE II+ OWNERS!

Run Appleworks On Your Computer! See our special II+ ad in this issue.

**5 YEAR WTY PC BOARDS/2 YEAR WTY ALL OTHERS
CALL or WRITE FOR OUR FREE COLOR CATALOG
ADD \$3 SHIP/C.O.D. OKAY/VISA/MC NO EXTRA FEE**

PRICE BUSTERS (619) 589-0081

4233 Spring St., Ste. 402, La Mesa, CA 92041
Monday-Friday 10 a.m-6 p.m. P.S.T.



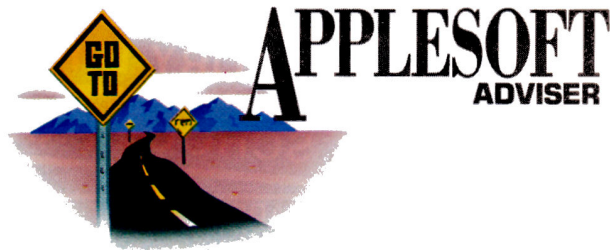

REMARKABLE BASIC

You must REMember this . . . Use plenty of REM statements for clear documentation. The information they provide will help you debug, modify, or convert your programs later.

By DAN BISHOP

PROGRAMS RUN FINE WITHOUT THEM, YOUR COMPUTER ignores anything that follows them, and you'll have more program memory if you avoid them. Yet this month I intend to build a strong case for using the REM statement (short for *remark*) freely in your BASIC programs.

PLAIN ENGLISH

The REM statement, or "comment," is a line of common-language text (English, Spanish, Italian, and so on) that you insert anywhere in a BASIC program to provide information to anyone reading the listing. The computer ignores anything written on the same program line following the REM keyword. During processing, your Apple will jump automatically to the next program line when it encounters a REM.

Usually, REM is the first keyword in a program line. For example:
199 REM SUBROUTINE TO CALCULATE DISTANCE

Presumably, a subroutine that calculates distance begins on line 200 of the program containing this line. It could just as well have read:

```
199 REM $*@%*%@!! CATGUT!
```

Your computer doesn't care, because it ignores everything beyond the REM.

The difference, of course, is that the first example provides helpful information to anyone reading the listing. That's exactly the purpose of a REM statement. You should think out your remarks carefully so that they provide necessary information as concisely as possible to others using the program.

You may also place REM in the middle of the program line. Just remember that the computer will ignore everything else on that line. Precede the REM with a colon, the same way you separate multiple commands that share the same program line. For example:

```
330 X = SQR(Y*Y + Z*Z) : REM FIND HYPOTENUSE
```

Once again, the computer processes everything in this line until

it comes to the REM keyword, then ignores the rest.

PLACEMENT

Remarks are very useful for documenting your programs. You can set aside several lines at the beginning of your program to list its title, the date you created it, and your name. If the program contains a HIMEM: command, that has to come first. But after that (say, lines 2-9) you can use as many comment lines as you need.

If your program contains subroutines, each of those sections should also begin with at least one REM line describing the subroutine's function. That makes it easier to find subroutines when you're trying to debug or modify your program.

Additionally, you can use rows of equal signs or asterisks to further set off a program title or subroutine name. If you'd like to skip lines between sections of code in your printout, you can insert one or more lines containing only the keyword REM, and nothing more. For example:

```
395 REM
396 REM *****
397 REM MAIN MENU DISPLAY SUBROUTINE
398 REM *****
399 REM
400 PRINT "ENTER THE LETTER OF YOUR CHOICE."
405 REM
410 PRINT : PRINT "A. ADD A NEW NAME TO THE LIST"
```

This example might precede a subroutine beginning at line 400 that displays the program's main menu. Note that lines 395, 399, and 405 contain only REM keywords. They have absolutely no effect on the program. They simply space parts of the listing for easier reading.

If you actually ran this example, you'd see a blank line between the instruction ("ENTER...") and the first option ("A. ADD..."). But this one is the result of the extra PRINT command in line 410 and has nothing to do with the REM statements.

Note also that you place the program instructions on lines 400 and 410. If you write the entire program this way, spacing program lines apart by tens and numbering all REM lines in between, you can spot the nonessential REM lines easily. That could be important if the program becomes so long you run out of available memory and have to remove some of the less essential REM lines.

For programs this long, REM lines are especially helpful. The more ►

inCider's Desktop Publishing Contest

SHOW US WHAT YOU'RE PRINTING!

What does desktop publishing mean to you? Font-filled newsletters? Fact-filled newspapers? Fancy greeting cards? Four-foot banners? Whatever your specialty, we want to see what you're up to.



You don't need fancy equipment or a degree in graphic arts to produce eye-catching designs. Last year, inCider's Desktop Publishing Contest attracted over 1000 entries from churches, schools, clubs, and individuals using everything from Newsroom and The Print Shop to Publish It! and Springboard Publisher to DeluxePaint II and PaintWorks Gold.

If you impress us with your creations, we'll publish them in *inCider* and display them in our AppleFest booth. You'll also win thousands of dollars worth of top-selling Apple II hardware and software from Abracadata, Berkeley Softworks, Big Red Computer Club, Claris, Compu-Teach, Electronic Arts, Epyx, Scholastic Software, Seven Hills Software, Softsync Inc., The Learning Co., Thirdware, Thunderware, Timeworks, Tom Snyder Productions, and others!

So what are you waiting for? Send us your best work. Remember: it's not a good publication if no one reads it.

Name _____
Address _____
City _____ State _____ Zip _____
Telephone () _____

Computer used: Apple IIGS _____ Apple II+, IIe, IIc, IIc+,
or compatible _____
Software used: _____
Entry category: School _____ Business _____
Home _____ Nonprofit _____

Deadline for entries: August 15, 1989. Entries cannot be returned.

Mail to: Desktop Publishing Contest
inCider, 80 Elm Street, Peterborough, NH 03458

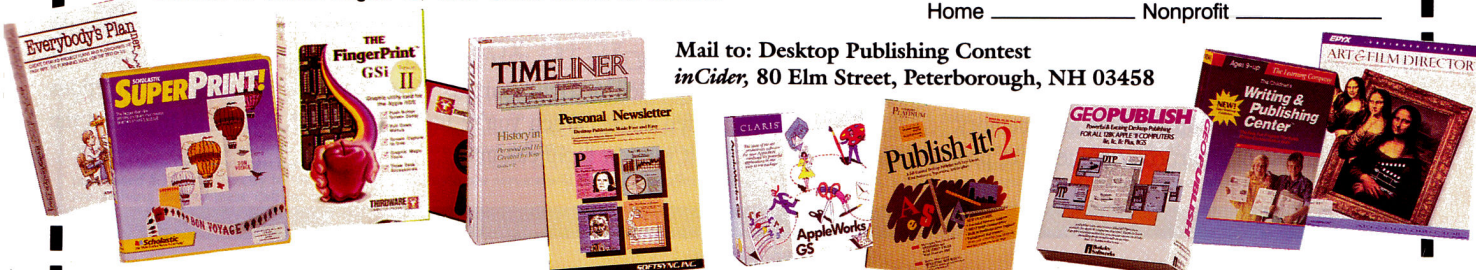

complex the program, the more difficult it is to debug and maintain with adequate documentation. REM statements become a real lifesaver.

What do you do when you need to preserve remarks, but must delete them to make room for additional program lines? The solution is to maintain two copies of the program simultaneously. The first copy contains all your REM statements; it's the one you edit first when you make changes in your program. Keep track of the exact alterations you make as you go along. Then save this copy of the program, and load the one in which you've removed most of the REM statements. Make the same changes in this copy and save it. That's the one you'll RUN.

Be careful to avoid placing REM statements at line numbers that correspond to your program-line sequence. (Use 399 REM, for example, not 400 REM.) This way, you're less likely to accidentally remove a line to which a GOTO or GOSUB command refers. In the previous example, the command to direct program execution to the menu-display routine would be:

```
GOSUB 400
```

Line 400 contains an executable statement, PRINT. Now if you find it necessary to remove lines 395, 396, 398, and 399, you can do so without fear of losing a line to which a GOTO or GOSUB refers. The rule of thumb is to never refer to a line number that begins with REM.

DECLARE YOUR VARIABLES

BASIC is very forgiving when it comes to using variable names in your listing. You simply program along, and when you need a new variable, such as MP, just insert it into the code and keep going. No introductions are necessary. Some other languages, such as Pascal and C, aren't quite so amenable; you have to list the variables you intend to use at the beginning of each block of code and indicate each variable's type (for example, integer, real, or character).

One advantage of a list of variables is that it makes the program considerably easier to read, which in turn makes it easier to debug and maintain. Every serious program, whether written in a language that requires it or not, should have a list of variables near the beginning. It should include the variable name and its definition.

In BASIC, the obvious way to do this is with REM statements immediately following the program title. For example:

```
11 REM X, Y      2D COORDINATES OF A POINT
12 REM ARRY(20)  ARRAY OF DATA VALUES
13 REM DX, DY    INCREMENTS FOR GRID LINES
14 REM I, J      LOOP COUNTERS
15 REM
```

Anyone reading this program listing can glance back quickly to the first page to find out what any variable in the program represents.

AVOID THE OBVIOUS

You may have heard, "The more comments [REM statements] in your program, the better." This advice is aimed at beginning programmers who aren't experienced with complex programming jobs and tend to use too few comments. As with all things, REM statements can be overdone. Using too many remarks may make your program read like a novel, but it wastes valuable time and memory.

If the purpose of a particular sequence of program code is obvious,

there's no sense adding comments about the code, too. For instance:

```
1177 REM
1178 REM ***** INITIALIZE ARRAY
1179 REM
1180 FOR I = 1 TO 200
1190     ARY(I) = 0
1200 NEXT I
1201 REM
```

In this case, the program is obviously using the loop to initialize an array; line 1178 is therefore redundant. On the other hand, depending on the code immediately before and after lines 1180-1200, line 1179 or line 1201 (or both) may be useful to separate this block of code visually from its neighbors in the program listing.

Keep comments short. Complete sentences are rarely necessary. Remember, you insert remarks solely for the reader's benefit. A remark that's clearly understandable in an abbreviated form won't be any more valuable two or three times longer.

DEBUGGING AND TRANSLATION WITH REM

REM also serves as a useful debugging tool. Say you've written a program and you try running it, only to find that it isn't functioning the way you intended. If the problem isn't obvious, try isolating it by blocking out certain program lines temporarily and running the program again. You can also block out time-consuming loops if they aren't essential to the part of the program you're testing. For example, changing

```
3210 XT = RL / (ST + F*F) * 10 ^ (AK - 1)
```

to

```
3210 REM XT = RL / (ST + F*F) * 10 ^ (AK - 1)
```

effectively blocks line 3210 from processing the next time you run the program.

To block out a line of code, simply enter the word REM on the same line, right after the line number. To avoid retyping the line from scratch, first LIST it (for example, LIST 2240), then press Escape to put your Apple into "move cursor" mode. Now press I, M, J, or K as needed to move the cursor up, down, left, or right. Position the cursor on top of the first digit in the line number and press Escape again. Press the right-arrow key to move the cursor one character at a time across the line number to the space immediately following. This is where you'll type REM.

If you type REM right now, though, it will overstrike other characters; to avoid that, hit Escape, press I once to move the cursor above the line, then press Escape again. Now type (space)REM(space), and hit Escape. Next, press M once, then J four times, and hit Escape.

Finally, hold down the right-arrow key until the cursor has sped through the rest of the line of code, and press Return. You've just edited the line of code by inserting REM at the beginning of the line. List it again to be sure you didn't accidentally clobber it.

The only cases in which this technique won't work are with program lines containing quoted items (such as PRINT or INPUT commands) and DATA statements. For these, enter POKE 33,33 before you do anything else. This narrows the edit window so that the program line has no left or right margins. Then continue following the directions stated above. When you're finished, enter POKE 33,40 to return the edit window to 40 columns.

SOFTWARE DISCOUNTERS OF AMERICA



USA Canada Orders—1-800-225-7638
PA Orders—1-800-223-7784
Customer Service 412-361-5291

- Free shipping on orders over \$100 in continental USA
- No Surcharge for VISA/MasterCard
- Your Card is not charged until we ship

ORDER LINE HOURS: Mon.-Thurs. 9:00 AM-9:00 PM Fri. 9:00 AM-7:00 PM Sat. 10:00 AM-4:00 PM Eastern Time.

ACCOLADE

The Duel

THE DUEL is on. Head to head racing between a Ferrari F40 & a Porsche 959! Also available for use with Test Drive 2 are Calif. Challenge Scenery & Super Cars

Test Drive 2: The Duel
List \$44.95
SDA Discount Price \$29

II GS Only

- ACCOLADE**
- Bubble Ghost GS ... \$25
 - 4th & Inches Football GS\$29
 - 4th & Inches
 - Team Const. GS ... \$9.88
 - Hardball ... \$9.88
 - Hardball GS ... \$25
 - Mean 18 Golf GS ... \$25
 - Famous Course Disks #2
 - For Mean 18 GS ... \$14
 - Famous Course Disks #3 & #4 for Mean 18 GS ... \$23
 - Mini Putt GS ... \$25
 - Serve & Volley GS ... \$25
 - Test Drive 128K ... \$23
 - T. Drive 2: The Duel GS\$29
 - T.D. 2 Calif. Scenery GS\$14
 - T.D. 2 Super Cars GS ... \$14
- ACTIVISION**
- Battle Chess GS ... \$32
 - Black Jack Academy GS\$25
 - Last Ninja 128K ... \$23
 - Last Ninja GS ... \$25
 - Maniac Mansion 128K \$23
 - Might & Magic 1 or 2 \$32
 - Music Studio 2.0 GS ... \$65
 - Neuromancer 128K ... \$29
 - Neuromancer GS ... \$29
 - Paintworks Gold GS ... \$65
 - Paint/Write/Draw GS ... \$79
 - Rampage 128K ... \$23
 - Shanghai ... \$9.88
 - Teleworks Plus GS ... \$65
- ALTURAS**
- MAXX Control Yoke ... \$69
- AMERICAN EDUCATIONAL**
- Return of the Dinosaurs\$24
- ARTWORK**
- Bridge 5.0 ... \$19

- Wings of Fury 128K ... \$23
- CENTRAL POINT**
- Copy 2 ... \$25
- CINEMAWARE**
- Defender of Crown GS\$32
 - King of Chicago GS ... \$16
- DATA EAST**
- Bad Dudes ... \$23
 - Ikari Warriors 128K \$9.88
 - Platoon 128K ... \$23
- DAVIDSON**
- Algeblaster ... \$29
 - Grammar Gremlins ... \$29
 - Math Blaster Plus 128K\$29
 - Math & Me 128K ... \$23
 - Read 'N Roll 128K ... \$29
 - Reading & Me 128K ... \$23
 - Spell It ... \$29
 - Talking Math & Me GS\$32
 - Talking Reading & Me GS\$32
 - Word Attack Plus 128K\$29
- DESIGNWARE**
- Designasaurus 128K ... \$25
 - Designasaurus GS ... \$32
 - Jigsaw GS ... \$25
- ELECTRONIC ARTS**
- Bard's Tale ... \$29
 - Bard's Tale 2 or 3 ... \$32Ea.
 - Bard's Tale 1 or 2 GS\$32 Ea.
 - Chessmaster 2100 ... \$26
 - Chessmaster 2100 GS ... \$32
 - Chuck Yeager's AFT ... \$26
 - Death Lord ... \$9.88

- World Games 128K ... \$14
 - World Games GS ... \$14
- FTL**
- Dungeon Master GS ... \$25
- GAMESTAR**
- Champ. Baseball ... \$9.88
 - Champ. Basketball GS \$29
 - Champ. Basketball ... \$9.88
 - Champ. Football ... \$9.88
 - Star Rank Boxing 2 ... \$9.88
 - *All II e/c titles require 128K!
- GAMETEK**
- Hollywood Squares ... \$9.88
 - Super Password ... \$9.88
 - *All titles req. 128K!
- HI-TECH EXPRESSIONS**
- Big Bird's Spc. Delivery\$6.88
 - Desk Power ... \$9.88
 - Ernie's Magic Shapes \$6.88
 - Fun House ... \$29
 - Muppet Adventure ... Call
 - Muppet Print Kit ... \$9.88
 - Print Power ... \$9.88
 - Remote Control ... \$8.88
 - Sesame St. Print Kit ... \$9.88
 - Sesame St. Writing Kit Call
 - Win, Lose or Draw ... \$8.88
- INFOCOM**
- Battletech ... \$32
 - Beyond Zork 128K ... \$9.88
 - Hitchhikers Guide ... \$9.88
 - Leather Goddesses ... \$9.88
 - Shogun ... \$32

2 New Share Data Hits At Low SDA Prices!

Jeopardy Jr. Edition \$9.88 Each

Concentration 2nd Edition

- Tangled Tales ... \$19
 - Times of Lore ... \$25
 - Ultima 4 or 5 ... \$39 Ea.
 - Ultima Trilogy ... \$39
- SHARE DATA**
- Concentration 1 or 2\$9.88
 - Jeopardy Jr. ... \$9.88
 - Sports Jeopardy ... \$8.88
 - Wheel of Fortune 3 128K\$9.88
- SIERRA**
- Black Caldron GS ... \$25
 - Gold Rush GS ... \$25
 - King's Quest 1, 2, 3 or 4 128K or GS ... \$32 Ea.
 - Leisure Suit Larry GS ... \$25
 - Leisure Suit Larry 128K\$25
 - Manhunter GS ... \$32
 - Mother Goose 128K ... \$19
 - Mother Goose GS ... \$19
 - Police Quest GS ... \$32
 - Police Quest 128K ... \$32
 - Space Quest 128K ... \$32
 - Space Quest 2 (128K) ... \$32
 - Space Quest 1 or 2 GS\$32 Ea.
- SIR TECH**
- Heart of Malestrom ... \$32
 - Knight of Diamonds ... \$32
 - Legacy of Lygamin ... \$32
 - Proving Ground ... \$32
 - Return of Werdna ... \$39
- SPRINGBOARD**
- Atlas Explorer ... \$32
 - Certificate Maker ... \$24
 - C.M. Library Vol. 1 ... \$19
 - Newsroom ... \$23
 - N.R. Clip Art 1, 2, 3 ... \$14
 - Publisher 128K ... \$84
 - SSI
 - Demon's Winter ... \$21
 - First Over Germany ... Call
- Overrun ... \$32
 - Phantasia 3 ... \$26
 - Pool of Radiance ... \$39
 - Roadwar 2000 GS ... \$29
 - Typhoon of Steel ... \$32
- SUBLOGIC**
- Flight Simulator 2 ... \$32
 - Jet ... \$26
- TAITO**
- Arkanoid ... \$19
 - Arkanoid GS ... \$23
- THREE SIXTY**
- Dark Castle GS ... Call
 - Warlock GS ... \$24
- TIMETWORKS**
- Graph It! ... \$44
 - Publish It Clip Art ... Call
 - Publish It! 2 ... \$84
- UNICORN**
- Aesop's Fables GS ... \$29
 - All About America GS \$39
 - Animal Kingdom GS ... \$29
 - Magical Myths GS ... \$29
 - Magic Wizard GS ... \$29
- WEEKLY READER**
- Stickybear Series:
 - ABC's ... \$24
 - Math 1 or 2 ... \$24
 - Numbers ... \$24
 - Reading ... \$24
 - Spell Grabber ... \$32
 - Talking Alphabet GS ... \$32
- WORD PERFECT**
- Word Perfect ... \$97
 - Word Perfect GS ... \$97
- ACCESSORIES**
- Sony 3 1/2 DSD\$16.90 Bx.
 - Sony 5 1/4 DSD\$16.99 Bx.
 - Wico Ergostick ... \$25

Ask your salesperson: "What's on Sale this Month?"

- Deluxe Paint II GS ... \$65
 - Hunt For Red Oct. ... \$26
 - Instant Music GS ... \$14
 - Instant Synthesizer GS \$49
 - Legacy of Ancients ... \$9.88
 - Lords of Conquest ... \$9.88
 - M. Beacon Typing GS ... \$29
 - Madden Football ... \$32
 - Magic Candle ... \$32
 - Marble Madness 128K\$9.88
 - Marble Madness GS ... \$14
 - Music Const. Set GS ... \$14
 - Pegasus ... \$9.88
 - Reach for the Stars GS\$26
 - Skate or Die GS ... \$26
 - Strike Fleet ... \$23
 - Wasteland ... \$32
 - World Tour Golf GS ... \$14
 - Zany Golf GS ... \$26
- EPYX**
- Art & Film Director GS\$49
 - California Games GS ... \$29
 - California Games 128K\$24
 - Destroyer GS ... \$14
 - Final Assault GS ... \$14
 - Home Video
 - Producer 128K ... \$32
 - Impossible Mission 2 ... \$14
 - L.A. Crackdown 128K \$19
 - Print Magic 128K ... \$32
 - S.S. Baseball 128K ... \$14
 - S.S. Basketball 128K ... \$14
 - S.S. Football ... \$14
 - Street Sports Soccer GS\$14
 - Sub Battle Sim. GS ... \$19
 - Summer Games 1 or 2\$14 Ea.
 - The Games:
 - Summer Edition 128K\$32
 - Winter Edition 128K \$32
 - Technocop ... \$24
 - Winter Games GS ... \$14
- Zork Trilogy ... \$32
 - Zork Zero ... \$32
- LEARNING COMPANY**
- Math Rabbit ... \$24
 - Reader Rabbit GS ... \$39
 - Reader Rabbit ... \$24
 - Think Quick! ... \$32
 - Writer Rabbit ... \$32
- MASTERTRONIC**
- Risk ... \$26
 - Scrabble ... \$26
 - Scrupples ... \$26
- MECA**
- Andrew Tobias: Managing Your Money ... \$95
- MELBOURNE HOUSE**
- Elway's Quarterback ... \$19
 - War In Middle Earth GS\$32
- MICROPROSE**
- F-15 Strike Eagle ... \$23
 - Pirates 128K or GS\$25 Ea.
 - Silent Service ... \$25
 - Silent Service GS ... \$25
- MINDSCAPE**
- Balance of Power 128K\$25
 - Balance of Power 1990 GS\$32
 - Captain Blood GS ... \$29
 - De Ja Vu 1 or 2 GS ... \$32
 - Gauntlet 128K ... \$25
 - Gauntlet 2 (128K) ... Call
 - Gauntlet GS ... \$29
 - Hostage GS ... Call
 - Paperboy GS ... \$25
 - Perfect Score SAT ... \$44
 - Super Star Ice Hockey 128K\$25
 - Super Star Ice Hockey GS\$29
 - Uninvited GS ... \$29
- ORIGIN**
- Autoduel ... \$25
 - Moebius ... \$25

HI TECH EXPRESSIONS

So much for so little. Powerful Word Processor. Address & Telephone Book. Calculator. Calendar. Scheduler & Appt. Book. Note Pad.

Desk Power
List \$14.95
SDA Discount Price \$9.88

ORIGIN SYSTEMS INC.

Throw on the robes of a struggling wizard's apprentice & step into a world of myth, magic & madcap adventure.

Tangled Tales
List \$29.95
SDA Discount Price \$19.00

P.O. BOX 111327—DEPT. INC—BLAWNOX, PA 15238

*Please Read The Following Ordering Terms & Conditions Carefully Before Placing Your Order: Orders with cashiers check or money order shipped immediately on in stock items! Personal & Company checks, allow 3 weeks clearance. No C.O.D.'s! Shipping: Continental U.S.A.—Orders under \$100 add \$3; free shipping on orders over \$100. AK, HI, FPO, APO-add \$5 on all orders. Canada & Puerto Rico-add \$7.50 on all orders. Sorry, no other International orders accepted! PA residents add 6% sales tax on the total amount of order including shipping charges. CUSTOMER SERVICE HOURS: Mon.-Fri. 9 AM-5:30 PM Eastern Time. REASONS FOR CALLING CUSTOMER SERVICE—412-361-5291 (1)Status of order or back order (2)if any merchandise purchased within 60 days from S.D.of A. is defective, please call for a return authorization number. We will not process a return without a return auth. #! Defective merchandise will be replaced with the same merchandise only. Other returns subject to a 20% restocking charge! After 60 days from your purchase date, please refer to the warranty included with the product purchased & return directly to the manufacturer. Customer service will not accept collect calls or calls on S.D.of A.'s 800# order lines! Prices & availability are subject to change! New titles are arriving daily! Please call for more information.

MODERN OWNERS: You can order on-line from our APPLE Shop via the CompuServe and Gencis electronic malls.

NOW HEAR THIS! DIVERSI-TUNE™ IS THE BEST!

DIVERSI-TUNE was chosen as the best Apple IIgs music program by Applelink subscribers! Why? Great Sound! Family sing-a-long fun! And full-power MIDI capability!

"Outstanding!!! Everyone in the store cannot believe how great the sound is. I think if I turned the volume control up it would break out my windows!" - John Licari, Rock Valley Computers, Rockford, IL

"DIVERSI-TUNE's sound quality is unmatched... The music is crisp, clear and, most noticeably, avoids the typical static heard on more expensive programs" - Apple IIgs Buyer's Guide

"DIVERSI-TUNE makes your GS sound like a compact-disc player... Teachers will like the keyboard diagrams showing proper finger placement/ Because of DIVERSI-TUNE, inCider's alive with the sound of Apple music. We hear that real musicians love it, too." - inCider Editors' Choice/Top Ten Star.

"The screen displays the words to the song and - a bouncing ball! I found that it was just like magic, seeing (and hearing) the family all together around the Apple, singing like meadowlarks. This is fun gang." - Washington Apple PI Journal.

"I am thrilled with this program! You have carried me back to my childhood days when we used to go over to a neighbor's house and spend the afternoon playing the piano and singing along. I couldn't believe my ears when I heard what was coming from my IIgs!" - Dorothy F. Bell, Lynchburg, VA.

"DIVERSI-TUNE is a remarkable product, one that brings together playback audio quality for musical couch potatoes, turns the IIgs into a good-quality instrument for hands-on musicians, and provides a flexible and powerful MIDI recorder. It's truly an all-in-one music studio." - A+ Magazine.

DIVERSI-TUNE... Program Disk... \$75.00

Once you have DIVERSI-TUNE, you can add to your fun by ordering a whole variety of pre-recorded song disks:

- #101 Nathan Page Live Jazz Piano... \$29.95
- #102 Gay Nineties... \$19.95
- #103 American Folk/Patriotic... \$19.95
- #104 Christmas Songs... \$19.95
- #105 Jewish Songs... \$19.95
- #106 Gospel Songs... \$19.95
- #107 Nathan Page Studio Jazz... \$29.95
- #108 Classical Organ Favorites... \$29.95
- #109 Classical Harpsichord Duets... \$29.95
- #110 Bill Basham - Rock Improv... \$29.95

Yamaha DM-01 Speakers... \$99.00

The best sounding amplified stereo mini-speakers, with volume and tone controls! (Quantities limited. Add \$4 shipping - US only).

ORDER TOLL FREE

800-835-2246 ext. 127 (orders only)
313-553-7822 (dealers and foreign orders)
313-553-9460 (technical questions)

Price includes 1st class postage to US/Canada. Foreign orders add \$5 airmail fee. Return for full refund within 30 days if not satisfied. Visa/MC (with exp. date), checks, P.O.'s accepted.

DEALER INQUIRIES INVITED

Diversified Software Research, Inc.
34880 Bunker Hill
Farmington Hills, MI 48331-3236 

Circle 108 on Reader Service Card.

APPLESOFT ADVISER

If the program bug disappears after you've "commented out" several suspicious lines of code, you'll probably want to look closely at those lines. They may contain the source of the problem. If the bug is still present, you might conclude, at least for the time being, that the edited lines aren't the problem and continue looking elsewhere.

Using REM is also helpful when you're converting programs to Applesoft BASIC. Other languages, even other "dialects" of BASIC, contain constructs and commands Applesoft doesn't recognize; you'll have to rewrite parts of the original code into their Applesoft equivalents. Keep it in the program until you've tested the new block and determined that it's working properly.

Of course, you can't just leave the original code in your program as is—the Applesoft interpreter will find it and the program will crash. But if you precede the original code segments with REM, they can remain right where they are without affecting the program.

For example, consider the ELSE portion of an IF/THEN/ELSE/ENDIF command in FORTRAN. Applesoft has neither an ELSE nor an ENDIF. You might translate FORTRAN code that looks like the following:

```
IF (XY .EQ. RT) THEN
  X = SQRT(P*B + 12.00)
  Y = X * X
ELSE
  X = SQRT(R*Q - 12.00)
  Y = Q * Q
ENDIF
```

Your BASIC translation might look like this:

```
860 IF XY <> RT THEN GOTO 900
864 REM
865 REM *** IF (XY .EQ. RT) THEN***
870 X = SQR(P*B + 12.00)
880 = X * X
890 GOTO 920
899 REM *** ELSE ***
900 X = SQR(R*Q - 12.00)
910 Y = Q * Q
911 REM *** ENDIF ***
912 REM
920 (rest of program)
```

As you can see, the FORTRAN code is still present; it's just been commented out. If you're looking for bugs in your translation, you'll find them much more easily if you can read the original code at the same time you're scanning through your own code.

It's hard enough deciphering someone else's program listing when there are few or no comments; it's downright embarrassing to look at your own program code from a year ago and not be able to figure out what you did. REMs alleviate much of this anxiety—programs are easier to debug, easier to understand, and easier to modify in the future. □

DAN BISHOP OWNS AND OPERATES A MICROCOMPUTER CONSULTING BUSINESS. WRITE TO HIM AT 4124 BEAVER CREEK DRIVE, FORT COLLINS, CO 80526. ENCLOSE A SELF-ADDRESSED, STAMPED ENVELOPE IF YOU'D LIKE A PERSONAL REPLY.

You probably already know that Computers Need Maintenance!

But did you know that with **Intelligent Tools** your computer can maintain and diagnose itself?

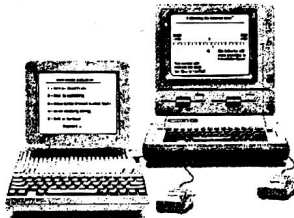

MASTER DIAGNOSTICS™

Master Diagnostics provides all of the tools and knowhow necessary so that *anyone* can do monthly maintenance duties. Calibrating disk drive speed, cleaning drive heads, checking track alignment or just adjusting your monitor to peak clarity is a snap.



In addition to the maintenance routines, extensive diagnostic procedures are available at the touch of a key. With our new diagnostic construction set; you can create peripheral diagnostics for any device card. Problems are diagnosed down to the chip level and tests will report: *what's right, what's wrong, what to do and how to do it.* Not just pass-fail type exams!

The user manual is easy to understand and is packed with money saving U-DO-IT information. The Drive Analyzer tests and calibration routines alone will pay for Master Diagnostics after using it just once.

Expert Opinions

Nibble magazine says, "This program should be in the library of every Apple user". Howard Sams Tech Manual, Apple Orchard, inCider Popular Computing, and the Apple II Review have all awarded Master Diagnostics with triple AAA ratings. *Consumers Guide* chose Master Diagnostics as one of the best programs for 1985. Used by Apple service centers world-wide.

WHEN ORDERING SPECIFY:

version:  II+,  IIe or  IIc

Master Diagnostics - \$75.00 r 6.1

Drive Analyzer alone - \$39.95
(Included with MD)

Visa, MC, COD, School PO's

Call Free 1-800-835-2246

Apple Diagnostics
Since 1979

NIKROM

Technical Products, Inc.

176 Fort Pond Road ♦ Shirley, MA. 01464

Upgrades - return
diskette and \$20.00

CDA Computer Sales

Ad #16-07

The Affordable Source for Apple® Hardware, Software & Accessories

Apple Computers

| | |
|-----------------|--------|
| Apple IIGs 256K | \$ 835 |
| Apple IIGs 512K | \$ 895 |
| Apple IIC Plus | \$ 499 |

Monitors

| | |
|--------------------|--------|
| Apple Color RGB | \$ 465 |
| Color Monitor IIC | \$ 339 |
| Color Monitor IIC | \$ 312 |
| Apple Monochrome | \$ 135 |
| Magnavox RGB/Comp. | \$ 299 |

Floppy & Hard Drives

| | |
|----------------------------|--------|
| Apple 3.5 Disk Drive | \$ 349 |
| Apple 3.5 UniDisk IIe/c | \$ 319 |
| Applied 5.25 Disk Drive | \$ 118 |
| UniDisk 3.5 Controller | \$ 59 |
| Apple 5.25 Disk Drive | \$ 259 |
| Apple 5.25 UniController | \$ 59 |
| Laser 3.5 Drive IIe or IIC | \$ 189 |
| Laser 3.5 Controller | \$ 76 |
| Laser 5.25 Drive | \$ 89 |
| CMS 20 Meg w/SCSI | \$ 627 |
| CMS 30 Meg w/SCSI | \$ 678 |
| CMS 43 Meg w/SCSI | \$ 786 |
| CMS 60 Meg w/SCSI | \$ 850 |

Printers

| | |
|------------------------|--------|
| ImageWriter II w/Cable | \$ 459 |
| Epson LX-800 | \$ 209 |
| Panasonic KX-P1180 | \$ 219 |
| Panasonic KX-P1190 | \$ 279 |
| Olympia NP-30 w/Cable | \$ 289 |

Printer Interface Cards

| | |
|------------------------|--------|
| Apple Super Serial | \$ 109 |
| Applied Serial Pro | \$ 109 |
| Applied Parallel Pro | \$ 79 |
| Orange Grappler C/M/GS | \$ 79 |
| Orange ProGrappler | \$ 82 |
| Thirdware Fingerprint | |
| GSI Plus | \$ 85 |

Memory Upgrades

We sell only pure Applied Engineering Memory Cards. Complete with 5 year warranty!

| | |
|------------------------|--------|
| Applied GS-RAM 0K | \$ 89 |
| Applied GS-RAM 256K | \$ 169 |
| Applied GS-RAM 512K | \$ 279 |
| Applied GS-RAM 1 Meg | \$ 498 |
| Applied GS-RAM 1.5 Meg | \$ 709 |
| GS-RAM Ultra 256K | \$ 185 |
| GS-RAM Ultra 512K | \$ 295 |
| GS-RAM Ultra 1 Meg | \$ 509 |
| GS-RAM Ultra 2 Meg | \$ 815 |
| GS-RAM Plus 1 Meg | \$ 465 |
| GS-RAM Plus 2 Meg | \$ 815 |
| RamKeeper | \$ 142 |
| RamKeeper Slot Mover | \$ 32 |

| | |
|-------------------------|--------|
| RamWorks III 256K | \$ 189 |
| RamWorks III 512K | \$ 299 |
| RamWorks III 1 Meg | \$ 519 |
| RamFactor 256K | \$ 229 |
| RamFactor 512K | \$ 339 |
| RamFactor 1 Meg | \$ 559 |
| RamCharger Backup | \$ 145 |
| Ram Express 256K | \$ 189 |
| Ram Express 512K | \$ 299 |
| Ram Express 1 Meg | \$ 539 |
| Clock Option | \$ 49 |
| Checkmate Mem Saver | \$ 119 |
| Apple Memory Card | |
| 256K for IIGS | \$ 129 |
| Applied Ingenuity Extd. | |
| 80 Column 64K IIC | \$ 49 |

Apple IIGs® 512K Color System



Complete system includes:

- Apple IIGs 256K CPU w/Mouse & Pad
 - Apple Color RGB Analog Monitor
 - Apple 3.5" Disk Drive
 - Apple 5.25" Disk Drive
 - Apple ImageWriter II 220 cps Printer
 - ImageWriter II Cable
 - Apple Memory Card with 256K
 - Color Rainbow Ribbon
 - 3.5" Diskettes-Box of 10
 - 5.25" Diskettes-Box of 10
 - Dust Covers for IIGs & ImageWriter II
 - Computer Paper-Pkg. of 500
- Package #8920
Suggested List Price \$3257

CDA Price \$2399
Save Over \$850!

Upgrade your IIGs, IIC, or IIC Memory card. Most memory cards take the 150ns chips, while recent revisions of the Applied GS-RAM use 120ns chips.

| | |
|---|--------|
| 256K Chip Set 150ns | \$ 69 |
| 256K Chip Set 120ns | \$ 79 |
| 256K Chip Set for RamPak & GS-Ram Ultra | \$ 59 |
| 1Mb Chip Set GS-Ram+ | \$ 359 |

Modems

| | |
|------------------------|--------|
| Applied DataLink 1200 | \$ 135 |
| Applied DataLink 2400 | \$ 175 |
| Practical 1200 SA Mini | \$ 85 |
| Practical 2400 SA | \$ 185 |
| IIGs/IIC Modem Cable | \$ 19 |

PC Transporter

| | |
|-----------------------|--------|
| PC Transporter 768K | \$ 529 |
| IIGs Installation Kit | \$ 45 |
| IIC Installation Kit | \$ 39 |
| Single 360K Drive | \$ 219 |
| Dual 360K Drive | \$ 329 |

Sound & Music

| | |
|--|--------|
| Apple MIDI Interface | \$ 79 |
| Opcode Pro Plus | \$ 92 |
| Applied Sonic Blaster | \$ 99 |
| Applied Audio Animator | \$ 179 |
| Applied Phasor | \$ 132 |
| Bose ProRoommate | |
| Speaker System | \$ 289 |
| MDIdeas Supersonic | \$ 48 |
| MDIdeas Digitizer | \$ 48 |
| Passport MIDI Interface with Drum Sync | \$ 99 |
| Passport MIDI Interface w/Tape & Drum sync | \$ 139 |

Power & Surge Protection

| | |
|---|--------|
| Applied Heavy Duty Power Supply for IIC/II+ | \$ 59 |
| EPD EC-I 6 Outlet Surge Protector | \$ 29 |
| Kensington Sys. Saver IIC | \$ 68 |
| Kensington Sys. Saver CS | \$ 77 |
| MDIdeas Conservator | \$ 99 |
| 5.25 Conservator Adapter | \$ 14 |
| Triplite 350 Watt Battery Backup | \$ 399 |

Input Devices & Joysticks

| | |
|--------------------------------|--------|
| Alturas Flight Yoke | \$ 79 |
| Apple IIC Mouse | \$ 79 |
| Apple IIC Mouse w/Card | \$ 119 |
| CH Mach II Joystick | \$ 29 |
| CH Mach III Joystick | \$ 36 |
| CH Flight Stick | \$ 48 |
| Cutting Edge ADB Kybd | \$ 149 |
| Kensington New ADB Turbo Mouse | \$ 117 |
| Kraft 3 Button Joystick | \$ 34 |
| Mouse Pad | \$ 8 |

Digitizers & Scanners

| | |
|-------------------------|--------|
| ComputerEyes IIGs | \$ 209 |
| ComputerEyes IIC or IIC | \$ 109 |
| ThunderScan | \$ 179 |

Time & Accelerators

| | |
|-----------------------|--------|
| TransWarp GS | \$ 299 |
| TransWarp Accelerator | \$ 175 |
| Timemaster II HO | \$ 77 |
| SMT No Slot Clock | \$ 39 |

Call for our low price on hundreds of popular software titles for your Apple II Computer

Write for CDA's free Apple Users' Catalog

A complete line of Apple Systems, Hardware, Software and Accessories
30-Day Customer Satisfaction Period
At CDA our goal is customer satisfaction. If you're not 100% satisfied simply return the purchased goods within 30 days of receipt for a quick, courteous refund (software, media, internal components and shipping charges excluded).

Service and Support

CDA offers a full 90 day warranty. **Apple Computers** - CDA is not an authorized Apple dealer, therefore during the 90-day warranty period Apple items must be returned to CDA for warranty repair.
Tech-support: Mon-Fri 9am-4pm, (201)832-5004.

Shipping Information and Policies

Shipping Charges - UPS Ground, add 3% (\$3.50 min); UPS Blue 2-day service, add 5% (\$5.50 min.); Alaska, Hawaii, PR, add 6% (\$6.50 min); APO/FPO shipping, add 8% (\$8.50 min). Foreign orders ship via DHL. Please call or fax for rates and more info. Payment via Visa, MC, Amex, Discover, Optima welcome. Personal checks are held 10 days for clearing. No CODs please.

US/Canada Call Toll Free 800-526-5313

NJ/Outside US 201-832-9004

CDA Computer Sales 1 CDA Plaza
Rt 513 Califon, NJ 07830

Hours: Mon-Fri 9am-10pm Sat. 9am-5pm EST
Customer Service (201) 832-9007
Fax# (201) 832-9740

Compuserve's Electronic Mall GO CDA

CDA

computer sales

Mailorder Exclusively Since 1980

Leasing now available to qualified businesses.

All prices subject to change. Apple, IIGS, & ImageWriter are registered trademarks and UniDisk is a trademark of Apple Computer Inc.



Now Apple speaks IBM. Three times faster than IBM.

**PC Transporter™,
the Apple II expansion
board that lets you run
MS-DOS programs,
now at a lower price.**

Now your Apple II can run over 10,000 programs you could never use before. Like Lotus 123, dBASE III PLUS, Symphony, Microsoft Works, even Flight Simulator.

With PC Transporter, MS-DOS programs run on your Apple II like they do on IBM PCs or compatibles. With one important difference. PC Transporter runs most of those programs *three times faster* than an IBM PC/XT.

Plus, to speed through number-crunching tasks, you can use our optional 8087-2 math co-processor chip. It plugs into a socket on the PC Transporter.

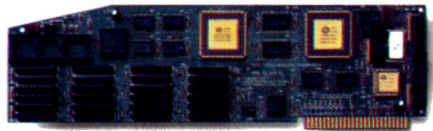

Much less expensive than an IBM clone.

PC Transporter costs less than even a stripped-down IBM clone. And when you add the host of expensive IBM-compatible peripherals you'd need to get the clone up and running, you're left with an expensive, cluttered desktop.

You don't have to buy new hardware to use PC Transporter.

Works with the hardware you already own.

With PC Transporter, MS-DOS programs actually see your Apple hardware as IBM hardware, so you can use the same hardware and peripherals you have now.

With IBM software, your Apple hardware works just like IBM hard-

ware. Disk drives, monitors, printers, printer cards, clock cards, serial cards and even hard disks look like IBM type hardware whenever the PC Transporter is activated.

You can use your IIe or IIgs keyboard with IBM software. Or use our optional IBM-style keyboard (required for the II+).

You can use your Apple mouse. Or an IBM compatible serial mouse.

Plenty of power.

PC Transporter gives you 640K of user RAM and 128K of system RAM in the IBM mode.

PC Transporter works like an Apple expansion card, adding 752K of extra RAM in the Apple mode. The 752K is useable as a RAMdisk or as memory expansion to any program that follows the Apple Memory Expansion Card protocol (most do). The Apple memory expansion alone is a \$500 value.



PC Transporter taps into the world's largest software library. Now your Apple can run most of the software you use at work. And it opens a new world of communications programs, games and bulletin boards.

Easy to install.

You can install PC Transporter in about 15 minutes, even if you've never added an expansion board. You don't need special tools. Simply plug it into an Apple expansion slot (1 through 7, except 3), connect a few cables, and go!

A universal disk drive controller.

PC Transporter will run 3.5" IBM disks from your Apple (or compatible) 3.5" drive. And even if you want to run 5.25" IBM disks you can get our versatile 5.25" drive system and still run Apple 5.25" disks from an Apple 5.25" drive. In other words, when running 3.5" disks, your Apple 3.5" drive will run *both* Apple and IBM disks.

No matter what your drives, you can shift instantly between Apple ProDOS and IBM MS-DOS.

PC Transporter supports up to 5 drives in a number of combinations.

For example, you can connect a 5.25 Applied Engineering 360K dual drive system directly to the card. Then

PC Transporter controls Apple and IBM compatible disk drives. It supports 3.5" and 5.25" MS-DOS and ProDOS formatted diskettes.



plug two daisy-chained Apple 3.5 Drives (not the old Apple UniDisk 3.5) to the dual-drive system. For a fifth drive, you can even use a ProDOS file on a hard disk as an IBM hard disk!

Versatile data storage.

You can store IBM programs and data on any ProDOS storage device including the Apple 3.5 Drive, Apple UniDisk 3.5, Apple 5.25 drive, SCSI or ProDOS compatible hard drives.

You can even use our 360K PC compatible drive for ProDOS storage and a 143K Apple 5.25 drive for MS-DOS storage.

Make your Apple speak IBM.

PC Transporter w/768K \$499

Note: 768K RAM in Apple mode translates to 640K RAM in the IBM mode because PC Transporter uses 128K for system memory.

IIgs Installation Kit \$49

IIe/II+ Installation Kit \$39

Optional 5.25 IBM Format
360K Drive Systems

Single-Drive System \$259

Dual-Drive System \$389

What the experts say:

"Gives Apple II users the best of both worlds...an impressive engineering feat." —A+

"It's ingenious...a remarkable success!" —InCider

"When you buy a PC Transporter, you're not just giving your Apple the ability to act as a PC clone, you're upgrading your computer in a big way for all your Apple II computing." —Nibble

"An excellent solution for at least half a million people who enjoy Apple II computing at home and endure MS-DOS at work." —MicroTimes

"Extremely versatile...one of the most ingenious and exciting products we've seen." —Classroom Computer Learning

"PC Transporter has created quite a stir. It's accuracy guarantees a whole host of uses...a masterpiece of engineering." —Apple Soft

*When purchased from Applied Engineering or thru a participating dealer.

Prices subject to change without notice. Brands and product names are registered trademarks of their respective holders.

Apple II+ must be FCC certified.



PC Transporter produces better IBM graphics than IBM. Analog is sharper than digital. So with a IIgs analog RGB monitor, PC Transporter's CGA graphics and text are superior to IBM's digital display—even while running your IBM Software!

Created by Apple's original designers.

The brains behind PC Transporter were also behind your Apple II.

The PC Transporter design team includes the former project managers for the creation of the Apple IIe and IIc. The co-designer of the Apple II disk controller. And the author of the ProDOS operating system.

So you know the PC Transporter and your Apple were made for each other.

Support and service from the leader in Apple add-ons.

Applied Engineering sells more Apple peripheral boards than anyone else—including Apple Computer. So you know we'll be around after the sale.

PC Transporter comes with a 15-day money back guarantee.* If you're not fully satisfied after using it, return it for a full refund. PC Transporter also comes with a 1 year warranty.

Order today!

To order or for more information, see your dealer or call (214) 241-6060 today, 9 am to 11 pm, 7 days. Or send check or money order to Applied Engineering. MasterCard, VISA and C.O.D. welcome. Texas residents add 7% sales tax. Add \$10 outside U.S.A.

AE APPLIED ENGINEERING®
The Apple enhancement experts.
P.O. Box 5100, Carrollton, TX 75011
214-241-6060
A Division of AE Research Corporation.

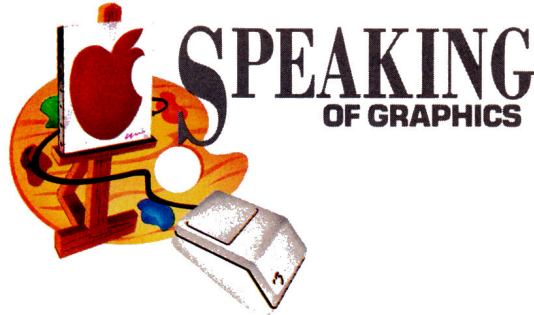

MONTAGE

Dabble! Experiment! Discover your artistic talents—and your Apple II's—with a variety of graphics tools.

By **ROBERTA SCHWARTZ**
and **MICHAEL CALLERY**

ADD A TOUCH OF BLUE, A DAB OF yellow, and you've created green. In a similar way, you can combine different features from selected programs to achieve a spectacular new effect.

Over the years we've developed a cadre of favorite software, tools that let us best do our work, whether we're teaching computer graphics or creating our own designs for educational software. We'll probably refer to these tools often in our columns, so here's a summary of the what and why.

BY DESIGN

Most educational software operates in standard (single) hi-res mode, because the majority of schools are still using Apple II Pluses and IIs. Their limited resolution (280 by 192 pixels in black-and-white and 140 by 192 in color) and restricted range of colors (white, green, purple, black, orange, and blue) make it quite a challenge to design professional-quality graphics.

To create full-page title or game screens, or windows for animation, we generally use Apple's **Designer's Toolkit**. This program, which is no longer sold, works only with the Apple Graphics Tablet, also no longer on the market. Why do we stay with a program that's discontinued and perhaps a bit outmoded? Because

it lets us do what we want to do.

Beginning students sometimes ask us why the computer can't do something. Usually, it's not the computer's limitation, but the programmer's shortsightedness. One of the developers of Designer's Toolkit is an artist, who, knowing what features other artists would want, included them in the program.

Foremost among these features is the availability of two screens on which to work, with easy cutting and pasting between them. This setup encourages us to experiment freely, knowing that if we're unhappy with our design-in-progress, we can switch instantly to the other screen containing the previous version. Two working screens also let us merge all or part of one screen with the other to create montages easily.

Designer's Toolkit also features an x-y coordinate readout. This simplifies capturing partial screens for animation and determining precisely where to place an image. With the program's slide function we can take any area of the screen and move it up, down, left, or right.

WORD AND IMAGE

One program, however, can't provide for all our drawing needs. Another program we use often is **Blazing Paddles** from Baudville. This graphics program lets us incorporate AppleSoft shapes on drawn screens easily and offers good geometric object-drawing tools.

(Designer's Toolkit doesn't draw good circles. Mathematically correct circles, when drawn on the hi-res screen, look like ovals, and the algorithm Designer's Toolkit uses fails to consider the screen's aspect ratio.) Blazing Paddles uses a "rubber band"-type tool, so that you can draw perfect circles or ovals.

For title screens or other screens with lots of type we use Data Transforms' **Fontrix**, a predecessor of today's desktop-publishing programs. Fontrix lets you work on a full 8½-by-11-inch page and integrate graphics and text easily.

Many artists have created exceptionally beautiful fonts, sold in sets as Font Paks, to use with the program. We create our screens with the paint program, then, when we need text, load the drawn screen into Fontrix and add it.

Almost every image we create, then, wends its way through at least two, and often three, programs. Just as a painter uses different tools for different purposes, we use different programs.

DAZZLE 'EM

For double-hi-res work, **Dazzle Draw** from Broderbund is our choice. Dazzle Draw was among the first drop-down-menu programs for the Apple II and remains a favorite of nearly everyone who tries it.

Dazzle Draw isn't perfect, though. Our main frustration is that you can't remove the menus and palette area from screen. Consequently, you can't work on a whole page at a time. You must remember to scroll up and down to complete a full-screen image. The typeface selection is very limited, as well, and there's only one screen to work on.

For high-quality double-hi-res type, we create our type in Fontrix and convert the screen to double-hi-res with **Beagle Graphics** from Beagle Bros or Roger Wagner's **Graphic Exchange**. Once again, using multiple ▶



Not all modems are created equal.

The right modem can change the way you use your computer. Modems allow you to step outside the limitations of your own hardware and software. But the degree to which you are benefitted by your modem is directly proportional to the quality of modem you select.

Not all modems are created equal. A new generation of 2400 baud modems, both internal and external, have appeared on the scene as of late. While Hayes AT compatibility and equivalent raw transmission speed can be expected, there are differences. Some are subtle. Others, quite significant.

Expensive features *and* low cost

Applied Engineering's entry into this market, the DataLink 2400™, was designed to combine the features of expensive modems with the price of low-cost modems.

Frankly, some of the DataLink 2400's advantages are subtle. Like the ability of our firmware to intuitively accept commands in both upper and lower case, thus avoiding the nuisance of being ignored for forgetting to press the "shift" key.

Other advantages are more evident. Like the inclusion of sophisticated, genuinely useable communications software, something others offer as an expensive option.

Hardware considerations:

While most people just plug the DataLink 2400 in and go, advanced users will find a host of sophisticated features like the ability to select firmware defaults of baud rate, data format, parity and control interrupts. Other modems require a set of obscure commands when running from firmware or don't allow you to disable interrupts.

Our DataLink 2400 has two non-volatile ROMs for pre-setting and storing different

configurations. It saves you the hassle of setting up configurations every time. We also included the ability to save phone numbers in non-volatile ROM, so you don't have to hunt for often-called numbers.

Some modems can't redirect hardware handshake lines even though most bulletin board software packages require these lines to be changeable - the DataLink 2400 can.

The software story.

We make sure you've got the right software. We include our own.

And the software we include (*OnLine 64** for the II+ and 64K IIe, *DataTerm* for the IIGS and IIe) comes thoroughly documented, *non-copy protected* on two 5.25" disks and one 3.5" disk, and positively loaded with features others don't have. Like VT52 terminal emulation, enabling you to address more bulletin boards and use them easier.

Our transfer protocols aren't limited to Xmodem. We include Xmodem, Ymodem, 4modem, ProDOS Xmodem and Turbo Xmodem. We also employ binary packing, squeezing and unsqueezing—techniques that divide, combine and compress files to save you time and long distance charges.

Some bulletin boards require different data formats. If you can't change formats you can't use them. Our software lets you change formats. Others don't.

More features:

- Full Hayes AT compatibility
- Compatible with AppleLink, Point-to-Point, ASCII Express, Access II and others
- Compatible with Bell 103 and 212, European CCITT V.22 BIS, V.22 and V.21
- Two modular jacks with long cable
- Built-in capture buffer
- Adaptive equalization and descrambling
- PC Transporter compatibility
- Macro-making program
- FCC certified design
- \$200 in free memberships, discounts and on-line time to get you started
- Proudly made in the U.S.A.

Choose an AE DataLink modem for the completeness of a total communications package, the ease of use that our step-by-step instructions assure and the reliability of our name and famous five-year warranty.

DataLink 1200* \$179
DataLink 2400 \$239

Order today!

To order or for more information, see your dealer or call (214) 241-6060 today, 9 am to 11 pm, 7 days. Or send check or money order to Applied Engineering. MasterCard, VISA and C.O.D. welcome. Texas residents add 7% sales tax. Add \$10 outside U.S.A.

AE APPLIED ENGINEERING®
The Apple enhancement experts.
A Division of AE Research Corporation.

(214) 241-6060

P.O. Box 5100, Carrollton, TX 75011

Prices subject to change without notice.

*OnLine 64 and DataLink have most, but not all the features of DataTerm and DataLink 2400 respectively.



programs lets us achieve the effect we want.

Super-hi-res offers much more powerful tools, thanks to the power of the Apple IIGS Toolkit and to the greater speed and capacity of the GS. We're evenly divided between **DeluxePaint II** from Electronic Arts and **PaintWorks Gold** from Mediagenic.

TWO PHILOSOPHIES OF COMPUTER ART

Both programs, using different basic painting philosophies, offer roughly the same set of features. In **DeluxePaint**, the primary tool is a brush—you can use any piece of the screen as that tool. **PaintWorks Gold** takes the more traditional approach with pencils, paint-brushes, spray cans, and so on.

That's not to say there's no crossover—you can use the smallest single-pixel brush in **DeluxePaint** to achieve the pencil effect, and you can use a selected area of the screen as a brush in **PaintWorks Gold**.

PaintWorks Gold has the better interface. It looks and works according to Apple's guidelines, while **DeluxePaint II** depends on hard-to-remember keyboard commands.

Fair warning, though—**PaintWorks Gold** is a memory hog and isn't GS/OS friendly. If you've read this far, you can probably guess that we create many images in both programs, utilizing the features we like in each.

For those of you who want to work in all three graphics modes without investing in lots of software, we recommend Baudville's **816/Paint**. This one package offers three paint programs: standard-hi-res, double-hi-res, and super-hi-res. Something for everyone!

SHAPING UP

In addition to painting, we've also done a fair amount of Applesoft shape-table work in our commercial projects.

Two programs stand out: Beagle Bros' **Shape Mechanic** lets us capture pieces of a drawn screen into a shape table; **Pixit** from Baudville lets us rearrange and fine-tune the table.

In commercial software, most animation is accomplished via proprietary routines. When you're using a package, Polarware's **Graphics Magician** and Baudville's **Take One** have the lead.

Graphics Magician offers two types of graphics: block-shape routines suitable for animating game pieces and picture-object routines suitable for creating "painted"-style graphics.

PRODUCT INFORMATION

Animation Toolkit, \$60
Blazing Paddles, \$34.95
816/Paint, \$75
Pixit, \$34.95
Take One, \$59.95
Baudville
53820 52nd Street S.E.
Grand Rapids, MI 49512
(616) 698-0888

Beagle Graphics, \$30
Shape Mechanic, \$20
Beagle Bros
6215 Ferris Square
Suite 100
San Diego, CA 92121
(800) 345-1750
(619) 452-5500

Dazzle Draw
Broderbund Software
17 Paul Drive
San Rafael, CA 94903-2101
(800) 527-6263
(415) 592-3500
\$59.95

DeluxePaint II
Electronic Arts
1820 Gateway Drive
San Mateo, CA 94404
(415) 572-2787
(800) 245-2526
\$99

Dover Publications
180 Varick Street
New York, NY 10014
(212) 255-3755

Fontrix
Data Transforms
616 Washington Street
Denver, CO 80203
(303) 832-1501
\$95

Graphic Exchange
Roger Wagner Publishing
1050 Pioneer Way
Suite P
El Cajon, CA 92020
(619) 442-0524
\$49.95

Graphics Magician
Polarware
1055 Paramount Parkway
Suite A
Batavia, IL 60510
(800) 323-0884
(312) 232-1984
\$49.95

PaintWorks Gold
Mediagenic
3885 Bohannon Drive
Menlo Park, CA 94025
(415) 329-0800
\$99.95

Picture-object routines, which save the moves you make in creating a graphic rather than the graphic itself, re-creates your image step by step, before your eyes. Many adventure-game programs use these routines, because they provide compact storage.

A full-screen image created with picture-object routines can be as small as one disk sector or block rather than the usual 33 sectors or 17 blocks, which a standard-hi-res image takes up. **Take One** uses a traditional block-shape approach and, combined with Baudville's **Animation Toolkit**, enables Applesoft BASIC programmers to integrate animation into their programs easily.

While these are the programs we favor, there are lots of other good Apple II graphics programs; we'll take a look at some of them in future columns.

OUTSTANDING GRAPHICS: TIPS FOR PROS AND NOVICES

Among our colleagues, our students, and you, our readers, we see a lot of Apple II

graphics. Some have a professional quality others lack. What's the difference? Can you emulate it?

Of course, experience and talent play a significant part. The computer can't make up for lack of skill; it's only a tool. There are ways to achieve superior results, though, even if you're just learning.

1. Use source art. Even professional artists use models, photographs, and other reference material.

If you want to draw a cat the best thing to do is to look at cats; study them walking, sleeping, running, sitting, and so on.

Second to studying the real thing is to refer to pictures. Get lots of pictures of cats and study them.

Dover clip-art books are excellent sources of images. Be careful, though—don't copy a copyrighted image. The image should be a only a springboard for your creative interpretation.

2. Pay attention to detail. With limited reso-

lution (even in super-hi-res mode, you have only 64,000 pixels to work with) every dot counts.

All graphics programs worth owning have a magnification (or "zoom") mode. Overall we probably spend more time in zoom mode than standard.

Look especially at edges. In single-hi-res mode, you can use outlines of white or black to clarify and smooth jagged edges.

In double-hi-res and especially in super-hi-res mode, you can take advantage of extended palettes to make edges look smoother. (For example, you can soften dark-blue edges against a white background by bordering them with light blue).

3. Be aware of color idiosyncrasies, especially in standard-hi-res mode. Because of the way color works in this mode, you can't, for example, place orange next to violet just anywhere on screen; placing an orange pixel in a violet area will flip some of the violet pixels to blue.

Other combinations create similar problems. Unresolved color problems clearly identify amateur work.

4. Refine your work. Eliminate stray pixels, clean up overly jagged lines, correct color problems, and so on.

In the hit play *Sunday in the Park with George*, Seurat declares, "Art isn't easy." That's an understatement. With a little time, a lot of care, and attention to detail, though, you can create stand-out graphics on your Apple II.

WE BEGIN ANEW:

CORRESPONDING WITH OUR READERS

We'd love to hear from you—our new readers as well as our old.

Please write and tell us what you'd like us to discuss in future columns. Let us know how you're using graphics on your Apple II.

Are you beginners, experienced artists, professionals? What are your favorite programs? Do you have any graphics tips you'd like to share with other readers? We look forward to hearing from you. See you next time! □

ROBERTA SCHWARTZ AND MICHAEL CALLERY TEACH COMPUTER GRAPHICS AND DESKTOP PUBLISHING AT THE NEW SCHOOL FOR SOCIAL RESEARCH IN NEW YORK AND CREATE GRAPHICS FOR COMMERCIAL SOFTWARE. WRITE TO THEM C/O INCIDER, 80 ELM STREET, PETERBOROUGH, NH 03458.

QUICK CHANGE ARTIST.

You want to put works of art into your Apple®. Without lots of work. So you go to your ImageWriter®. Pop out the ribbon cartridge. Snap in ThunderScan®. Insert your artwork. And quicker than you can say Van Gogh, you're already going.

Turn your ImageWriter into a powerful image scanner. ThunderScan lets you put crisp images into most paint, drawing and desktop publishing programs. Change contrast and brightness with true gray scale. Colorize on screen and paper. Print out in three different styles.

Priced at just \$219, ThunderScan proves you can become an artist, with just a little change.

When your image really matters.



ThunderScan®
for Apple® II

21 Orinda Way, Orinda, CA 94563
415/254-6581 FAX: 415/254-3047

ThunderScan is compatible with all IIGs, IIE, and IIC models and all ImageWriter models except the I.Q. Images can be saved in high, double high and super res formats. The following are trademarks of the companies indicated: Apple and ImageWriter: Apple Computer, Inc.; ThunderScan, Thunderware and its logo: Thunderware, Inc. ©1989 Thunderware, Inc.



GEOMETRY

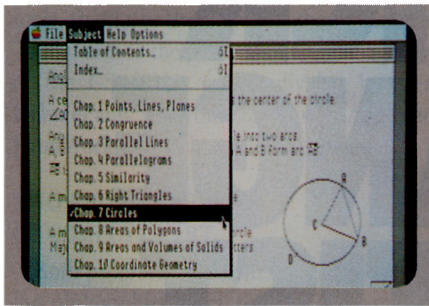

BRODERBUND SOFTWARE,
17 Paul Drive, San Rafael, CA 94903, (800)
527-8263, (415) 492-3500

Geometry-education program; 512K Apple IIGS;
\$79.95

Rating: ◆ ◆ ◆ ◆

Just think where mathematics would be today if Euclid and Pythagoras had had a computer and a program like Geometry to play with.

With Geometry, you can see the angles of a triangle change as you move one of its vertices; you can compare the slope formulae for a line as you drag its points about the screen. With a tool like this, you can master trapezoids and rhombuses, even if you aren't a master mathematician.

GET TO THE POINT

Geometry spans the subject, from points, lines, and planes through the formulae for areas of polygons and the areas and volumes of solids. It also introduces analytic geometry from the Cartesian coordinate system through the slope-intercept formula for a line and the theorems relating slope to the concepts of parallelism and perpendicularity. If you aren't a math teacher, that means the package covers the same topics as most high-school geometry courses.

You might describe the course format as a living textbook. It has ten chapters—five each on two disks—with a third disk containing startup and printer-driver files. Because Geometry runs only on the GS, it uses the desktop format and supports mouse input.

Once you launch the program, you'll see the title page, complete with pull-down menus. From there you can select any of the five chapters on the current disk. You won't have to page through a chapter to find specific topics, though. From the pull-down menu, you can select a table of contents, which enumerates

the material in each chapter or gives you a comprehensive index of the entire "book." Click on any topic and let your disk drive do the searching.

Once you've selected a subject, you'll see a page that at first appears much like an old-fashioned geometry book—lots of text with definitions of terms such as *parallel* and *equilateral*, and some simple drawings of lines and triangles.

But as all geometry students know, apparent similarity can be misleading. Just click on a definition and the skew lines lounging to one side of the screen suddenly stand at attention, parallel to a point. Click on another page and a scalene triangle reconnoiters its vertices to become equilateral. Try that with your high-school textbook.

Turn another page and you can see a theorem, a line drawing illustrating it, and the word *Proof*. Click on *Proof* to paste an overlay onto the screen. If you want, you can even print the proof.

Suppose you don't believe, though, that the sum of the interior angles of a polygon equals the number of sides minus two times 180 degrees—no matter what the proof says. Just close the proof window and click on the illustration to see for yourself. The polygon transmutes from a hexagon made up of four triangles to a heptagon made up of five triangles to an octagon made up of six triangles and keeps going for about as far as you can distinguish on a double-hi-res screen.

Finally convinced, you turn the page. These items look like the math problems we all know and love. But these problems don't test you for the sake of keeping score—they ensure you can apply what you've just learned. Suppose you've just studied the slope-intercept equation. An x-y axis appears on screen with a line segment and the equation $y = x + 3$. A table below the equation offers some possible values for x and y and asks you to fill in the rest.

If you've forgotten how already, just ask for a Reference from the pull-down menu, and the page on which the concepts were presented will overlay the problem page. You can review the tutorial section until you're certain you understand the material. Then close the Reference to return to the problem.

Do you need a hint? Call Help from the pull-down menu. Are you totally stymied? There's a Solution option, but why use it? By experimenting, you can discover the answer to most problems even if you're baffled at first.

The program will ultimately tell you whether your answer is right or wrong.

There are other ways to use Geometry, too. You can select just the tutorial or just the problems, for instance. If you're only reviewing, set the system to problem-only mode to see how much of the material you've already mastered. When you run into a problem you can't solve, opt for a Reference and page through that section of the tutorial.

GREAT EXPECTATIONS

Geometry is a program I've been looking forward to since it was announced in 1985—someone had finally applied the power of the computer toward helping students visualize a subject in a way never before possible. The GS version promised to be even more exciting. In many ways, Geometry has lived up to my expectations, but of course there are limitations to every program.

Launching is slow. If you run Geometry from one 3½-inch drive, you'll do a fair amount of disk swapping. These are minor inconveniences, however, compared to the delays you face if you use the index extensively to leap from topic to topic. Every time you want to jump from a concept in the first half of the "book" to one in the second half, you have to quit and restart the entire program. If you use the material chapter by chapter, however, you won't suffer much from this flaw.

On the content side, Geometry is the "Reader's Digest Condensed Version" of the subject. No teacher would want to introduce students to geometry without discussing the way Euclid's work in 300 B.C. built on the discoveries of earlier peoples and how later mathematicians built on the work of the Greeks.

And nowhere does Geometry suggest that there's the slightest practical application for the material it teaches. Nor does it lure anyone to the contemplation of the beauty of the concepts and relationships it presents. In fact, you can solve many of the problems correctly by simple substitution and mimicry, without an understanding of the underlying theorems.

Still, like drill-and-practice arithmetic software, Geometry serves a useful function—and it's a lot more fun than a standard workbook. Whether you need to pass a test, teach a class, or just do a few mental push-ups with the right hemisphere of your brain, Geometry's an enjoyable way to do it.

Jeanne Dietsch
Peterborough, NH

MAP SKILLS

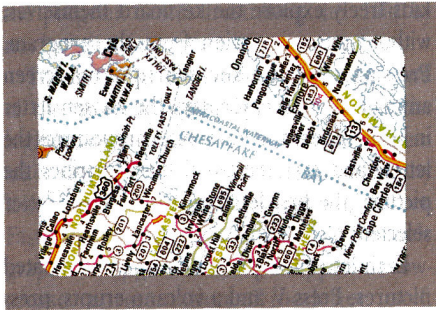

**OPTIMUM RESOURCE,
10 Station Place, Norfolk, CT 06058, (800)
327-1473, (203) 542-5553**

Map-reading program; 48K Apple IIs, available
on 5¼- or 3½-inch disk; \$49.95

Rating: ♦ ♦ ♦

Daddy, are we there yet?" Weekly Reader (Optimum Resource) comes to the rescue of family vacationers all across the USA, with a new program that invites children to sharpen their map-reading abilities by "driving" their way through five different communities. You can't take it with you, but at least you won't get lost.

WHICH WAY?

Children can take as many as 100 trips through Map Skills' ten levels of difficulty. The object is to reach the assigned destination quickly, following travel directions as closely as possible to navigate the most direct route. A child may play alone or compete with a friend; when kids complete an exercise successfully, they move up automatically to the next level.

The package includes two paper versions of the program's five travel maps—Vista Del Mar, Sherman County, East Warwick, Puffin Island, and Goose Bay. One is a colorful full-detail poster showing all five communities. The other consists of five smaller black-line master maps, suitable for copying and distribution to students.

Each map contains a legend with an accurate scale showing distance in inches and miles (such as 1 inch = 14 miles or 1 inch = ½ mile). There's also a key explaining the symbols used to indicate interstate, primary, and secondary roads, plus a directional compass for orientation. Road numbers are clearly marked on all maps. City, town, and place names appear on the paper maps, but not on their screen versions.

At the beginning of each game, players receive their travel instructions. For example, one trip may require the driver to travel in East Warwick en route to Tiger Stadium (the football field). The directions may ask you to start from the Carlson School on 32nd Street; then take 32nd Street north to 4th Avenue to 40th Street; turn north at 40th Street and stay on that until 10th Avenue.

Another trip may involve driving the following route on a map of Vista Del Mar: From Pelican Island at the eastern end of Route 18, go home to Sierra at the junction of Route 72 and Route 9. Take Route 18 west all the way to Route 15 north, then Route 68 west and Route 9 north to Route 72.

LOST IN SUBURBIA

At higher levels, the travel instructions become pretty cryptic. For example, the game may tell players to go north, right, north, right, left, north, right, straight, south, left, straight, east, south, left, straight, east, south, south, left to Pine. Students may have to try several different routes to achieve their best time and lowest mileage.

Directions incorporate route, street, and road numbers, place names, and left or right turns, in addition to standard compass directions. The compass at the bottom of the screen doesn't change direction as players drive, but it's helpful for reference.

Map coordinates aren't included for either the screen or paper versions. Students must track down the starting position by reviewing the entire map, instead of looking it up in an indexed legend.

START YOUR ENGINES

During game play, drivers may toggle between the driving screen and the instructions, but Weekly Reader suggests taking a few notes to save driving time.

After reading the instructions, students can press any key to start the clock. The car becomes a flashing rectangular cursor on the map. Children maneuver the vehicle by pressing the arrow or I, J, K, M keys to drive in the appropriate direction—up for north, down for south, left for west, and right for east.

The vehicle stops at every intersection, so players must think about their next move before pressing a directional key to keep going. A magnified version of the intersection appears on the "dashboard" at the bottom of the

screen. Magnification mode comes in handy while manipulating the vehicle around jags in the road or making a decision about which way to travel.

When players take a wrong turn, they'll hear an error buzz. If this happens, they should study the car's position in magnification mode and make the necessary corrections to get back on the right track.

As the vehicle proceeds along the map, gauges on the dashboard at the bottom of the screen mark the distance traveled in miles and indicate current travel time. Players will know they've reached the correct destination when they hear a round of musical reinforcement. The program will then present a report screen with information about distance traveled and time taken, as well as best distance and time achieved by the people at Weekly Reader. Students may then repeat the exercise or opt for a new assignment.

BLAZING YOUR OWN TRAIL

Map Skills also includes a customizing feature. You can tailor the program options to meet the needs of individual students when you first load the game. Pressing Control-C at the title screen lets you enter the name of a specific student, select a difficulty level (1-11) for the exercises, and choose which maps the student will navigate. Level 11 contains the exercises you've designed. You may also specify any combination of maps to be included in an exercise.

Pressing Control-R at the title screen calls up the Report Card option. Reports indicate starting level, current exercise level, number of exercises attempted, and number of exercises completed for every student on the list. You can check a student's report card, delete a record, or look at options chosen for each student. You can also print an individual's report card.

Map Skills lets you create your own travel exercises by pressing Control-A at the title screen. You can add up to eight trips per map, for a total of 40 exercises. Once you add an exercise, you can print it or delete it to make room for new ones.

CHART YOUR COURSE

The first task in setting up a personalized trip is to choose a map. The program will then ask you to select starting and end points. For memory reasons, Map Skills allows only a limited number of locations to serve as starting ▶

REVIEWS

and ending points. All of these are displayed in the accompanying *User's Guide*.

After selecting an end point, you must name the trip, type in travel directions, and set goals for optimum time and distance. To obtain information on time and mileage, you should navigate the route on screen yourself, using the appropriate map. You might also consider letting children devise their own travel exercises, as a way of giving them additional opportunities to reinforce their map-reading aptitude.

WHERE THE HECKAWE?

If your kids seem about as discombobulated as the folks of *F Troop*, Map Skills may be the answer. It's easy to play; and while the graphics may be repetitive, the program is an entertaining simulation.

To be successful, students must translate traditional map symbols such as direction (north, south, east, and west) and route numbers into visual guides. The program's customizing feature also increases its usefulness in the classroom or home, because it lets youngsters strengthen their map-reading skills by giving directions to others. It teaches children how to navigate simple routes, gives them an understanding of the concept of relative position, and above all helps them learn to read maps with confidence.

Carol S. Holzberg, Ph.D.
Shutesbury, MA

TALKING STICKYBEAR ALPHABET



OPTIMUM RESOURCE,
10 Station Place, Norfolk, CT 06058, (800)
327-1473, (203) 542-5553
Alphabet and beginning word recognition: 512K
Apple IIGS, 3½-inch drive; \$49.95
Rating: ♦ ♦ ♦ ♦

Although Stickybear Alphabet has been around in one form or another for quite some time, the continual demand for this program is proof of its excellence. Now Apple IIGS owners can enchant and educate their youngsters with an all-new version of this best seller—Talking Stickybear Alphabet.

Talking Stickybear Alphabet lets a child select from three basic activities, all intended to aid him or her in learning the alphabet and recognizing simple words.

The first item on the menu is called, appropriately enough, Alphabet. This activity lets kids freely explore the keyboard themselves, without any instruction from the program. Pressing any letter key calls up a full-screen animated graphic, displays the chosen letter in both upper- and lowercase, pronounces the letter, and says the word that describes the picture (the first letter of which is the letter selected, of course).

Each letter is represented by two animated pictures. Press V and a volcano erupts; press V again and a violin begins to play. Each action will repeat itself until you interrupt it by pressing another key.

The second activity is called Letter Hunt, a step up the learning scale. Here a full-screen image of Bedford Stickybear instructs the child to press a specific letter. Pressing the correct letter makes the program show an appropriate graphic and pronounce the letter. Should the child make a wrong choice, the sensitive Stickybear displays and pronounces the correct letter, saying, for example, "This is B. Press the letter B," to give the child a second chance. If he or she makes another mistake, the program simply moves on to another random letter.

Letter Hunt employs two effective teaching methods. To begin with, the child is given two chances with strong verbal and visual hints in between to increase his or her chance of success. Then, in the event of another mistake on the child's part, the program downplays the



1-800-544-7638
Inquiries & Oregon buyers
1-503-246-0924

**SCHOOLS
OUR
SPECIALTY**

| | | | | | | | | | | | | | | | | | | | | | | | | | | | | | | | | | | | | | | | | | | | | | | | | | | | | | | | | | | | | | | | | | | | | | | | | | | | | | | | | | | | | | | | | | | | | | | | | |
|--|-----------------------------|--|--|-----------------------------------|--------|--------|-----------------------------------|--------|--------|---|--------|--------|--|--------|--------|--------------------------------------|--------|--------|---|--------|--------|---------------------------------------|--------|--------|--------------------------------------|--------|---------|---|--------|---------|--|--------|--------|--------------------------------------|--------|--------|------------------------------|--------|--------|--------------------------------|--------|--------|--|--------|--------|---|--------|---------|---|--------|--------|--|--------|---------|--------------------------------------|--------|--------|-------------------------------------|--------|--------|---|--------|--------|--------------------------------------|---------|---------|---|--------|---------|--------------------------------------|--------|---------|---|--------|--------|-----------------------------------|--------|--------|-----------------------------------|--------|---------|---|--------|---------|---|--------|---------|---|--------|--------|--|---------------------|---------|-----------------------|---------|---|
| CABLES, All cables have a 5 YEAR WARRANTY | | <p>VSI was founded in 1984 and has since become a leader in the field of cables and switching devices. We are dedicated to provide top value and quality on a budget. School districts large and small are a specialty of our firm. Complete catalog on request.</p> | <table border="0" style="width: 100%; border-collapse: collapse;"> <tr> <td>Apple IIGS to ImageWriter I</td> <td>A303GS</td> <td>\$9.95</td> </tr> <tr> <td>Apple IIGS to Laser Writer</td> <td>A304GS</td> <td>\$9.95</td> </tr> <tr> <td>Apple IIGS to ImageWriterII</td> <td>A305GS</td> <td>\$9.95</td> </tr> <tr> <td>Laser 128 to ImageWriter II</td> <td>A308BI</td> <td>\$9.95</td> </tr> <tr> <td>Laser 128 to ImageWriter LQ</td> <td>A308BO</td> <td>\$9.95</td> </tr> <tr> <td>Laser 128 to Apple Personal Modem</td> <td>A308AM</td> <td>\$9.95</td> </tr> <tr> <td>8 Pin Mini Din, male/male, 6 ft</td> <td>ABMM6</td> <td>\$9.95</td> </tr> <tr> <td>8 Pin Mini Din Extension, 6 ft</td> <td>ABE6</td> <td>\$10.95</td> </tr> <tr> <td>8 Pin Mini Din Extension, 10 ft</td> <td>ABE10</td> <td>\$14.95</td> </tr> <tr> <td>DB9, 12ft., Joystick Extension</td> <td>JS12</td> <td>\$4.95</td> </tr> <tr> <td>DB9, Y cable, 1 female/ 2 male</td> <td>JSY</td> <td>\$6.95</td> </tr> <tr> <td>DB9, 6 ft., male/male</td> <td>DB9MM</td> <td>\$8.95</td> </tr> <tr> <td>DB9, 6 ft., Extension</td> <td>DB9MF</td> <td>\$8.95</td> </tr> <tr> <td>Parallel, 36 Pin, 6 ft., male/male</td> <td>C6MM</td> <td>\$9.95</td> </tr> <tr> <td>Parallel, 36 Pin, 10 ft., male/male</td> <td>C10MM</td> <td>\$11.95</td> </tr> <tr> <td>Parallel, 36 Pin, 6 ft., male/fem</td> <td>C6MF</td> <td>\$9.95</td> </tr> <tr> <td>Parallel, 36 Pin, 10 ft., male/fem</td> <td>C10MF</td> <td>\$11.95</td> </tr> <tr> <td>Serial, DB25, 6 ft., male/male</td> <td>R6MM</td> <td>\$8.95</td> </tr> <tr> <td>Serial, DB25, 6 ft., male/fem</td> <td>R6MF</td> <td>\$8.95</td> </tr> <tr> <td>IBM Printer, 6 ft., male/male</td> <td>IBP6</td> <td>\$8.95</td> </tr> <tr> <td>IBM Printer, 10 ft., male/male</td> <td>IBP10</td> <td>\$10.95</td> </tr> <tr> <td>IBM Printer, 15 ft., male/male</td> <td>IBP15</td> <td>\$16.95</td> </tr> <tr> <td>IBM Printer, 25 ft., male/male</td> <td>IBP25</td> <td>\$24.95</td> </tr> <tr> <td>IMB Keyboard Extension, 5 Pin, 5 ft.</td> <td>IBKE</td> <td>\$5.95</td> </tr> <tr> <td>Power Cable, male</td> <td>PR6</td> <td>\$3.95</td> </tr> <tr> <td>IIe Numerical Key Pad</td> <td></td> <td>\$29.95</td> </tr> <tr> <td>II, Iie Cooling Fan</td> <td></td> <td>\$29.95</td> </tr> <tr> <td>Power Command Center</td> <td></td> <td>\$49.95</td> </tr> <tr> <td>Disk Notcher</td> <td></td> <td>\$4.49</td> </tr> </table> | Apple IIGS to ImageWriter I | A303GS | \$9.95 | Apple IIGS to Laser Writer | A304GS | \$9.95 | Apple IIGS to ImageWriterII | A305GS | \$9.95 | Laser 128 to ImageWriter II | A308BI | \$9.95 | Laser 128 to ImageWriter LQ | A308BO | \$9.95 | Laser 128 to Apple Personal Modem | A308AM | \$9.95 | 8 Pin Mini Din, male/male, 6 ft | ABMM6 | \$9.95 | 8 Pin Mini Din Extension, 6 ft | ABE6 | \$10.95 | 8 Pin Mini Din Extension, 10 ft | ABE10 | \$14.95 | DB9, 12ft., Joystick Extension | JS12 | \$4.95 | DB9, Y cable, 1 female/ 2 male | JSY | \$6.95 | DB9, 6 ft., male/male | DB9MM | \$8.95 | DB9, 6 ft., Extension | DB9MF | \$8.95 | Parallel, 36 Pin, 6 ft., male/male | C6MM | \$9.95 | Parallel, 36 Pin, 10 ft., male/male | C10MM | \$11.95 | Parallel, 36 Pin, 6 ft., male/fem | C6MF | \$9.95 | Parallel, 36 Pin, 10 ft., male/fem | C10MF | \$11.95 | Serial, DB25, 6 ft., male/male | R6MM | \$8.95 | Serial, DB25, 6 ft., male/fem | R6MF | \$8.95 | IBM Printer, 6 ft., male/male | IBP6 | \$8.95 | IBM Printer, 10 ft., male/male | IBP10 | \$10.95 | IBM Printer, 15 ft., male/male | IBP15 | \$16.95 | IBM Printer, 25 ft., male/male | IBP25 | \$24.95 | IMB Keyboard Extension, 5 Pin, 5 ft. | IBKE | \$5.95 | Power Cable, male | PR6 | \$3.95 | IIe Numerical Key Pad | | \$29.95 | II, Iie Cooling Fan | | \$29.95 | Power Command Center | | \$49.95 | Disk Notcher | | \$4.49 | | | | | | |
| Apple IIGS to ImageWriter I | A303GS | | | \$9.95 | | | | | | | | | | | | | | | | | | | | | | | | | | | | | | | | | | | | | | | | | | | | | | | | | | | | | | | | | | | | | | | | | | | | | | | | | | | | | | | | | | | | | | | | | | | | |
| Apple IIGS to Laser Writer | A304GS | \$9.95 | | | | | | | | | | | | | | | | | | | | | | | | | | | | | | | | | | | | | | | | | | | | | | | | | | | | | | | | | | | | | | | | | | | | | | | | | | | | | | | | | | | | | | | | | | | | | | |
| Apple IIGS to ImageWriterII | A305GS | \$9.95 | | | | | | | | | | | | | | | | | | | | | | | | | | | | | | | | | | | | | | | | | | | | | | | | | | | | | | | | | | | | | | | | | | | | | | | | | | | | | | | | | | | | | | | | | | | | | | |
| Laser 128 to ImageWriter II | A308BI | \$9.95 | | | | | | | | | | | | | | | | | | | | | | | | | | | | | | | | | | | | | | | | | | | | | | | | | | | | | | | | | | | | | | | | | | | | | | | | | | | | | | | | | | | | | | | | | | | | | | |
| Laser 128 to ImageWriter LQ | A308BO | \$9.95 | | | | | | | | | | | | | | | | | | | | | | | | | | | | | | | | | | | | | | | | | | | | | | | | | | | | | | | | | | | | | | | | | | | | | | | | | | | | | | | | | | | | | | | | | | | | | | |
| Laser 128 to Apple Personal Modem | A308AM | \$9.95 | | | | | | | | | | | | | | | | | | | | | | | | | | | | | | | | | | | | | | | | | | | | | | | | | | | | | | | | | | | | | | | | | | | | | | | | | | | | | | | | | | | | | | | | | | | | | | |
| 8 Pin Mini Din, male/male, 6 ft | ABMM6 | \$9.95 | | | | | | | | | | | | | | | | | | | | | | | | | | | | | | | | | | | | | | | | | | | | | | | | | | | | | | | | | | | | | | | | | | | | | | | | | | | | | | | | | | | | | | | | | | | | | | |
| 8 Pin Mini Din Extension, 6 ft | ABE6 | \$10.95 | | | | | | | | | | | | | | | | | | | | | | | | | | | | | | | | | | | | | | | | | | | | | | | | | | | | | | | | | | | | | | | | | | | | | | | | | | | | | | | | | | | | | | | | | | | | | | |
| 8 Pin Mini Din Extension, 10 ft | ABE10 | \$14.95 | | | | | | | | | | | | | | | | | | | | | | | | | | | | | | | | | | | | | | | | | | | | | | | | | | | | | | | | | | | | | | | | | | | | | | | | | | | | | | | | | | | | | | | | | | | | | | |
| DB9, 12ft., Joystick Extension | JS12 | \$4.95 | | | | | | | | | | | | | | | | | | | | | | | | | | | | | | | | | | | | | | | | | | | | | | | | | | | | | | | | | | | | | | | | | | | | | | | | | | | | | | | | | | | | | | | | | | | | | | |
| DB9, Y cable, 1 female/ 2 male | JSY | \$6.95 | | | | | | | | | | | | | | | | | | | | | | | | | | | | | | | | | | | | | | | | | | | | | | | | | | | | | | | | | | | | | | | | | | | | | | | | | | | | | | | | | | | | | | | | | | | | | | |
| DB9, 6 ft., male/male | DB9MM | \$8.95 | | | | | | | | | | | | | | | | | | | | | | | | | | | | | | | | | | | | | | | | | | | | | | | | | | | | | | | | | | | | | | | | | | | | | | | | | | | | | | | | | | | | | | | | | | | | | | |
| DB9, 6 ft., Extension | DB9MF | \$8.95 | | | | | | | | | | | | | | | | | | | | | | | | | | | | | | | | | | | | | | | | | | | | | | | | | | | | | | | | | | | | | | | | | | | | | | | | | | | | | | | | | | | | | | | | | | | | | | |
| Parallel, 36 Pin, 6 ft., male/male | C6MM | \$9.95 | | | | | | | | | | | | | | | | | | | | | | | | | | | | | | | | | | | | | | | | | | | | | | | | | | | | | | | | | | | | | | | | | | | | | | | | | | | | | | | | | | | | | | | | | | | | | | |
| Parallel, 36 Pin, 10 ft., male/male | C10MM | \$11.95 | | | | | | | | | | | | | | | | | | | | | | | | | | | | | | | | | | | | | | | | | | | | | | | | | | | | | | | | | | | | | | | | | | | | | | | | | | | | | | | | | | | | | | | | | | | | | | |
| Parallel, 36 Pin, 6 ft., male/fem | C6MF | \$9.95 | | | | | | | | | | | | | | | | | | | | | | | | | | | | | | | | | | | | | | | | | | | | | | | | | | | | | | | | | | | | | | | | | | | | | | | | | | | | | | | | | | | | | | | | | | | | | | |
| Parallel, 36 Pin, 10 ft., male/fem | C10MF | \$11.95 | | | | | | | | | | | | | | | | | | | | | | | | | | | | | | | | | | | | | | | | | | | | | | | | | | | | | | | | | | | | | | | | | | | | | | | | | | | | | | | | | | | | | | | | | | | | | | |
| Serial, DB25, 6 ft., male/male | R6MM | \$8.95 | | | | | | | | | | | | | | | | | | | | | | | | | | | | | | | | | | | | | | | | | | | | | | | | | | | | | | | | | | | | | | | | | | | | | | | | | | | | | | | | | | | | | | | | | | | | | | |
| Serial, DB25, 6 ft., male/fem | R6MF | \$8.95 | | | | | | | | | | | | | | | | | | | | | | | | | | | | | | | | | | | | | | | | | | | | | | | | | | | | | | | | | | | | | | | | | | | | | | | | | | | | | | | | | | | | | | | | | | | | | | |
| IBM Printer, 6 ft., male/male | IBP6 | \$8.95 | | | | | | | | | | | | | | | | | | | | | | | | | | | | | | | | | | | | | | | | | | | | | | | | | | | | | | | | | | | | | | | | | | | | | | | | | | | | | | | | | | | | | | | | | | | | | | |
| IBM Printer, 10 ft., male/male | IBP10 | \$10.95 | | | | | | | | | | | | | | | | | | | | | | | | | | | | | | | | | | | | | | | | | | | | | | | | | | | | | | | | | | | | | | | | | | | | | | | | | | | | | | | | | | | | | | | | | | | | | | |
| IBM Printer, 15 ft., male/male | IBP15 | \$16.95 | | | | | | | | | | | | | | | | | | | | | | | | | | | | | | | | | | | | | | | | | | | | | | | | | | | | | | | | | | | | | | | | | | | | | | | | | | | | | | | | | | | | | | | | | | | | | | |
| IBM Printer, 25 ft., male/male | IBP25 | \$24.95 | | | | | | | | | | | | | | | | | | | | | | | | | | | | | | | | | | | | | | | | | | | | | | | | | | | | | | | | | | | | | | | | | | | | | | | | | | | | | | | | | | | | | | | | | | | | | | |
| IMB Keyboard Extension, 5 Pin, 5 ft. | IBKE | \$5.95 | | | | | | | | | | | | | | | | | | | | | | | | | | | | | | | | | | | | | | | | | | | | | | | | | | | | | | | | | | | | | | | | | | | | | | | | | | | | | | | | | | | | | | | | | | | | | | |
| Power Cable, male | PR6 | \$3.95 | | | | | | | | | | | | | | | | | | | | | | | | | | | | | | | | | | | | | | | | | | | | | | | | | | | | | | | | | | | | | | | | | | | | | | | | | | | | | | | | | | | | | | | | | | | | | | |
| IIe Numerical Key Pad | | \$29.95 | | | | | | | | | | | | | | | | | | | | | | | | | | | | | | | | | | | | | | | | | | | | | | | | | | | | | | | | | | | | | | | | | | | | | | | | | | | | | | | | | | | | | | | | | | | | | | |
| II, Iie Cooling Fan | | \$29.95 | | | | | | | | | | | | | | | | | | | | | | | | | | | | | | | | | | | | | | | | | | | | | | | | | | | | | | | | | | | | | | | | | | | | | | | | | | | | | | | | | | | | | | | | | | | | | | |
| Power Command Center | | \$49.95 | | | | | | | | | | | | | | | | | | | | | | | | | | | | | | | | | | | | | | | | | | | | | | | | | | | | | | | | | | | | | | | | | | | | | | | | | | | | | | | | | | | | | | | | | | | | | | |
| Disk Notcher | | \$4.49 | | | | | | | | | | | | | | | | | | | | | | | | | | | | | | | | | | | | | | | | | | | | | | | | | | | | | | | | | | | | | | | | | | | | | | | | | | | | | | | | | | | | | | | | | | | | | | |
| <table border="0" style="width: 100%; border-collapse: collapse;"> <tr> <td>Mac to ImageWriter II</td> <td>A306II</td> <td>\$9.95</td> </tr> <tr> <td>Mac to ImageWriter LQ</td> <td>A306LQ</td> <td>\$9.95</td> </tr> <tr> <td>Mac to Apple Personal Modem</td> <td>A306PM</td> <td>\$9.95</td> </tr> <tr> <td>Mac to Hayes Modem, 300/1200/2400</td> <td>A203MM</td> <td>\$9.95</td> </tr> <tr> <td>Mac+, 8 Pin Mini F/DB9 F Adaptor</td> <td>A101M+</td> <td>\$9.95</td> </tr> <tr> <td>Mac+ to Hayes Compatible Modem</td> <td>A202M+</td> <td>\$9.95</td> </tr> <tr> <td>Mac+ to ImageWriter I</td> <td>A303M+</td> <td>\$9.95</td> </tr> <tr> <td>Mac+ to Laser Writer</td> <td>A304M+</td> <td>\$9.95</td> </tr> <tr> <td>Mac+ to ImageWriter II</td> <td>A305M+</td> <td>\$9.95</td> </tr> <tr> <td>Mac SE 8 Pin Mini F/DB9 F Adaptor</td> <td>A101SE</td> <td>\$9.95</td> </tr> <tr> <td>Mac SE to Hayes Compatible Modem</td> <td>A202SE</td> <td>\$9.95</td> </tr> <tr> <td>Mac SE to ImageWriter I</td> <td>A303SE</td> <td>\$9.95</td> </tr> <tr> <td>Mac SE to Laser Writer</td> <td>A304SE</td> <td>\$9.95</td> </tr> <tr> <td>Mac SE to ImageWriter II</td> <td>A305SE</td> <td>\$9.95</td> </tr> <tr> <td>Mac II 8 Pin Mini F/DB9 F Adaptor</td> <td>A101M2</td> <td>\$9.95</td> </tr> <tr> <td>Mac II to Hayes Compatible Modem</td> <td>A202M2</td> <td>\$9.95</td> </tr> <tr> <td>Mac II to ImageWriter I</td> <td>A203M2</td> <td>\$9.95</td> </tr> <tr> <td>Mac II to Laser Writer</td> <td>A304M2</td> <td>\$9.95</td> </tr> <tr> <td>Mac II to ImageWriter II</td> <td>A305M2</td> <td>\$9.95</td> </tr> <tr> <td>Apple II+ to ImageWriter II</td> <td>A307II</td> <td>\$9.95</td> </tr> <tr> <td>Apple II+ to Hayes Compatible Modem</td> <td>A204II</td> <td>\$9.95</td> </tr> <tr> <td>Apple II+ to ImageWriter II</td> <td>A307II+</td> <td>\$9.95</td> </tr> <tr> <td>Apple II+ to Hayes Compatible Modem</td> <td>A204I+</td> <td>\$9.95</td> </tr> <tr> <td>Apple IIe to ImageWriter II</td> <td>A307IE</td> <td>\$9.95</td> </tr> <tr> <td>Apple IIe to Hayes Compatible Modem</td> <td>A204IE</td> <td>\$9.95</td> </tr> <tr> <td>Apple IIc to ImageWriter II</td> <td>A308II</td> <td>\$9.95</td> </tr> <tr> <td>Apple IIc to ImageWriter LQ</td> <td>A308LQ</td> <td>\$9.95</td> </tr> <tr> <td>Apple IIc to Apple Personal Modem</td> <td>A308AM</td> <td>\$9.95</td> </tr> <tr> <td>Apple IIGS to 8 Pin Mini F/DB9 F Adap</td> <td>A101GS</td> <td>\$9.95</td> </tr> <tr> <td>Apple IIGS to Hayes Compat. Modem</td> <td>A202GS</td> <td>\$9.95</td> </tr> </table> | Mac to ImageWriter II | A306II | \$9.95 | Mac to ImageWriter LQ | A306LQ | \$9.95 | Mac to Apple Personal Modem | A306PM | \$9.95 | Mac to Hayes Modem, 300/1200/2400 | A203MM | \$9.95 | Mac+, 8 Pin Mini F/DB9 F Adaptor | A101M+ | \$9.95 | Mac+ to Hayes Compatible Modem | A202M+ | \$9.95 | Mac+ to ImageWriter I | A303M+ | \$9.95 | Mac+ to Laser Writer | A304M+ | \$9.95 | Mac+ to ImageWriter II | A305M+ | \$9.95 | Mac SE 8 Pin Mini F/DB9 F Adaptor | A101SE | \$9.95 | Mac SE to Hayes Compatible Modem | A202SE | \$9.95 | Mac SE to ImageWriter I | A303SE | \$9.95 | Mac SE to Laser Writer | A304SE | \$9.95 | Mac SE to ImageWriter II | A305SE | \$9.95 | Mac II 8 Pin Mini F/DB9 F Adaptor | A101M2 | \$9.95 | Mac II to Hayes Compatible Modem | A202M2 | \$9.95 | Mac II to ImageWriter I | A203M2 | \$9.95 | Mac II to Laser Writer | A304M2 | \$9.95 | Mac II to ImageWriter II | A305M2 | \$9.95 | Apple II+ to ImageWriter II | A307II | \$9.95 | Apple II+ to Hayes Compatible Modem | A204II | \$9.95 | Apple II+ to ImageWriter II | A307II+ | \$9.95 | Apple II+ to Hayes Compatible Modem | A204I+ | \$9.95 | Apple IIe to ImageWriter II | A307IE | \$9.95 | Apple IIe to Hayes Compatible Modem | A204IE | \$9.95 | Apple IIc to ImageWriter II | A308II | \$9.95 | Apple IIc to ImageWriter LQ | A308LQ | \$9.95 | Apple IIc to Apple Personal Modem | A308AM | \$9.95 | Apple IIGS to 8 Pin Mini F/DB9 F Adap | A101GS | \$9.95 | Apple IIGS to Hayes Compat. Modem | A202GS | \$9.95 |  <p>DATA SWITCHES</p> <p>VSI switches end cable swapping, share equipment. Need extra cables, we stock a broad selection.</p> <ul style="list-style-type: none"> • ONE YEAR WARRANTY, Deluxe All Metal Case • Compact Design, Rotary Switch • Full Shielding, Exceeds FCC Requirements <table border="0" style="width: 100%; border-collapse: collapse;"> <tr> <td>AB all models</td> <td>\$29.95</td> </tr> <tr> <td>ABCD all models</td> <td>\$39.95</td> </tr> </table> <p>Switch models available: 8 Pin Mini Din, 6 Pin Din, DB9, Parallel, Serial Aa x Bb (crossover), Parallel or Serial</p> | AB all models | \$29.95 | ABCD all models | \$39.95 | <p>Commodore cables also available.</p> |
| Mac to ImageWriter II | A306II | \$9.95 | | | | | | | | | | | | | | | | | | | | | | | | | | | | | | | | | | | | | | | | | | | | | | | | | | | | | | | | | | | | | | | | | | | | | | | | | | | | | | | | | | | | | | | | | | | | | | |
| Mac to ImageWriter LQ | A306LQ | \$9.95 | | | | | | | | | | | | | | | | | | | | | | | | | | | | | | | | | | | | | | | | | | | | | | | | | | | | | | | | | | | | | | | | | | | | | | | | | | | | | | | | | | | | | | | | | | | | | | |
| Mac to Apple Personal Modem | A306PM | \$9.95 | | | | | | | | | | | | | | | | | | | | | | | | | | | | | | | | | | | | | | | | | | | | | | | | | | | | | | | | | | | | | | | | | | | | | | | | | | | | | | | | | | | | | | | | | | | | | | |
| Mac to Hayes Modem, 300/1200/2400 | A203MM | \$9.95 | | | | | | | | | | | | | | | | | | | | | | | | | | | | | | | | | | | | | | | | | | | | | | | | | | | | | | | | | | | | | | | | | | | | | | | | | | | | | | | | | | | | | | | | | | | | | | |
| Mac+, 8 Pin Mini F/DB9 F Adaptor | A101M+ | \$9.95 | | | | | | | | | | | | | | | | | | | | | | | | | | | | | | | | | | | | | | | | | | | | | | | | | | | | | | | | | | | | | | | | | | | | | | | | | | | | | | | | | | | | | | | | | | | | | | |
| Mac+ to Hayes Compatible Modem | A202M+ | \$9.95 | | | | | | | | | | | | | | | | | | | | | | | | | | | | | | | | | | | | | | | | | | | | | | | | | | | | | | | | | | | | | | | | | | | | | | | | | | | | | | | | | | | | | | | | | | | | | | |
| Mac+ to ImageWriter I | A303M+ | \$9.95 | | | | | | | | | | | | | | | | | | | | | | | | | | | | | | | | | | | | | | | | | | | | | | | | | | | | | | | | | | | | | | | | | | | | | | | | | | | | | | | | | | | | | | | | | | | | | | |
| Mac+ to Laser Writer | A304M+ | \$9.95 | | | | | | | | | | | | | | | | | | | | | | | | | | | | | | | | | | | | | | | | | | | | | | | | | | | | | | | | | | | | | | | | | | | | | | | | | | | | | | | | | | | | | | | | | | | | | | |
| Mac+ to ImageWriter II | A305M+ | \$9.95 | | | | | | | | | | | | | | | | | | | | | | | | | | | | | | | | | | | | | | | | | | | | | | | | | | | | | | | | | | | | | | | | | | | | | | | | | | | | | | | | | | | | | | | | | | | | | | |
| Mac SE 8 Pin Mini F/DB9 F Adaptor | A101SE | \$9.95 | | | | | | | | | | | | | | | | | | | | | | | | | | | | | | | | | | | | | | | | | | | | | | | | | | | | | | | | | | | | | | | | | | | | | | | | | | | | | | | | | | | | | | | | | | | | | | |
| Mac SE to Hayes Compatible Modem | A202SE | \$9.95 | | | | | | | | | | | | | | | | | | | | | | | | | | | | | | | | | | | | | | | | | | | | | | | | | | | | | | | | | | | | | | | | | | | | | | | | | | | | | | | | | | | | | | | | | | | | | | |
| Mac SE to ImageWriter I | A303SE | \$9.95 | | | | | | | | | | | | | | | | | | | | | | | | | | | | | | | | | | | | | | | | | | | | | | | | | | | | | | | | | | | | | | | | | | | | | | | | | | | | | | | | | | | | | | | | | | | | | | |
| Mac SE to Laser Writer | A304SE | \$9.95 | | | | | | | | | | | | | | | | | | | | | | | | | | | | | | | | | | | | | | | | | | | | | | | | | | | | | | | | | | | | | | | | | | | | | | | | | | | | | | | | | | | | | | | | | | | | | | |
| Mac SE to ImageWriter II | A305SE | \$9.95 | | | | | | | | | | | | | | | | | | | | | | | | | | | | | | | | | | | | | | | | | | | | | | | | | | | | | | | | | | | | | | | | | | | | | | | | | | | | | | | | | | | | | | | | | | | | | | |
| Mac II 8 Pin Mini F/DB9 F Adaptor | A101M2 | \$9.95 | | | | | | | | | | | | | | | | | | | | | | | | | | | | | | | | | | | | | | | | | | | | | | | | | | | | | | | | | | | | | | | | | | | | | | | | | | | | | | | | | | | | | | | | | | | | | | |
| Mac II to Hayes Compatible Modem | A202M2 | \$9.95 | | | | | | | | | | | | | | | | | | | | | | | | | | | | | | | | | | | | | | | | | | | | | | | | | | | | | | | | | | | | | | | | | | | | | | | | | | | | | | | | | | | | | | | | | | | | | | |
| Mac II to ImageWriter I | A203M2 | \$9.95 | | | | | | | | | | | | | | | | | | | | | | | | | | | | | | | | | | | | | | | | | | | | | | | | | | | | | | | | | | | | | | | | | | | | | | | | | | | | | | | | | | | | | | | | | | | | | | |
| Mac II to Laser Writer | A304M2 | \$9.95 | | | | | | | | | | | | | | | | | | | | | | | | | | | | | | | | | | | | | | | | | | | | | | | | | | | | | | | | | | | | | | | | | | | | | | | | | | | | | | | | | | | | | | | | | | | | | | |
| Mac II to ImageWriter II | A305M2 | \$9.95 | | | | | | | | | | | | | | | | | | | | | | | | | | | | | | | | | | | | | | | | | | | | | | | | | | | | | | | | | | | | | | | | | | | | | | | | | | | | | | | | | | | | | | | | | | | | | | |
| Apple II+ to ImageWriter II | A307II | \$9.95 | | | | | | | | | | | | | | | | | | | | | | | | | | | | | | | | | | | | | | | | | | | | | | | | | | | | | | | | | | | | | | | | | | | | | | | | | | | | | | | | | | | | | | | | | | | | | | |
| Apple II+ to Hayes Compatible Modem | A204II | \$9.95 | | | | | | | | | | | | | | | | | | | | | | | | | | | | | | | | | | | | | | | | | | | | | | | | | | | | | | | | | | | | | | | | | | | | | | | | | | | | | | | | | | | | | | | | | | | | | | |
| Apple II+ to ImageWriter II | A307II+ | \$9.95 | | | | | | | | | | | | | | | | | | | | | | | | | | | | | | | | | | | | | | | | | | | | | | | | | | | | | | | | | | | | | | | | | | | | | | | | | | | | | | | | | | | | | | | | | | | | | | |
| Apple II+ to Hayes Compatible Modem | A204I+ | \$9.95 | | | | | | | | | | | | | | | | | | | | | | | | | | | | | | | | | | | | | | | | | | | | | | | | | | | | | | | | | | | | | | | | | | | | | | | | | | | | | | | | | | | | | | | | | | | | | | |
| Apple IIe to ImageWriter II | A307IE | \$9.95 | | | | | | | | | | | | | | | | | | | | | | | | | | | | | | | | | | | | | | | | | | | | | | | | | | | | | | | | | | | | | | | | | | | | | | | | | | | | | | | | | | | | | | | | | | | | | | |
| Apple IIe to Hayes Compatible Modem | A204IE | \$9.95 | | | | | | | | | | | | | | | | | | | | | | | | | | | | | | | | | | | | | | | | | | | | | | | | | | | | | | | | | | | | | | | | | | | | | | | | | | | | | | | | | | | | | | | | | | | | | | |
| Apple IIc to ImageWriter II | A308II | \$9.95 | | | | | | | | | | | | | | | | | | | | | | | | | | | | | | | | | | | | | | | | | | | | | | | | | | | | | | | | | | | | | | | | | | | | | | | | | | | | | | | | | | | | | | | | | | | | | | |
| Apple IIc to ImageWriter LQ | A308LQ | \$9.95 | | | | | | | | | | | | | | | | | | | | | | | | | | | | | | | | | | | | | | | | | | | | | | | | | | | | | | | | | | | | | | | | | | | | | | | | | | | | | | | | | | | | | | | | | | | | | | |
| Apple IIc to Apple Personal Modem | A308AM | \$9.95 | | | | | | | | | | | | | | | | | | | | | | | | | | | | | | | | | | | | | | | | | | | | | | | | | | | | | | | | | | | | | | | | | | | | | | | | | | | | | | | | | | | | | | | | | | | | | | |
| Apple IIGS to 8 Pin Mini F/DB9 F Adap | A101GS | \$9.95 | | | | | | | | | | | | | | | | | | | | | | | | | | | | | | | | | | | | | | | | | | | | | | | | | | | | | | | | | | | | | | | | | | | | | | | | | | | | | | | | | | | | | | | | | | | | | | |
| Apple IIGS to Hayes Compat. Modem | A202GS | \$9.95 | | | | | | | | | | | | | | | | | | | | | | | | | | | | | | | | | | | | | | | | | | | | | | | | | | | | | | | | | | | | | | | | | | | | | | | | | | | | | | | | | | | | | | | | | | | | | | |
| AB all models | \$29.95 | | | | | | | | | | | | | | | | | | | | | | | | | | | | | | | | | | | | | | | | | | | | | | | | | | | | | | | | | | | | | | | | | | | | | | | | | | | | | | | | | | | | | | | | | | | | | | | |
| ABCD all models | \$39.95 | | | | | | | | | | | | | | | | | | | | | | | | | | | | | | | | | | | | | | | | | | | | | | | | | | | | | | | | | | | | | | | | | | | | | | | | | | | | | | | | | | | | | | | | | | | | | | | |

VSI 3641 S.W. Evelyn, Portland, OR 97219, Shipping \$3.00, VISA, MC, money orders accepted. Price & stock, subject to change.

failure by continuing as if nothing had happened. The only reinforcement is positive and the program avoids frustrating the child by not insisting on a correct answer.

The final selection is called Fast Letters, and of the three activities this one requires the highest cognitive skills. Stickybear once again takes over the screen and pronounces any letter the child selects. The difference between Fast Letters and Alphabet is that the only graphic to appear here is the upper- or lowercase representation of the letter itself. No animated graphics representations are displayed.

There are numerous alphabet programs on the market, but what separates Talking Stickybear Alphabet from the rest—including its nonspeaking predecessor—are its enhanced graphics and its impeccable speech emulation.

In almost every case, animation is full-blown—no token hand wave or eye blink here. The airplane flies across the screen—dipping, climbing, and skimming treetops as it goes by. The duck swims around the lake, bobbing its head under the water from time to time. Every graphic is also accompanied by appropriate digitized sound effects.

The “talking” portion of the program stands in testimony to the leaps and bounds by which the software industry has grown. You won’t have to interpret what Stickybear is saying; the digitized voice pronounces both letters and words more clearly than many people.

Talking Stickybear Alphabet comes on two copy-protected 3½-inch disks and requires 512K of memory. You can install the program on a hard disk, but you’ll still have to place the master disk in a drive before the program will run. This type of “key disk” protection minimizes the benefits of a hard drive and can’t be applauded.

Note also that if your GS is equipped with the minimum 512K required by the program, you may not be able to launch Talking Stickybear Alphabet from the Finder, because the Finder itself requires a certain amount of memory overhead.

Despite these caveats, Talking Stickybear Alphabet is a superior program. Children under the age of 7 will be enthralled not only by the animated graphics screens that have been a hallmark of Stickybear programs since the very first, but also by the near-perfect speech and sound effects accompanying them. □

James V. Trunzo
Leachburg, PA

Now Offering

The Biggest Variety In Affordable Software

PDE — Your Source for Public Domain, Shareware and Beyond

APPLE IIgs 3½" DISKS — APPLE II 5¼" DISKS

Print Shop Graphics/Graphic Utilities

- GS61,GS62** 200+ holiday color & b/w graphics, fonts & borders for use w/Print Shop™ (2 DISK SET) . \$18
- GS63** CheapPaint—Hi quality commercial-like color graphics program (768K RAM required) (SHAREWARE) \$9

PaintWorks Gold™

— The IIgs paint program that sets the standard for all others. Over 80 new features, most not found on other paint programs.

Apple IIgs version \$66



- GS5** Convert pictures from any computer to IIgs format, need 512K RAM (SHAREWARE) \$9
 - GS45*** Borders to frame cards, stationery, etc. \$9
- *Requires PaintWorks Gold™, Deluxe Paint II™ or P.D.E. GS63.

Communication

- GS6** Freeform telecom-rated A+ Mag's "All Stars," NEEDS 512K. \$9

Fonts and Desk Accessories

- GS2,GS3,GS4** DAs: Picsaver, Notepad, Calendar, melting screen, plus more! (3 DISK SET) \$27
- GS25,GS26** 100 fonts formal to fancy for cards and documents for all occasions (2 DISK SET) \$18
- GS85** Control Panel NDA: Get to the Control Panel from the Apple menu, plus 20 other DAs \$9

Games

- GS15** Blackjack and Othello. Need 512K RAM . . . \$9
- GS27** IIgs Little BrickOut game (SHAREWARE) \$9
- GS36,GS37** Play the open but treacherous fairways of Jax & 11 more games w/your Mean 18™ (2 DISK SET) . . \$18
- GS46** Six more courses for computer golf junkies. (Mean 18™ is required for all courses) \$9

Mean 18™

— The most true-to-life golf simulation game ever. Truly legendary. Requires 512K memory.

Apple IIgs version \$29



- GS58** F1 Race: Formula One racing game (SHAREWARE). A+ Editors Choice ★Best Seller \$9
- GS86** Wheel: Vanna's game is now on the IIgs! \$9
- GS89** Backgammon, Video Poker, more \$9

Music

- NEW GS94** R & R Gold II: Self-running slide show with music. Madonna, RUN DMC, ZZ TOP, more (512K REQ.) . . \$9

Utilities/Personal Productivity

- GS1** DiversiCache/Copy/Key, plus Diversi-Hack 1.6 (needs 512K memory, 1 meg recommended) (SHAREWARE) . . . \$9
- GS68** Mailing Labels (sorts), cassette labeler, virus detector \$9
- GS73** Fast disk copier, quick program launcher, Fkeys . \$9
- GS87** ICONED: Design, edit, & color your icons (SHAREWARE) A+ Editors Choice ★Best Seller \$9

Business/Home

- 037** Full-featured word processor (II+ needs paddles or joystick + lower case display chip) \$5
- 056** Versatile Check Balancer, w/doc (SHAREWARE) . . . \$5
- 406** Address/phone Dbase w/RAM drive (SHAREWARE) . \$5
- NEW 840** Financial Wizard: Loans, Depreciation, Investments, etc.(SHAREWARE) \$5

CAD

- 310/311/312** CAD & graphing pkg. (REQ. PRINT PROG. 3 DISKS) \$15

Design Your Own Greeting Cards!

- Over 800 additional B/W graphics for use w/Print Shop™
- 10 5¼" disks \$39.95

Print Shop™

— The world's most popular graphics software. Just point your mouse click and create letterhead, logos, and much more.

- Apple II version \$35
- Apple IIgs version \$42
- Apple IIe Teacher's Edition . \$42



Communication

- NEW 825** Diversi-Dial: Powerful BBS. Up to 7 on-line users at once. (Req. Apple-Cat modem) (SHAREWARE) \$5
- 832** ATP-PRO: terminal emulator for IIc, IIe, or IIgs w/80-col. & Super Serial Card (Req. ProDOS) (SHAREWARE) . . . \$5

Education/Computer Learning

- 000** Learn BASIC programming, assembler \$5
- 064** Drills: typing, spelling, history, SAT \$5
- 085** Elem math: +, -, x, ÷, 23 levels \$5
- 768,769** Grade utility program for teachers (2 DISK SET) . \$10
- NEW 837,838** SAT vocabulary drills (2 DISK SET) . . . \$10

Games/Entertainment

- 126** Anti-Gravity — Fast action — Addictive! \$5
- 127** Defender (like arcade version), D-Day (JOYSTICK REQ.) \$5
- 131** Electronic jigsaw puzzle \$5
- 190,191** Nudes: Graphics & games, adults only (2 DISKS) \$10
- 194** Genealogy Program: Family Tree \$5
- NEW 786** U.S. War: East vs West, who will win!, more . \$5
- NEW 814** Monopoly: Apple II vers. of popular board game \$5
- NEW 852** Mars: Text adventure set in space, Beach Party, Poacher Wars, more \$5

Utilities

- 779,780** Drive cleaner, disk & memory tester (2 DISK SET) \$10
- NEW 816** Disk Manager: All-purpose utility, print labels, copy disks \$5
- NEW 843** ListWorks: Accepts ASCII text files and prints in many different formats \$5

Copy II Plus™

— The #1 utility program for the Apple II/IIgs. Delete and undelete, copy, view, and print files. Too many other functions to list.

- Both 5¼" & 3½" disks inside . \$24



SPECIAL! Any 6 (\$5/\$9) Disks + 1 Yr. Membership Only \$39⁹⁵
Includes — 350 pg. Dirctry, PDE Qtrly. Mag, Members Only Discounts (Add S/H)

Add \$4 (\$10 foreign) shipping for disk orders. CA add sales tax.
*Offer good for these disk numbers only.

Enclosed \$ _____ by Check VISA MC
Card No. _____ Exp. _____
Name _____
Address _____
City _____ State _____ Zip _____

P.D.E.
The Public Domain Exchange
2074-C Walsh Ave., #771
Santa Clara, CA 95050

DEALER INQUIRIES INVITED

ORDER TOLL FREE 800-331-8125 IN CA 408-496-0624



PAUL STATT PLAYS...

Uninvited GS, Mindscape, 3444 Dundee Road, Northbrook, IL 60062, (312) 480-7667, \$49.95

THE PREMISE OF UNINVITED IS inviting, so to speak. You drive your car into a tree in front of an ancient Victorian mansion, a "haunted house" if ever you saw one. Your brother, who was with you, disappears while you're blacked out. He must be in the house.

You'll actually see all this happening—Uninvited is a graphics adventure, not a text adventure. As you crawl from the wreckage, stroll up to the house, walk in "uninvited," and explore the many rooms, you're looking



at pictures. To move, to look at things, or to pick things up, you must point and click with your GS' mouse.

The interface works surprisingly well. Double-clicking on a door opens it, double-clicking on an open door makes you walk through.

Double-click on a portrait to see it. The interface isn't slow, but the screen quickly becomes as cluttered as your grandmother's bedside table.

The allure of the graphics interface, however, fades faster than old newspapers. I explored the house happily, poking into broom closets, browsing in the library, reading other people's mail and diaries, and even (because I do have some experience with adventure games) picking up everything in sight.

But I died young. In every adventure from Eamon to Zork, I've died young, but my Uninvited death was particularly graphic. I never found my brother, and never satisfied my curiosity about the owner of the house. Was it really H.P. Lovecraft—the H.P. Lovecraft?

Adventure games in general, and Uninvited

SHORT TAKES

FINAL ASSAULT

Epyx, P.O. Box 8020, 600 Galveston Drive, Redwood City, CA 94063, (415) 366-0606, \$44.95

Now here's something you haven't seen simulated before—mountain climbing. Final Assault incorporates realistic variables (hunger, cold, and unstable snow) and uses excellent graphics for an interesting alpine experience. (See Games Editors Play, June 1989, p. 117.)

Rating: ♦ ♦ ♦

THE ANCIENT ART OF WAR AT SEA

Broderbund Software, 17 Paul Drive, San Rafael, CA 94903-2101, (415) 482-3500, \$44.95

The Ancient Art of War at Sea tests your artfulness on all levels—strategic decisions, individual ship handling and combat, and hand-to-hand combat after you've boarded another ship. It's a brilliant simulation—guaranteed to make you whistle a few sea chanteys. (See Games Editors Play, June 1989, p. 117.)

Rating: ♦ ♦ ♦ ♦

THE GAMES: WINTER EDITION

Epyx, P.O. Box 8020, 600 Galveston Drive, Redwood City, CA 94063, (415) 366-0606, \$49.95

Downhill skiing, slalom skiing, luge, figure skating, speed skating, ski jumping, and cross-country skiing all in one? It must be one of Epyx's series. The long-awaited Winter Edition includes some excellent games (and one or two mediocre ones). (See Games Editors Play, May 1989, p. 66.)

Rating: ♦ ♦ ♦

SERVE AND VOLLEY GS

Accolade, 550 South Winchester Boulevard, San Jose, CA 95128, (408) 985-1700, \$39.95

This is the stuff real tennis is made of—precise timing, absolute concentration, even line judges and seed orders. Like Accolade's Hardball and Mean 18 (baseball and golf games, respectively), Serve and Volley is sure to become a classic in the sports genre. (See Games Editors Play, March 1989, p. 83.)

Rating: ♦ ♦ ♦ ♦

SUPERSTAR ICE HOCKEY

Mindscape, 3444 Dundee Road, Northbrook, IL 60062, (312) 480-7667, \$44.95

Superstar Ice Hockey is a good, fun game. The smoothly scrolling graphics are most impressive (even the spray of ice shavings when your players stop and change directions). The only really annoying thing is the dim-witted goalie who stops the puck, then drops in front of the net—regardless of the color of the jerseys surrounding him. (See Game Editors Play, May 1989, p. 66.)

Rating: ♦ ♦ ♦

ARKANOID IIe/IIc

Taito, 267 West Esplanade, North Vancouver, BC, Canada V7M 1A5, (604) 984-3344, \$29.95

Just as addictive as the game you love on your GS and in your local pizza parlor, although the less sophisticated graphics and sound effects don't warp space with quite the same effect. (See Games Editors Play, May 1989, p. 67.)

Rating: ♦ ♦ ♦ ♦

in particular, need to improve what literature professors call "character development." Uninvited's got the plot and the locale, but where are the people? If I didn't meet them I assume they're too hard to find.

LAFE LOW PLAYS . . .

War in Middle Earth, Melbourne House, 711 West 17th Street, Costa Mesa, CA 92627, (714) 631-1001, \$49.99

THIS WAS QUITE AN AMBITIOUS undertaking for the programmers of Melbourne House—capturing the vastness of J.R.R. Tolkien's Middle Earth on scant computer disks. Nevertheless, it appears they've succeeded. You guide Frodo, Sam, and Pippin throughout their "quest" (although I

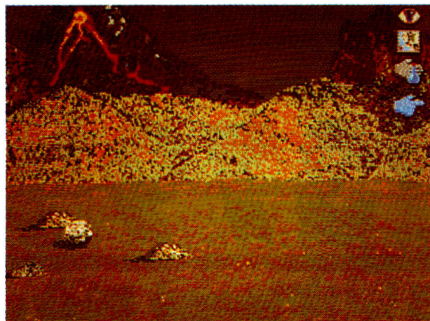

hate to use that word, because it's such a cliché in adventure games) to destroy the magic ring in the fires of Mount Doom, smack in the middle of Mordor.

Along the way, you'll inevitably do battle with orcs and other evil denizens of Middle Earth. Like our literary heroes in the trilogy, you'll have to keep on your toes, stay on the right roads, and forge the right alliances.

Trying to save Middle Earth from the clutches of the evil wizard Sauron and his legions of mean and nasty critters is fun—graphics and animation are smooth and artistic. But what's better is just scrolling around the colossal map of Middle Earth and zooming in wherever you have the urge to investigate.

That's true to the Hobbit spirit—exploring the far reaches of the Shire, Mirkwood, and beyond from the safety and comfort of home.

. . . and plays . . .

The Games: Summer Edition, Epyx, 600 Galveston Drive, P.O. Box 8020, Redwood City, CA 94063, (415) 366-0606, \$49.95

HERE WE GO AGAIN—INTO THE Olympic arena with Epyx. As the "other season" companion to The Games: Winter Edition, the summer series offers an equally faithful experience. From the

"Olympic Village," you can opt to compete (or practice) in diving, rings, hammer throw, pole vault, archery, uneven parallel bars, bicycling, or hurdles.

Diving was my favorite event, followed by



bicycling and archery. I'm no Greg Louganis or John Williams (a famous archer; I figure you all know who Louganis is), but I managed to walk away with a medal or two.

Bicycling is also exciting. You have to keep to a smooth, steady rhythm, much as you do in Winter Edition speed skating.

All the games are enjoyable, but I think it's most interesting to play something that isn't simulated anywhere else. For originality alone, Epyx will go home with the gold. As for the individual games, they'll take a few silvers. □

ARKANOID GS

Taito Software, 267 West Esplanade, North Vancouver, BC, Canada V7M 1A5, (604) 984-3344, \$29.95 (requires mouse)

Classic arcade action—this GS version looks as good or better than the games you've played in pizza parlors and video arcades. You better buy this one—you'll save a lot in quarters. (See Games Editors Play, March 1989, p. 83.)

Rating: ♦ ♦ ♦ ♦ ♦

WARLOCK GS

Three-Sixty Pacific, 2105 South Bascom Avenue, Suite 290, Campbell, CA 95008, (408) 879-9144, \$39.95

Don't worry, this isn't another fantasy role-playing game that takes the better part of a year to complete. This is fast-moving arcade-type action, with a bit of mystical magic mixed in—all-around good fun. Let us know if you get past level 12. (See Games Editors Play, March 1989, p. 82.)

Rating: ♦ ♦ ♦ ♦

BUBBLE GHOST GS

Accolade, 550 South Winchester Boulevard, San Jose, CA 95128, (408) 985-1700, \$34.95

Casper's gone from kids' cartoons to computer games. Direct a pesky little ghost to blow a bubble throughout a series of maze-like rooms that look like your worst nightmare. Terrific graphics and bizarre sound effects add to this unique game. (See Games Editors Play, March 1989, p. 82.)

Rating: ♦ ♦ ♦

CALIFORNIA GAMES GS

Epyx, P.O. Box 8020, 600 Galveston Drive, Redwood City, CA 94063, (415) 366-0606, \$44.95

Super graphics and radical music make the GS version of this old favorite cooler than ever. Surfing's the best, but you've also got half-pipe skateboarding, roller-skating, footbag, bicycle motocross, and flying disk. The only things missing are sunburn and salt spray. (See Games Editors Play, February 1989, p. 90.)

Rating: ♦ ♦ ♦ ♦ ♦

MINI-PUTT

Accolade, 550 South Winchester Boulevard, San Jose, CA 95128, (408) 296-8400, \$39.95

To the best putter go the spoils, not to mention the windmills and elephants, over four minimalist courses of nine holes each. It's not as wacky as Electronic Arts' Zany Golf; it's played on a two-dimensional map without the labyrinthine twists and turns. Music and animation are also missing, but Mini-Putt's a tougher athletic challenge. (See Games Editors Play, February 1989, p. 90.)

Rating: ♦ ♦ ♦ ♦

RAMPAGE

Activision Inc., 3885 Bohannon Drive, Menlo Park, CA 94025, (415) 329-0800, \$34.95

Good, old-fashioned, smash-'em-up arcade fun—monsters loose on the streets, in the cities, climbing buildings. You're one of them—pound those tanks into the dirt. What more can we say? (See Games Editors Play, May 1989, p. 66.)

Rating: ♦ ♦ ♦ ♦

COMPUTER DIRECT

Since 1979

WE WON'T BE UNDERSOLD!*

EXPIRES 7/31/89

No One Can Sell This Printer For Less 180 CPS Printer

Lifetime Warranty on Printhead
our Best Printer Buy

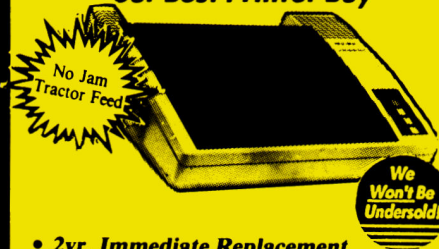

- 2yr. Immediate Replacement
- Dot Addressable Graphics
- High Speed Square Dot Matrix
- Italics, Elite, Condensed, Pica
- Centronics Parallel Port
- 8K Print Buffer
- NLQ Selectable from Front Panel
- Low Cost Adapters Available
- Pressure Sensitive Controls

Our Low Sale Price
\$149⁹⁵
List \$499

2400 Baud External Modem 100% Hayes Compatible Made Especially For You!

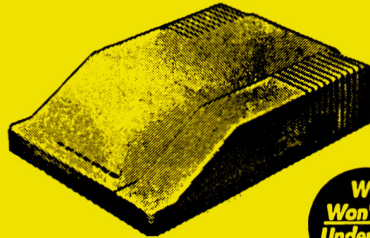

- 7 System Indicator Lights
- Both Tone & Pulse Dialing
- Built-in Speaker with Volume Control
- For all Computers

Everyday Low Price
\$99⁹⁵
List \$349

LASER 128 Computer

Apple Compatible

The best elements of the IIc and IIe in
one great computer.



FREE Quality Word Processor, Spread-
sheet & Database a \$209 value

- 32K ROM • 128K RAM
- 5 1/4" Disk Drive • Video/RGB Port
- Centronics Parallel Interface Port
- Serial & Modem for 232C Interface
- Joystick/Mouse port

Our Low Sale Price
\$379⁹⁵
List \$499

Laser 128/Apple IIc or IIe 160K 5 1/4" Disk Drive

- 256 Bytes
- 160K Bytes Capacity
- 5 1/4" Floppy Disk Drive
- For Laser/Apple IIc or IIe

\$87⁹⁵
List \$299

Laser 128, Macintosh, IIe or II plus 800K 3 1/2" Disk Drive

LASER



- 800K Memory
- 3 1/2" Micro Disk Drive
- For Laser 128, Macintosh
- Apple IIe, or II plus

Our Low Sale Price
\$199⁹⁵
List \$299

SIZZLING FREE GIFT OFFER!

(With Any Order)

• Disk Drive Cleaner

---Please Specify 5 1/4" or 3 1/2"---

LIST \$14⁹⁵

• Webster's Dictionary of Computer Related Terms

---Every Word You Need To Know---

LIST \$9⁹⁵

• Disk Notcher

---Turns SSDD disks into DSDD disks---

LIST \$9⁹⁵

5 1/4" Floppy Disks

100% Certified • Lifetime Guarantee
Double Sided • Double Density

Low As

19^c
ea.



Qty. of 25 \$4.75
Qty. of 25 w/sleeves..... \$5.25
Qty. of 100 w/sleeves & labels..... \$24.00

Made In The USA

3 1/2" MicroDisks

100% Certified

Double Double
Sided Density



60% clip rate makes
this the best deal in
the country!

No Limit

Lots of 50 - 99^c

Lots of 250 - 69^c

69^c
ea.

IMMEDIATE ANSWER

800 - BUY - WISE ext. 24

800 - 289- 9473 ext. 24

Outside Service Area call 312 -382-5058

We Love Our Customers!

COMPUTER DIRECT

22292 N. Pepper Rd.

Barrington, IL 60010

Circle 205 on Reader Service Card.

BEST SERVICE IN THE USA

PRICE IS NOT ENOUGH!

- 90 Day Immediate Replacement
- Free Technical Assistance
- Fast, Low Cost Delivery
- 15 Day Home Trial
- Experts in Customer Satisfaction
- Bulletin Board Service
- No Credit Card Fees
- Free Catalogs



Where in the World is Carmen San Diego?

Track Carmen's gang all around the world finding clues and consulting the World Almanac and Book of Facts (included). Joystick/Keyboard. 64K. Apple II Series or LASER 128. BR0500Z List \$39.95 **SALE \$24.95**

Walt Disney's

Matterhorn Screamer

Even Goofy wants to be a hero. Dodge crafty mountain goats, evade abominable snowmen and climb up & down rugged slopes.

HT0750Z List \$9.95 **SALE \$6.95**

Concentration

Test your memory as you match the pairs of prizes on the board and uncover pieces of a hidden puzzle. 128K. Apple II Series or LASER 128.

SA0320Z List \$12.95 **SALE \$8.95**

SIZZLING DISK SALE!



Fuji Double Sided/Double Density

List \$2.29ea....Sizzler Price **69¢**
Box of 10 plus 1 FREE! \$6.90

Dysan

There's nothing flexible about Dysan quality.

5 1/4" Disks

Double Sided/Double Density

List \$2.09 ea....Sizzler Price **79¢**
Box of 10 \$7.90 with sleeves & labels.

SONY

MFD-2DD 3 1/2" Disks

Double Sided/Double Density

List \$3.49 ea Sizzler Price **\$1.29**
Box of 10 \$12.90

Introducing...

HOME OFFICE

*The Power of the Office
In the Comfort Your Home.*

Featuring;

- Canon Copiers
- Murata FAX Machines
- Laser Printers
- System Stands
- Much, Much More!

*From Our Home ...
...To Your Home*

The Ergostick

Shatters the Gap Between Action and Reaction

- True Ergonomic Design
- Soft & Pliable
- Formfit to the Human Hand
- Microswitch Technology



Sizzler Price

\$29.95

List \$39.95

GEOMOUSE for the APPLE II Series and LASER

Sizzler Price

\$49.95

List \$99.95

FREE CATALOG



Call For Your Free Catalog With Everything You Need For Apple

1200 Baud Migent Pocket Modem

100% Hayes Compatible



- Runs on AC or Battery
- Turns on/off automatically
- Plugs directly into your serial port on many computers
- On-screen status lights show call progress
- RS232 Compatible
- *Free Source With \$15 Of On-line Time
- *Free Official Airline Guide Electronic Edition
- *Free Comuserve With \$15 Of On-line Time

Our Low Sale Price

\$59.95

VISA
MASTER CARD
COD

COMPUTER DIRECT will match any current (within 30 days), valid nationally advertised delivered price on specially marked items of the exact same product with a comparable payment method, excluding any applicable sales taxes. Verification Required.

Prices do not include shipping charges. Call to get your lowest delivered cost. We insure all shipments at no extra cost to you! all packages are normally shipped UPS Ground. 2nd Day or Overnight Delivery available. Minimum shipping charge per order is \$3.75. Illinois residents add 6 1/2% sales tax. We ship to all points in the U.S., Canada, Puerto Rico, Alaska, Hawaii, Guam, and APO & FPO. (Color monitors shipped in Continental USA only.) PRICES AND AVAILABILITY SUBJECT TO CHANGE WITHOUT NOTICE.

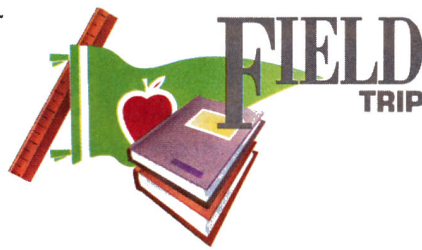

C OMPUTER MASTERY

Thanks to rabbits and bears, typing and information management are kid stuff. Take the fear out of computing with software that introduces children to their Apple IIs.

By **CYNTHIA E. FIELD, Ph.D.**

WHO SAYS KIDS HAVE TO DESCEND into the murky abyss of machine-language programming to become computer literate? Not Field Trip!

Among the five computer-literacy programs reviewed here, one features a popular bear family that helps even preschoolers decipher the QWERTY keyboard; a second program can literally talk elementary-school children through database-management basics; and still another gives junior- and senior-high-school kids a step-by-step guide to creating their own interactive fiction—with an assist from AppleWorks.

SO HOP TO IT!

COTTON'S FIRST FILES

Rabbits are infamous for "getting around." And Cotton is no exception. Initially this floppy-eared character showed up in **Cotton Tales**, the rebus-writing desktop-publishing program for young children. Now MindPlay's bunny is back in **Cotton's First Files**, a talking database-management program for youngsters aged 5–11.

Cotton's First Files helps children get a grasp on organizing information through colorful, animated graphics, musical rewards, and reassuring messages.

With a Street Electronics **Echo IIb** or **IIC** speech-synthesis device connected to your Ap-

ple II, Cotton even *speaks*—in a clear, feminine voice that bolsters kids' self-esteem with remarks such as "Great job!" or "Very good. You found the gorilla."

Cotton's First Files combines four activities: Peek and Find, File Hunt, Clue Search, and Build Your Own Files.

The first three games center on the program's built-in "Animals" database, which includes some 200 animal graphics. You can print records in the form of "data cards" on the Apple ImageWriter (or Silentype) or Epson printers.

Certain animal records are incomplete, and the program encourages kids to research the information in traditional media (magazines and books) and type it into the database.

FUN AND GAMES

AND REASONING SKILLS

But first things first—games! In Peek and Find, Cotton challenges you to search through the labeled file drawers that appear on screen and "Find the Wolf" or other animal whose picture and name are displayed.

Do you look in the "Wings" drawer? The "Pets" drawer? How about the "4 Legs" drawer? Pick a drawer and watch animal graphics parade out until you find the right match.

File Hunt presents a written description. Read it for clues, then search through the screen's file drawers to find the target animal.

Clue Search, the third game, provides hints about an animal. If the Clue reads "large sea-bird," it might be a good idea to look in the "Water" drawer, but pass up the "Furry" drawer.

DATA ORGANIZATION: CUSTOMIZE YOUR FILES

Build Your Own Files gives children the opportunity to create custom databases. Follow suggestions given in the manual (birthdays, explorers, vocabulary words) or come up with your own ideas.

For each record, type in the name, a short description, and clues. Select a graphic from the animal illustrations provided on the program disk or from drawings in **Cotton Plus**, a 160-picture library the company sells



Mavis Beacon's rival car is traveling at your target pace, but speed and accuracy will send you flying past.

separately. MindPlay's trademark Challenge Upgrade lets parents control the complexity of each activity. Among other options, you can limit the number of file drawers and control game speed.

Parents or older brothers and sisters who want to become more directly involved in a preschooler's computing exercises can investigate Sunburst's **Muppet Learning Keys Toolkit**.

The ready-made programming routines included let you make custom educational software—or listable public-domain programs—that support **Muppet Learning Keys**, the sturdy “children's keyboard” available from Sunburst Communications.

The Key Editor program on the Toolkit disk lets you change the identity of selected keys by typing in alternative ASCII values, a handy feature if you intend to use keyboard overlays with preschool programs.

Implementing programs from the Muppet Learning Keys Toolkit presupposes experience with the computer language BASIC, so this package isn't for everyone.

But parents or teens who like to program and who want to expand a younger child's software repertoire at the same time should take a closer look at this product.

FICTION WRITING FOR CREATIVE TEENS

Teenagers with a creative-writing streak and a love for computing can take a lesson—or two or three—from Chet Day, a novelist, ed-

“AMONG POPULAR LITERACY PROGRAMS, ONE FEATURES BEARS TO GUIDE YOU THROUGH TYPING; ANOTHER TALKS YOU THROUGH DATA MANAGEMENT; A THIRD HELPS YOU WRITE INTERACTIVE FICTION.”

School in New Orleans, Louisiana.

The “Guide” includes AppleWorks word-processing files containing the program's documentation—an entertaining and well-written user's guide for individual creative writers and a teacher's guide complete with course syllabus.

The two-sided program disk (a low-cost demo disk is available) includes a copy of Tom Weishaar's public-domain program Type, and a sample interactive-fiction story called “The Morgue.”

DARK AND STORMY NIGHTS: ANALYZING YOUR WRITING

Using “The Morgue” as an example, Day leads you step by step through the creation of

location and object information, which will eventually show up on screen during play.

Finally, write the game's program code in Applesoft BASIC.

Sounds daunting? It's not. Day gives line-by-line explanations of each command's or variable's function. He even provides a “skeleton” program you can build on or change as you become adept at writing interactive fiction.

Ever the teacher, Day includes time- and frustration-saving hints along with graphic-design and desktop-publishing project ideas to help you “market” your story.

Day's also compiling a public-domain disk, **The Penman's Pick: Top-Notch Adventures**, which contains stories that users of Shem the Penman's Guide submitted.

BEARLY WORKING: BEDFORD'S GUIDE TO GOOD TYPING

Before a youngster even begins to think about programming imaginative, interactive stories, he or she should strive to abandon the “hunt and peck” method of cruising around the Apple II keyboard. With programs like **Stickybear Typing** from Optimum Resource/Weekly Reader, even the youngest computerphiles in your family can tame the dread QWERTY monster. (Check the accompanying sidebar for other sources of typing programs.)

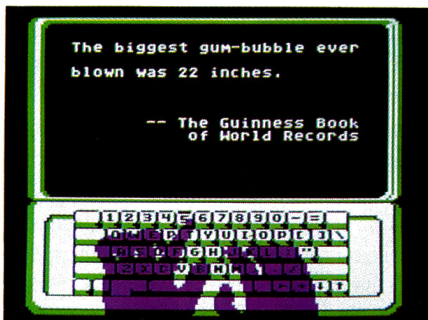

Guide Hands help beginners learn correct finger placement in **Mavis Beacon**.



Stickybear Thump: This robot throws a mean curve ball.

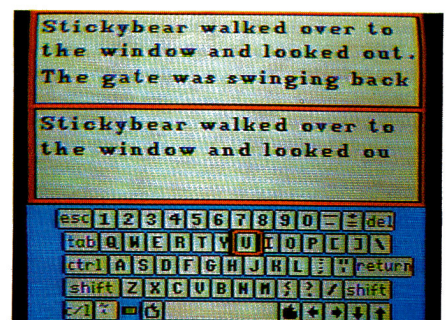

Stickybear Typing's Keypress activity: Practice makes perfect.

ucator, and author of **Shem the Penman's Guide to Creative Writing, Reasoning, and Programming**. Day developed and refined his hands-on system for creating text-only interactive fiction at the Metairie Park Country Day

your own story.

Begin by mapping the “Core Game,” then use the AppleWorks word processor (or another word processor than can save files in ASCII format) to type text files containing

Stickybear Typing offers three activities: Stickybear Keypress, Stickybear Thump, and Stickybear Stories.

In Keypress you practice typing whatever appears on screen. Use the on-screen key- ▶

TYPING ASSISTANTS

If **Stickybear Typing** and **Mavis Beacon** aren't in sync with *your* learning style, check out this list of typing helpers. At least one of the nearly two dozen programs included here should suit you to a capital T!

Dungeon Doom Typing Game, \$44.95
Backup Disk, \$10
Lab Pack

Network Version
\$164.95 each
requires 48K
ages 11–adult
Gamco Industries
P.O. Box 1911K34
Big Spring, TX 79721
(800) 351-1404
(915) 267-6327
(collect in TX)

How Fast Can You Type Right?, \$39.95
Class Pack, \$240
requires 48K
Typing Strategy, \$39.95
requires 48K
Opportunities for Learning
20417 Nordhoff St.
Chatsworth, CA 91311
(818) 341-2535

Junior Typer
Aquarius Instructional Material
P.O. Box 128
Indian Rocks Beach, FL 34635
(813) 595-7890
\$45
ages 8–11
requires 48K

Just Your Type
Right On Programs
755 New York Avenue
Huntington, NY 11743

(516) 424-7777
\$50
all ages
requires 48K

Keyboard Cadet, \$29.95
Lab Pack, \$59.90
ages 7–18
requires 48K
MasterType, \$39.95
Lab Pack, \$79.90
ages 7–18
requires 48K
Typing Well, \$49.95
Lab Pack, \$99.90
ages 8–18
requires 48K
Mindscape, Inc.
3444 Dundee Road
Northbrook, IL 60062
(800) 221-9884
(312) 480-7667

MicroType: The Wonderful World of Paws, \$39.95
Lab Pack (5 copies), \$289.75
ages 7–11
requires 48K
Rainbow Keyboarding, \$46.70
ages 7–9
requires 64K
Success with Typing, \$69.95
Lab Pack (5 copies), \$109.95
ages 10 and up
requires 64K
SuperKey, \$59.95
Lab Pack (10 copies), \$195
ages 8–adult

requires 48K
Scholastic Inc.
P.O. Box 7502
2931 East McCarty Street
Jefferson City, MO 65102
(800) 325-6149
(800) 392-2179 (MO)
(314) 636-5271

Text Tiger, \$49.99
Lab Pack (6 copies), \$129
ages 6–18
requires 48K
MindPlay
Unit 350
P.O. Box 36491
Tucson, AZ 85740
(800) 221-7911

TouchType, \$20
plus \$2.50 shipping
Site License, \$800
requires 64K with DOS 3.3
Kinko's Academic Courseware
Exchange
Box 800
Ventura, CA 93002-8000
(800) 235-6919
(800) 292-6640 (CA)
(805) 652-4158

Type!, \$26.95
Lab Pack, \$73.95
ages 10–18
requires 64K plus shift-key
modification for Apple II Plus
Broderbund Software
17 Paul Drive
San Rafael, CA 94903-2101
(800) 527-6263
(415) 492-3500

Typeasy
Focus Media, Inc.
839 Stewart Avenue
P.O. Box 865
Garden City, NY 11530

(800) 645-8989
(516) 794-8900
\$39
requires 48K

Type to Learn, \$75
Lab Pack (10 copies), \$225
requires 64K
free 3½-inch disk swap
Type to Learn Gradebook Disk, \$65
requires 64K
Type to Learn Posters, \$16
Type to Learn Workshop Manual, \$65
Type to Learn Student Activity Book, \$7.95

Tips for Teaching Keyboarding with Type to Learn Video
(Beta or VHS), free 30-day loan
to educators
Sunburst Communications
39 Washington Avenue
Pleasantville, NJ 10570
(800) 431-1934
(800) 221-5912 (NY)
(800) 247-6756 (Canada)
(914) 769-5030
ages 7 and up

Typing Is a Ball, Charlie Brown
McGraw-Hill
Princeton-Hightstown Road
Hightstown, NJ 08520
(800) 262-4729
\$29.95
ages 5–8
requires 48K

Typing Tutor IV, \$39.95
Lab Pack (5 copies), \$150
Simon & Schuster
Software Division
1 Gulf & Western Plaza
New York, NY 10023
(212) 373-8882

PRODUCT INFORMATION

Cotton's First Files, \$49.99
Lab Pack (6 copies), \$129
ages 5–11
requires 128K
supports Echo IIb and IIc
Cotton Plus, \$29.99
Lab Pack (6 copies), \$72
requires Cotton Tales
Cotton Tales, \$49.99
Lab Pack (6 copies), \$129
ages 5–8
MindPlay
Unit 350
P.O. Box 36491
Tucson, AZ 85740
(800) 221-7911

Echo IIb, \$129.95
Apple II Plus, IIe, GS
Echo IIc, \$179.95
Apple IIc, IIc Plus
Street Electronics
6420 Via Real

Carpinteria, CA 93013
(805) 684-4593

Mavis Beacon Teaches Typing!, \$39.95 IIe/IIc
backup disk, \$5
requires 64K
\$49.95 GS
backup disk, \$5
unprotected backup disk, \$10
requires 512K
The Software Toolworks
One Toolworks Plaza
13557 Ventura Blvd.
Sherman Oaks, CA 91423
(818) 907-6789
ages 7 to adult

Muppet Learning Keys
with Muppets on Stage
software, \$99
Apple II Plus Adaptor, \$9.95
requires 64K
Muppet Learning Keys Toolkit, \$40
free 3½-inch disk swap
requires 64K
ages 14 and up
Sunburst Communications
39 Washington Avenue
Pleasantville, NY 10570
(800) 431-1934
(800) 221-5912 (NY)
(914) 769-5030

Shem the Penman's Guide to Creative Writing, Reasoning, and Programming
\$65, home version or
unrestricted school site license
requires ASCII word processor

AppleWorks recommended
demo disk, \$3
Chet Day
625 Smith Drive
Metairie, LA 70005
E-mail GENIE: A2.CHET
ages 12 and up

Stickybear Typing, \$39.95
Lab Pack (5 copies), \$75
backup disk, \$10
free 3½-inch disk swap
all ages
Optimum Resource, Inc./
Weekly Reader Software
10 Station Place
Norfolk, CT 06058
(800) 327-1473
(203) 542-5553

board and "helping hands" as aids in locating correct keys and learning proper finger positions. A "progress report" at the end of each practice session tracks your speed in words per minute as well as your errors.

Begin at Level 1 (the *j, k, d, f*, spacebar, and Return keys), progress through Level 24 (the @ sign), and finally achieve Level 30 (proper spacing and mastery of the most commonly misspelled words). The program offers three-minute and five-minute timed tests.

In Stickybear Thump, you'll have to type fast to prevent Bedford Stickybear from being "thumped" by blocks hurled by a robot. You'll have to type even faster to have Stickybear throw a ball to stop the block in midair.

Select "Stories," "Riddles and Jokes," or "Serious Thinking" for typing practice sessions. Working with selections from these categories can make keyboarding chores more "real"—even if the passages you're typing are from "Waiter, waiter!" jokes.

AI IN TYPING?

MAVIS BEACON'S A WINNER

If you're looking for a "one size fits all" typing program, **Mavis Beacon Teaches Typing!** from The Software Toolworks may be it. The Apple II/GS version I tested (an Apple IIe/IIc version is also available) elevates attractive features found in other typing programs to new heights.

"Mavis" provides practice sessions of graduated difficulty, immediate feedback in nearly two dozen types of progress charts, and a car-racing game for variety's sake. But that's not all.

You'll be astounded by the GS version's graphics: the title screen with its "ancient" Underwood manual typewriter, the on-screen GS look-alike, and the Guide Hands that help beginners learn correct finger placement. (Mavis turns this feature off automatically if she "senses" you're an experienced typist.) The program's text appears in yellow, while your copycat typed material shows up in black and your mistakes in red.

Mavis Beacon Teaches Typing! is unique in a still more significant way. The program's artificial intelligence tailors each typing lesson to your individual needs—whether you've opted to learn the traditional QWERTY or the faster Dvorak layout, whether you're "under 9," "9-14," or "over 14" years of age.

You determine the length of each session, set your speed goal, and take a pretest. Mavis determines what kinds of errors you tend to

make and how you can correct them.

At the "Chalkboard"—a full-screen illustration that looks like the real thing—Mavis discusses each lesson in terms of the Problem, its Remedy, and a Focus. She may advise you to practice typing to the rhythm of an on-screen metronome, do transcription typing from one of the lessons contained in the program's manual, or perform the Shift Key Drill.

THE ENTERTAINING EXPERT: MAVIS MEANS BUSINESS

For a change of pace, Mavis may suggest the Arcade Race. Type whatever appears in "skywriting" and, watching the speedometer on your dashboard to keep track of words per minute, try to safely pass a rival car that's traveling at your target speed.

The program also allows for user "Alternatives." Ask Mavis to suggest another, "next best" lesson. Create a custom lesson that forces you to use one hand more than the other or to negotiate tricky letter combinations called "Keyboard Hurdles."

The program's easy-reader manual includes

"A History of Typewriting," samples of business letters, and a chapter describing "The Résumé Writer." This accompanying program helps you organize, select, and format education and employment information to present your qualifications in the best possible light.

Mavis Beacon Teaches Typing! offers conventional typing lessons through state-of-the-art personal-computing power. It's easy to be critical of programs that spew superlatives about themselves, but here's a software package that, as the manual asserts, is "the finest typing program in the history of microcomputing." Mavis Beacon Teaches Typing! is both expert *and* entertaining—a combination that may be impossible to beat. □

CYNTHIA FIELD IS A FREE-LANCE WRITER SPECIALIZING IN COMPUTER-RELATED TOPICS. SHE IS A CONTRIBUTING EDITOR AND THE AUTHOR OF PRESS ROOM, *INCIDER'S* COLUMN ON DESKTOP PUBLISHING. WRITE TO HER AT 60 BORDER DRIVE, WAKEFIELD, RI 02879. ENCLOSE A SELF-ADDRESSED, STAMPED ENVELOPE IF YOU'D LIKE A PERSONAL REPLY.

Never buy another ribbon!

MacInker Over 100,000 sold since 1982

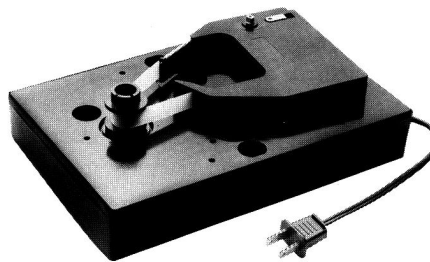

Free bottle of ink, reservoir cover, ink meter and dispenser

\$42.00

MacInker™, the automatic ribbon re-inker. The Imagewriter MacInker (mod 234IM) re-inks Imagewriter I/II black & single color cartridges. The Universal MacInker also re-inks hundreds of different cartridge types (including the Imagewriter LQ) with suitable adaptors. Extra dark, dot matrix, lubricated ink yields a truly better than new print quality and helps extend print-head life. Average number of re-inkings/cartridge is 60-100. With the Multicolor Adaptor (mod M422, \$40.00) your MacInker can re-ink the multicolor Imagewriter II cartridges. We have a full range of optional accessories, inks & cartridges: indelible ink, heat transfer etc. Colors: red, green, blue, yellow, purple, brown, orange, silver, gold. Ask for free catalog.

| | |
|--|----------------------|
| Imagewriter I/II MacInker (mod 234IM)..... | 42.00 |
| Multicolor Adaptor (mod M422)..... | 40.00 |
| Epson MacInker (mod 271EP)..... | 42.00 |
| Universal MacInker..... | 68.50 |
| Imagewriter cartridges.....3.15/ea (qty 6) | 4-color.....10.00/ea |
| ImageWriter LQ cartridges.....14.50/ea | LQ 4 Color.....16.90 |
| Extra Ink bottle.....3.00/ea | plnt.....18.50 |

Data Switches

| | |
|------------------------|--|
| 4 port 8 pin.....50.00 | Autoswitch 2 port ser or par...149.00 |
| 4 port 9 pin.....50.00 | Autoswitch 4 port ser or par...169.00 |
| cable.....16.00 | Full range of cables, switches available |

Order Toll Free (800)547-3303

Computer Friends, Inc., 14250 NW Science Park Dr. Portland OR 97229
tel. (503)626-2291 - fax (503)643-5379

Major credit cards accepted, cod, immediate shipment, 30 days money back guarantee

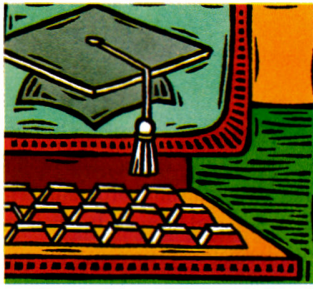

LEARNING CURVE

Belridge uses technology to empower teachers, students, and parents to become more effective learners, more flexible thinkers.

BUILDING A FUTURE

By DAVID THORNBURG

AS THE CITY OF BAKERSFIELD DISAPPEARED in the rear-view mirror, we traveled far into the surrounding countryside. The car bumped its way along rural roads; groves of trees gave way to clusters of derricks, and the odor of crude oil seeped through the closed windows.

I saw a small residential area nearby—McKittrick, California, a company town located in one of the richest oil fields in the country. Next to the cluster of neat homes with their manicured lawns stood the object of my visit, the Belridge School—otherwise known as DACOTT 21/20, a District and Community of Tomorrow Today.

I've had the honor of visiting many technology-intensive schools, but I'd never seen anything like Belridge's universal computer access: Every student in the school has a computer in the classroom and a computer (with printer and modem) at home.

Student desks have transparent tops, to allow computers to be installed inside, with keyboards on pull-out trays for easy access. Most are Apple IIGSes, although there are a number of Macintoshes as well.

In addition, Belridge's Apples are networked. Students work in cooperative-learning groups of four, each with its own printer. The teacher has a separate computer, plus VCR or videodisc player connected to a large-screen monitor so that the whole class can see what's going on.

Technology pervades the entire school. The music room has not only a "real" piano, but a cluster of networked synthesizers as well, which allow the instructor to talk and listen to each student privately, even though several students may be working at the same time. Outside the school building, a satellite dish and antenna let Belridge broadcast on a UHF television channel to each home in the district.

UNLOCKING CREATIVITY

The driving force behind this program is Gary Peterson, district superintendent and principal of Belridge. Peterson and a devoted staff have created an educational oasis in the middle of a desert.

One of the classrooms I visited was set up for thematic instruction. All subjects were being taught around a common theme—the California coast. As I entered the room I could hear the faint sound of waves hitting the shore (from a tape player in one corner). The walls were filled with the beginnings of a "visual database" on marine mammals.

I had the pleasure of engaging this class in a brainstorming session, beginning with the presentation of abstract computer graphics I had synchronized to Debussy's *Girl with the Auburn Hair*. We knew from previous work that a few minutes of synchronized graphics and music can help break down mental blocks to the generation of creative ideas.

As I captured their thoughts on white boards, the kids started writing stories based on their ideas. In the time it would take to find a sheet of paper, they downloaded McGraw-Hill's word processor II Write from the network and were busy composing essays. Because II Write sports a "Mac-style" interface, the students experimented with typeface and page-layout options they wouldn't consider if they were writing by hand. But rather than interfere with the writing process, the computers seemed to be natural tools for them. They approached the technology with an ease that had taken me years to acquire.

Yet, as natural as everything in that classroom appeared, it didn't happen of its own accord.

WHAT'S THE POINT?

Computers have scarcely begun to penetrate our schools. We have more than 45 million elementary, junior-high, and high-school students in this country, but only 2 million classroom machines, most of which are locked away in computer labs. From this small base, it's hard to predict the impact of the technology, but Belridge serves as a model for what education can become.

Computers are so rare in most classrooms that the focus is often more on the technology than on education; by placing computers everywhere, Belridge has allowed the technology to fade into the ►



Sonic Blaster.™ It's why they put the "S" in IIGs.

Sonic Blaster™, the IIG's first full-featured stereo digitizer, brings a new dimension to computing...the element of fun.

Record sounds, tailor them with extensive editing options and play your own amplified versions back through your home stereo speakers. Sonic Blaster automatically digitizes and plays back GS games that use the computer's built-in Ensoniq sound chip (as almost all do), with thundering results.

Kick back with your favorite computer game and immerse yourself in a roomful of sound effects. Create strange answering machine messages. Drop an interesting background sound into your phone conversations (we provide 17 to get you started). Change screen colors with a virtually infinite palette of color.

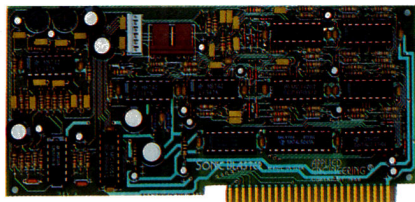

Sonic Blaster's ultra-low-noise digital design is certified by the FCC.

Use your own equipment.

Use the equipment you already have. You don't need special amplified speakers because Sonic Blaster's built-in amplifier works with standard 8 Ohm speakers, small or large, including those monsters next to your stereo. Take sounds from your favorite TV show, album, compact disk, VCR, even a microphone. Then amplify, play backward, create echoes and

fades, cut, copy and paste with the Super Hi-Res software we include.

We designed Sonic Blaster to be complete. Here's a quick tour of part of the software screen:

The Buttons

Stop, Play, Pause and Record buttons, perform the same functions they do on a tape recorder. Also included are Single and Continuous Play buttons and a VU Meter to visually represent input levels.

The Sound Graph

The Sound Graph is the waveform at the bottom of the screen. Portions of the Sound Graph are selected with the mouse and then edited using the cut, copy and paste options within the Edit menu.



Seventeen sound effects to get you started. Add your own collection of sounds.

The Bars

The Volume bar controls amplitude of the playback. Playback and Record mode sample rates are adjusted with the next pair of bars and the Record Level bar adjusts the level from the source connected to the Sonic Blaster's input connector.

The Blocks

Three blocks give readouts of file length, available memory, bytes selected and resolution ratio.

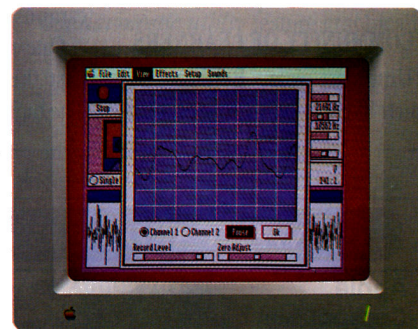

"See" the sound on the oscilloscope.

The Oscilloscope

Sonic Blaster's built-in oscilloscope gives you a real-time display of input sounds. Use it to set your input levels before recording. Or use the Auto Gain feature to adjust the level automatically.

Sonic Blaster

\$129

Order Today!

To order or for more information, see your dealer or call (214) 241-6060 today, 9 am to 11 pm, 7 days. Or send check or money order to Applied Engineering. MasterCard, VISA and C.O.D. welcome. Texas residents add 7% sales tax. Add \$10 outside U.S.A.

AE APPLIED ENGINEERING®

The Apple enhancement experts.

A Division of AE Research Corporation.

(214) 241-6060

P.O. Box 5100, Carrollton, TX 75011

Prices subject to change without notice.

background. Computers there are no more deserving of special attention than books, pencils, or any other educational tool.

Why is the distinction important? The reason for creating a technology-rich environment has little to do with technology itself. The ongoing transformation of our society from an industrial to an information-based economy presents special challenges for education. Belridge made a conscious decision to prepare students for their future, not for our past. The school doesn't see technology as a quick fix for education's problems, but as the next step in the logical movement from the tools of the past to those of the future.

A COMMUNITY OF LEARNERS

Until last year, Belridge was much like any other school in the

country. The Belridge Governing Board started exploring the impact of rapid social change and decided to transform their school in a way that would meet the long-term needs of the students and the town.

Acquiring the technology turned out to be simple. But in addition, the school had to tackle the more complex task of helping educators make the transition to a new kind of teaching—something that required tremendous dedication on the part of the teachers as well as a willingness to take risks and learn new skills. This effort took place in full view of the surrounding town, resulting in a school/community bond that's evident as soon as you step on campus.

One night I stayed at Belridge past the traditional closing time. The building stayed open, and en-

tire families came to school for informal sessions on computer graphics, programming, and any number of other topics.

The students served as teachers for the parents, and it was plain that "continuing education" was something that appealed to everyone—adults and children alike.

IN PERSPECTIVE

When you look at a project like this one, there's always the risk of confusing the tools with the process.

Belridge's goal isn't to "teach" with computers. It sees education as a human task, and recognizes that computers will never replace people in education.

The school is focused on helping students become independent, self-directed learners in a changing world. This belief in education as a lifelong process can be seen

in the students' enthusiasm for their course work, as well as in the spirit of the educators themselves. Their pride comes not from access to technology, but from their ability to develop minds in an atmosphere of trust and support.

A VISION OF EDUCATION

Belridge uses technology to empower teachers, students, and parents to become more effective learners, more flexible thinkers.

There's nothing in this school that can't be replicated in every corner of this country—all it takes is a lot of dedication and a clear vision of just how joyous education can be. □

DAVID THORNBURG IS INVOLVED IN THE CREATIVE USES OF COMPUTERS IN EDUCATION. WRITE TO HIM C/O IN-CIDER, 80 ELM STREET, PETERBOROUGH, NH 03458.

| | | |
|---|--|---|
| PRINTER CARD \$39.95 | II/II+ KEYBOARD \$39.95 | ZIP CHIP \$159.95 |
| <p>Apple Compatible Cards and Products</p>  <p>16K RAM Card (Language Card) for Apple II and II+ • expand from 48K to 64K. JE860.....\$39.95 \$34.95</p> <p>Extended 80-Column Card for Apple IIe. Doubles the display and memory capacity of your Apple IIe. JE864.....\$39.95</p> <p>Disk Drive Controller Card for Apple II, II+, and IIe. Capable of handling 2 drives (including ADD12, right) JE875.....\$49.95 \$34.95</p> <p>Parallel Printer Card for Apple II, II+, and IIe. Compatible with most dot matrix printers. JE880.....\$49.95 \$39.95</p> <p>12" Monochrome Green Monitor for Apple II, II+, IIe & IIc and Laser 128EX. AMON.....\$99.95</p> <p>No-Slot Clock for Apple IIe, IIc and IIGS. Plugs directly into your motherboard • 10 year battery. IB137.....\$44.95</p> <p>Laser 5.25" Half Height Disk Drives for Apple II, II+, IIe and IIc</p>  <ul style="list-style-type: none"> • Direct drive • 160K storage • 40 tracks • Super quiet • Works with Apple Controllers or other Apple compatible controllers (JE875, see above) • Complete with connector • just plug into your controller <p>ADD12 Disk Drive (for II, II+ and IIe).....\$99.95 ADD2C Disk Drive - no controller needed (for IIc).....\$99.95 AAM Adapts standard Apple drives for use with IIc \$4.95</p> | <p>Apple II/II+ Compatible Enhanced Keyboard and Case</p>  <p>Features: • Cursor control/numeric keypad • Predefined function keys (Applesoft) • 68 keys with 15-key keypad • Direct connection to motherboard with 16-pin DIP jumper • Pop-up lid for easy access to motherboard and power supply • Fits original Apple II/II+ motherboard and power supply • Color: Beige with brown/grey keys</p> <p>AEKB.....\$69.95 \$49.95</p> <p style="text-align: center;">Apple II, II+ and IIe Replacement Keyboards</p>  <p>Keyboard features: • Apple II/II+ and IIe compatible replacements available • Includes Cursor Control (AKB2E only) • Keyboards feature all the same keys as the original II/II+ and IIe • Software Compatible</p> <p>AKB Apple II/II+ Replacement Keyboard \$39.95 AKB2E Apple IIe Replacement Keyboard...\$44.95</p> <p style="text-align: center;">Apple Cable Assemblies</p> <p>APC2 Apple to Imgwtr. or GS/Mac to Modem Cable. \$4.95 APC3 Apple IIGS/Mac to Imgwtr. or LsrWtrr. Cable.. \$4.95 APC4 Apple IIGS/Mac Adapter Cable.....\$7.95 MAC1 Apple II/II+ IIe IIGS to ImageWriter Cable.....\$5.95 RCA10RCA Composite Monitor/Audio RCA Cable.....\$1.95</p> | <p>Apple ZIP CHIP Increase the Speed of Your Apple up to 400% • Apple II, II+, IIe and IIc compatible • Replaces the microprocessor • Gives you the equivalent speed of an IBM AT • Addresses all Apple memory • Runs all Apple compatible software • Manual included • Lifetime Warranty</p> <p>ZIP CHIP for Apple II, II+, IIe & IIc.....\$159.95</p> <p style="text-align: center;">2400/1200/300 Baud External Modems for Apple II, II+, IIe, IIc and IIGS</p>  <ul style="list-style-type: none"> • Hayes command compatible • Bell 103/212A compatible • Auto-dial/auto-answer • Auto sense set-up • FCC approved • 1-yr. warranty • Software not included • Serial card needed for operation excluding IIGS (See AP140, below) <p>1200C 1200/300 Baud Ext. Modem.....\$99.95 2400C 2400/1200/300 Baud Ext. Modem.....\$169.95 AP140 Super Serial Card for Apple II, II+ & IIe.....\$69.95</p> <p style="text-align: center;">Zoom 300 Baud Modems</p>  <p>for Apple II, II+ and IIe ZM300</p> <ul style="list-style-type: none"> • Hayes compatible • ZOOM communications software included • Two-year Warranty <p>NM300 Manual Dial/Manual Answer Modem.....\$19.95 ZM300 Auto dial/Auto Answer Modem.....\$49.95 NMS Software Enhancement.....\$19.95</p> <p style="text-align: center;">Apple Cooling Fan</p> <p>• For Apple II, II+ and IIe • Line surge suppression • Snaps on the side</p> <p>APF.....\$29.95</p> <p style="text-align: center;">Switching Power Supply</p> <p>• For Apple II, II+ and IIe • 110V/220V • +5 @ 5A, +12 @ 2.5A, -5 @ 5A, -12 @ 5A</p> <p>KHP4007.....\$44.95</p> |
| <p>1355 SHOREWAY ROAD BELMONT, CALIFORNIA 94002 24 HR. ORDER HOTLINE (415) 592-8097 Telex #176043 FAX (415) 592-2503 CUSTOMER SERVICE 7AM-5PM PST (415) 592-8121</p> | <p>MasterCard</p> <p>VISA</p> | <p>Mail Order Electronics - Worldwide</p> <p>Jameco ELECTRONICS</p> <p>15th ANNIVERSARY 1974 - 1989</p> |

RamKeeper™ If not the first board you add to your IIGS

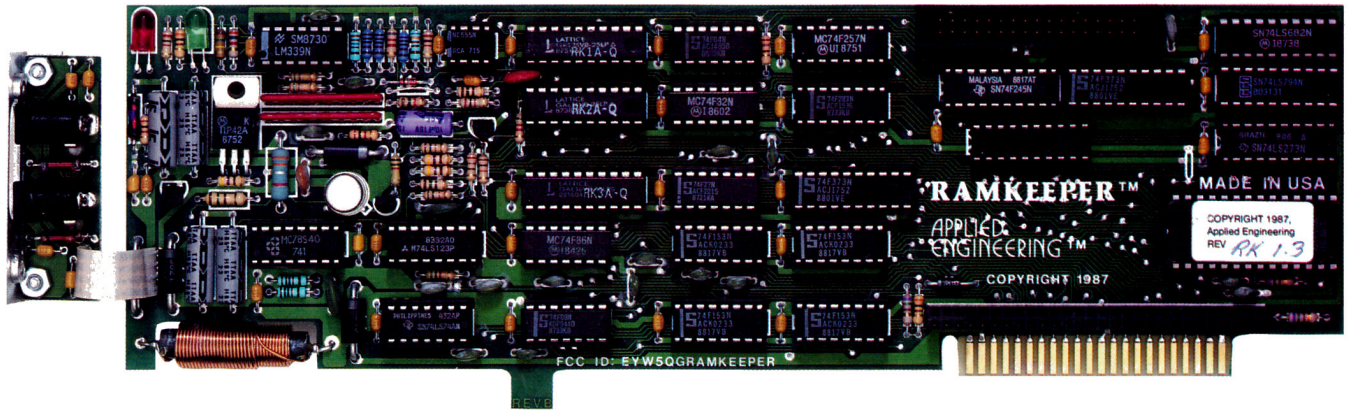

Certainly the second.

Chances are the first board you add to your computer will be for memory expansion. RamKeeper™ makes a smart second addition by performing *two important tasks*:

First, it gives you a sensible way to grow beyond the Apple memory expansion board that probably came with your IIGS. Apple's board has room for only 1 MEG of memory, and the new, integrated programs need a MEG just to boot.

RamKeeper lets you add a second memory board to your memory expansion slot with a special "back pocket" connector. That way, you can use your 1 MEG Apple board and still expand beyond its 1 MEG limit. And RamKeeper "sees" the two boards as one, so all you'll notice is the increased memory.

Second, RamKeeper creates battery-backed Ram and ROM. Safely store your system software, often-used application programs and most-needed files on RamKeeper-enabled ROM. It's like an internal, electronic hard disk (up to 16 MEG!), but five times faster than an ordinary hard disk.

Turn your computer on and see the finder in 13 seconds, instead of several minutes.

Safe storage

RamKeeper powers up to two memory boards simultaneously, even when your computer is turned off. What's more, the stored programs are protected against power outages by the reliable Gel/Cell battery we include. Startup checksums are employed to verify that no data was lost

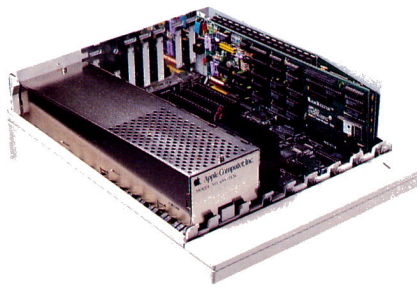

RamKeeper is easy to install and stores programs in an "instant on" electronic hard disk.

while the power was off. To protect the operating software against program crashes, we installed RamKeeper's controlling firmware in an EPROM.

You can even mix different brands of boards. For example, an Apple board with at least 512K of memory (based on 256K x 1 chips), and AE's (MEG-chip based) GS-RAM Plus™ or GS-RAM Ultra™ boards. And most all other brand and size combinations are also possible.

Advanced enough to be easy

We designed RamKeeper to be easy to use. Instructions are clear and most functions are automatic. For example, there's no need to manually configure if you add a second board, it's done automatically. The configuring is linear, so there's less chance of a program crash. And *you* decide how much memory to devote to ROM and to RAM—all without affecting your stored files.

Compare features:

RamKeeper includes a collection of important features like *disk caching* that

tremendously accelerates access time to the 3.5 drive, running most applications up to *seven times faster*.

Our *diagnostic utility* feature graphically detects the presence of bad or improperly-installed chips and tests for CAS before RAS chips.

And RamKeeper features Applied Engineering's meticulous craftsmanship, 5-year warranty, 15-day money-back guarantee* and our American-made pride.

Use AppleWorks?

AppleWorks users will find another bonus. Our AppleWorks enhancement package dramatically increases AppleWorks word processor lines from 7,250 to 22,500. Database records are increased from 6,350 to 22,500 and clipboard capacity climbs from 255 lines to 2,042.

RamKeeper \$189

Order today!

To order or for more information, see your dealer or call (214) 241-6060 today, 9 am to 11 pm, 7 days. Or send check or money order to Applied Engineering, MasterCard, VISA and C.O.D. welcome. Texas residents add 7% sales tax. Add \$10 outside U.S.A.

AE APPLIED ENGINEERING®

The Apple enhancement experts.

A Division of AE Research Corporation.

(214) 241-6060

P.O. Box 5100, Carrollton, TX 75011

Prices subject to change without notice. Brands and product names are registered trademarks of their respective holders.

*When purchased from Applied Engineering or thru a participating dealer.



**MACE ON
GAMES**

DELICATE BALANCE

By **SCOTT MACE**

Two thrilling new current-events games simulate the dynamics of military and diplomatic conflict.

FUTURISTIC GAMES PIT YOU AGAINST THE netherworld of dragons and wizards; current-events games keep you firmly rooted in the here and now. Of course you can't simulate the entire world on your Apple II; although they depict realistic conditions, these games are limited by the computer's ability or the designer's imagination.

Two software companies have designed thrilling new world-events games by simplifying their objectives, however. Leisure Genius' **Risk** (711 West 17th Street, Costa Mesa, CA 92627, 714-631-1001, \$39.99) and Mindscape's **Balance of Power: The 1990 Edition** (3444 Dundee Road, Northbrook, IL

marily an entertaining social interaction, however, **Balance of Power** provokes a deep examination of today's geopolitical stakes.

WORTH THE RISK

Risk stretches the Apple II in new directions. Its map of six continents divided into 42 countries is displayed on a wraparound screen that scrolls rapidly in either direction. A "view world" option lets you see all six continents at once. Because your Apple II can't display all 46 countries' names, the scrolling map is a necessity.

The game's objective is straightforward—you're out to conquer the world. It's a military-strategy game, and you'd better plan your troop deployment carefully or you'll wind up boxed in and prey to your foe. Two to six players start out with an equal number of countries (which either the computer or each player chooses) and armies. A simulated throw of the dice resolves every conflict. The game matches the attacker's highest roll against the defender's highest toss, then deducts the defeated armies automatically.

Although it's not dramatically different from the Parker Brothers board game, **Risk** makes for good computer entertainment. Its map and rules are similar to those of the original board version, and you can redeem simulated "cards" won during conquest for extra armies. **Risk** fans will love the new

optional playing parameters. For example, if you have more than 12 armies in any territory, you must redeploy them or you'll lose your extra troops.

PERFECT BALANCE

When you take global gaming to the Apple IIGs, you'll notice immediately that you can display many ▶

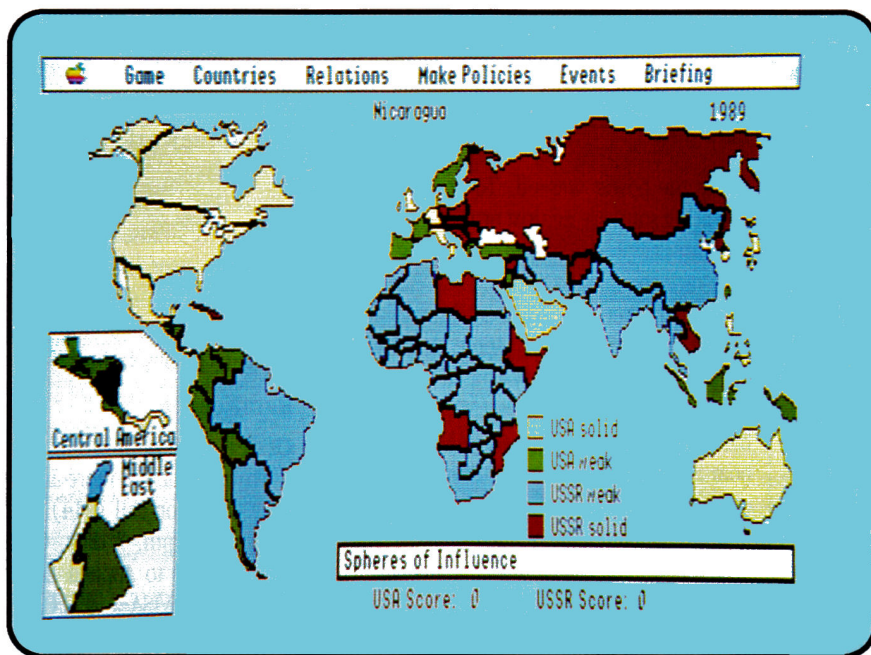

Balance of Power: a deep examination of today's geopolitical stakes.

60062, 312-480-7667, \$49.95; see Editors' Choice, "Lessons for the Nuclear Age," June 1989, p. 148) represent the current leaders among Apple II world-building games.

Both games do far more than place countries on an electronic map—they simulate the dynamics of military and diplomatic conflict. While **Risk** is pri-

THEY'RE BACK!



ON A COMPUTER NEAR YOU

| | IBM | APPLE II | MAC | C64 | AMIGA | ATARI ST |
|------------------------------|---------|----------|---------|---------|---------|----------|
| SCRABBLE | \$39.99 | \$39.99 | \$39.99 | \$29.99 | \$39.99 | \$39.99 |
| MONOPOLY | \$39.99 | DEC | | \$29.99 | \$39.99 | \$39.99 |
| RISK | \$39.99 | \$39.99 | \$39.99 | \$29.99 | \$39.99 | \$39.99 |
| CLUE MASTER DETECTIVE | \$39.99 | \$39.99 | | \$29.99 | \$39.99 | \$39.99 |



Distributed by:- VIRGIN MASTERTRONIC INTERNATIONAL Inc.
 711 West 17th Street, Suite G9, Costa Mesa, California 92627 U.S.A.
 Telephone (714) 631-1001 Telefax (714) 631-1004



Save \$5.00 or More by Pre-registering Now

AppleFest'89 San Francisco

Discover How to Make the Most of Your Apple® Computer!

September 22-24, 1989

Brooks Hall / Civic Auditorium

San Francisco, California



It's the ultimate experience for Apple users — and prospective users. The all-new AppleFest®'89, at San Francisco's Brooks Hall and Civic Auditorium, September 22-24, 1989. Bigger and more exciting than ever, with more than 200 companies exhibiting the latest

products for Apple II and Macintosh® computers.

There's more. Aside from all of the good things AppleFest '89 will do for your mind, registering right now will do something great for your wallet. You can save \$5, \$30 . . . even more, off of the regular

admission price if you register now. This is your best chance to get the scoop on the hottest new Apple II and Macintosh products and applications. Like AppleWorks GS. HyperMedia. Desktop publishing and presentations. Using Apple computers in multi-media. And much, much more.

AppleFest '89. There's only one thing smarter than deciding to be there.

Deciding now.

Call 1-800-262-FEST to order tickets or for more information. (In Massachusetts, call 617-860-7100.) Remember: act today, to receive the advance registration savings.

more countries on screen. Balance of Power: The 1990 Edition features 80 nations. I recommend using an accelerator, though, because a plain-vanilla GS will spend a few minutes drawing those 80 countries on screen.

The conflicts in Balance of Power are diplomatic rather than military. The original game involved the United States versus the Soviet Union, a so-called *bipolar* simulation. The more advanced options included in the 1990 Edition are *multipolar*.

THIRD WORLD

The program now gives each country independent attitudes (such as being fully allied with or merely sympathetic to either of the two major powers) that affect its reaction to world events.

No longer is every country just a pawn of the U.S. or the U.S.S.R. This realistic simulation makes the game much more difficult—and enjoyable.

If a nuclear war breaks out, even accidentally, both sides lose. Balance of Power provides no scenario in which either side is completely victorious.

Rather, the winner of a given game is likely to be the side that gains the most prestige by facing down the opponent during a diplomatic crisis.

STAY COOL

During these critical times you're not alone. Four advisers counsel you by assessing your chances of bluffing past your opponent.

Clearly, it isn't easy to reduce the actions of 80 countries to a computer program, but Balance of Power is as close to global reality as we're likely to get on the Apple II.

PLUS AND MINUS

In both games, forcing players to deal with limited resources is both an asset and a handicap. Risk concentrates on armies; Balance of Power focuses on limited funds

for foreign aid.

The plus is that both games play fairly quickly, as conflicts inevitably come to a head as soon as you've deployed your armies or expended your funds.

The disadvantage is these simulations miss out on nations' military and economic vitality. Risk misses the natural escalation of armies that has marked modern history; Balance of Power glosses over nations being able to borrow billions to build their might.

Consequently, these games don't represent the ultimate global conflict. Yes, Balance of Power is especially rich in geopolitical details, and Risk is great fun. You can play as a benevolent participant or as a ruthless warmonger.

**WORLD CLASS:
MICROCOSMS ON SCREEN**

Balance of Power's prestige rating, which measures your achievement in the game, suggests that someday computers will be able to capture the nuances of human interaction. Reducing all those nuances to choices on a menu or in a dialog box, however, should invite some hoots from real geopoliticians.

For now, let them hoot. We've come a long way from the early days of Apple II gaming. Computers can capture whole micro-worlds with increasingly vivid details, making games all the more exciting and challenging.

The mere video game, although seemingly immortal, pales in comparison to the computer simulations of today. The Apple II can be proud to have played such a pivotal role. □

SCOTT MACE IS EDITOR AND PUBLISHER OF *MICROCOSM*, A MONTHLY NEWSLETTER ON COMPUTER GAMES. WRITE TO HIM AT 9350F SNOWDON RIVER PARKWAY, SUITE 277, COLUMBIA, MD 21045-5260. ENCLOSE A STAMPED, SELF-ADDRESSED ENVELOPE IF YOU'D LIKE A PERSONAL REPLY.

GET ON THE FAS-TRACK!



Call us for your FREE 1989 School and Home Computer Products Catalog—More than 100 pages of software, hardware and accessories.

DISCOUNTS UP TO 45% EVERYDAY!

Laser 128EX Computer System with RGB Monitor

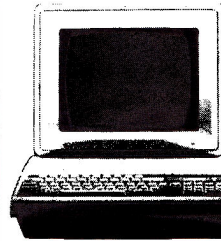

\$699.95



\$449.95

Laser 128EX

\$379.95

Laser 128

- Three Times Faster than Apple IIe
- 128K Ram (expandable to 1 Meg)
- Built-in Disk Drive
- Free Shipping!
- Much More!

Laser Extras

- Laser 190A Printer \$199.95
- FD 100 Apple Compatible Drives \$99.95
- FD 356 3.5" 800K Drive \$199.95
- Laser Mouse \$59.95

- 256K Drums (set of 8) \$75
- 1 Meg Drums (set of 8) \$175

Productivity Software

- AppleWorks 2.1 \$184.95
- AppleWorks GS \$199.95
- Copy II Plus \$23.95

Desktop Publishing & Graphics

- Publish It! 2 \$74.95
- 4 in one Graphics Pack \$79.95
- Childrens' Writing and Pub Center \$36.95
- Print Shop \$28.95
- Print Shop IIgs \$36.95
- VCR Companion \$29.95
- Print Shop Lovers Utility Set \$25.95
- Labels, Labels, Labels \$25.95

Applied Engineering

- GS Ram Plus w/1 Meg \$349.95
- RamKeeper \$149.95
- TransWarp IIgs \$304.95
- Sonic Blaster \$104.95
- RamWorks III w/256K \$189.95

Accessories

- ImageWriter Black Ribbon \$2.95
- ImageWriter 4-Color Ribbon \$6.95
- 10 DS/DD 3.5" Bulk Diskettes \$11.95
- 25 DS/DD 5.25" Bulk Diskettes \$9.95
- 5.25" Disk Case (Holds 60) \$7.45
- 3.5" Disk Case (Holds 40) \$7.45
- System Saver IIgs \$75.95



TimeOut Series

- QuickSpell, Superfonts, Telecomm \$37.95
- GS Font Editor \$28.45
- Thesaurus or Powerpack ea \$28.45
- Desktools I or II ea \$28.45
- Sidespread or File Master \$28.45
- Spreadtools or Ultramacros ea \$34.45
- Macrotools I or II ea \$14.95
- Graph or ReportWriter ea \$47.95

Entertainment

- Test Drive II—The Dual (IIgs) \$29.95
- Jack Nicklaus Golf (IIgs) \$29.95
- California Games (IIe or IIgs) ea \$26.95
- Kings Quest IV (IIe or IIgs) ea \$33.95
- War in Middle Earth (IIgs) \$33.95
- Wheel of Fortune 1, 2 or 3 ea \$9.95
- Jeopardy 1, 2 or Sports Edition ea \$9.95
- Chessmaster 2100 (IIgs) ea \$34.95
- Arkanoid (IIe or IIgs) \$20.95
- Mean 18 or Hardball (IIgs) ea \$31.95

Other Hardware

- Apple IIe 80 Column 64K Card \$34.95
- Kraft KCIII Joystick \$19.95
- Zip Chip 4mhz \$119.00
- Zip Chip 8mhz \$169.00
- Zip IIgs \$245.00
- Computer Eyes for IIgs \$209.95
- Thunderscan \$187.95
- FingerPrint GSI \$84.95

**Fas-Track
Computer Products**

7030C Huntley Road • Columbus, Ohio 43229

ALWAYS CALL **1-800-272-1600**

TOLL-FREE

1-800-438-1168 (Ohio)



1-614-847-4050 (Central Ohio)

U.S., F.P.O., and A.P.O., add 3% (minimum \$3.00) for each shipment. No C.O.D. In Ohio, add 5.5% Sales Tax. MasterCard and VISA—No extra charge. We accept purchase orders from schools, universities and other qualified organizations.

FROM HOME TO SCHOOL AND BACK AGAIN, FAS-TRACK DELIVERS!



V VIDEO MAGIC

Apple users know there's always an easier way to get the job done. A shortcut here, an elegant twist there—that's what Hints & Techniques is all about.

It's an information swap for readers who want to share their programming pointers, hardware secrets, AppleWorks applications, and all kinds of other insights.

NOTCH FILTER

By Bruce Jordan

MANY ARTISTS AND ANIMATORS are thrilled by the Apple IIGS' exciting RGB (red-green-blue) graphics capabilities. Unless you're willing to copy scores of disks or drag your GS around town, though, no one but you will ever appreciate the full, glorious color and detail of your designs.

Here's a brainstorm—why not copy your art with a videocassette recorder? That way anyone with a VCR (and there are a lot more VCRs than GSes!) can see your work. But hook up the composite output to your VCR, bring up your art, and all you see are messy colors. Try adjusting your television, and you still have a rainbow effect running wildly across the screen. What happened?

RGB is a very efficient, precise way to send and display video information. Your television and VCR don't use RGB format, though. Instead, they use a composite-video standard known as NTSC (National Television System Committee). The video information in NTSC format isn't as precise as RGB, and much of a picture's clarity is lost in the conversion process.

Why? Composite video transmits picture information via two separate electronic signals, hence the term *composite*. The first signal carries the *chroma*, or color, information for all

three hues, rather than separately as in RGB video. The second signal carries the *luminescence*, or brightness, information. Your picture loses its clarity when the chroma and luminescence signals overlap partially, creating a third signal your TV interprets as random color information. What you see on screen is your television trying to put random colors everywhere.

The solution to the RGB-to-NTSC conversion problem is simple: Remove the chroma/luminescence overlap with an electronic device known as a *notch filter*. It's a very selective

"gate" that lets signals pass through only if they're either above or below a particular "tuned" frequency, as shown in **Figure 1**. The overlap frequency in the GS' RGB-to-NTSC conversion occurs at approximately 3.58 megahertz. Surprisingly, a 3.58-megahertz notch filter is simple in design, inexpensive, and easy to construct.

According to the schematic in **Figure 2**, the circuit consists of eight commonly available parts (see the accompanying **Table**), and is powered by two nine-volt batteries. Capacitor 1 (C1), choke 1 (L1), and trimmer potentiometer (or *pot*) 1 (R1) make up the actual filter section you tune to 3.58 Mhz.

The rest of the circuit is a compensating amplifier, consisting of resistors R2 through R4 and an operational amplifier. Because no filter is perfectly selective, some of the composite signal's desired parts will be attenuated, or reduced. The amplifier's job is to boost the weakened signal back up to normal strength.

You can assemble the circuit on a breadboard, wire-wrap, or printed current card. ►

| | |
|-----------------------|--|
| R1 | 20K Ω 15-turn trimmer potentiometer |
| R2 | 10K Ω 15-turn trimmer potentiometer |
| R3 | 100K Ω 15-turn trimmer potentiometer |
| R4 | 1K Ω carbon resistor |
| L1 | 14–28 μ h adjustable-core choke |
| C1 | 100pf ceramic capacitor |
| IC1 | LM6316 operational amplifier (National Semiconductor) |
| B1, B2 | 9VDC batteries |
| OPTIONAL PARTS | |
| S1 | DPDT switch |
| P1 | 5VDC red LED |
| R5 | 2K Ω carbon resistor |
| J1, J2 | RCA-type jacks 16-pin DIN socket battery clips and holders metal case |

Table. Parts list.

Free

Want To Know More

About Products Or Services Advertised In This Issue?

HERE'S HOW.



• **PRINT** your name and address where indicated.

• **TELL US** about yourself by answering the questions.

• **CIRCLE** the numbers on the card corresponding to the reader service number for products or services that interest you.

• **TEAR OUT** and mail the card—the postage is on us.

• **SUBSCRIBE** to *inCider* by checking off the where indicated. We'll bill you \$27.97 for 12 issues of *inCider* delivered to you monthly. **That's 40% off the cover price.** Look for your subscription in 6 to 8 weeks.

NO OBLIGATION. Literature on products and services will be sent to you directly from advertisers, free of charge.

Product Info

DIRECT TO YOU
at no cost or obligation

INCIDER READER SERVICE CARD

JULY ISSUE, valid until September 15, 1989

Name _____ Phone () _____
Title _____
Address _____
City/State/Zip _____

Check here to start your subscription to *inCider*. You will be billed \$27.97 for one year (12 issues).

Please indicate which of the following computers you currently own and/or plan to buy in the next 3 months.

| | | |
|--------------------|----------------------------|----------------------------|
| | Own | Plan to Buy |
| Apple IIs | <input type="checkbox"/> a | <input type="checkbox"/> f |
| Apple IIc/IIc Plus | <input type="checkbox"/> b | <input type="checkbox"/> g |
| Other Apple IIs | <input type="checkbox"/> c | <input type="checkbox"/> h |
| Laser 128 | <input type="checkbox"/> d | <input type="checkbox"/> i |
| Mac | <input type="checkbox"/> e | <input type="checkbox"/> j |

Please indicate which of the following you plan to buy in the next 3 months.

| | | | |
|-------------------|----------------------------|-----------------------------|----------------------------|
| Additional Memory | <input type="checkbox"/> k | Personal Financial Software | <input type="checkbox"/> n |
| Hard Drive | <input type="checkbox"/> l | Entertainment Software | <input type="checkbox"/> o |
| On-Line Service | <input type="checkbox"/> m | Educational Software | <input type="checkbox"/> p |

How long have you owned your computer?

| | | |
|----------------------------|----------------------------|----------------------------|
| Less than 1 yr | 1-2 yrs | More than 2 yrs |
| <input type="checkbox"/> q | <input type="checkbox"/> r | <input type="checkbox"/> s |

| | | | | | | | | | | | | | | | | | | | | | | | | | | | | | |
|----|----|----|----|----|-----|-----|-----|-----|-----|-----|-----|-----|-----|-----|-----|-----|-----|-----|-----|-----|-----|-----|-----|-----|-----|-----|-----|-----|-----|
| 1 | 6 | 11 | 16 | 21 | 76 | 81 | 86 | 91 | 96 | 151 | 156 | 161 | 166 | 171 | 226 | 231 | 236 | 241 | 246 | 301 | 306 | 311 | 316 | 321 | 376 | 381 | 386 | 391 | 396 |
| 2 | 7 | 12 | 17 | 22 | 77 | 82 | 87 | 92 | 97 | 152 | 157 | 162 | 167 | 172 | 227 | 232 | 237 | 242 | 247 | 302 | 307 | 312 | 317 | 322 | 377 | 382 | 387 | 392 | 397 |
| 3 | 8 | 13 | 18 | 23 | 78 | 83 | 88 | 93 | 98 | 153 | 158 | 163 | 168 | 173 | 228 | 233 | 238 | 243 | 248 | 303 | 308 | 313 | 318 | 323 | 378 | 383 | 388 | 393 | 398 |
| 4 | 9 | 14 | 19 | 24 | 79 | 84 | 89 | 94 | 99 | 154 | 159 | 164 | 169 | 174 | 229 | 234 | 239 | 244 | 249 | 304 | 309 | 314 | 319 | 324 | 379 | 384 | 389 | 394 | 399 |
| 5 | 10 | 15 | 20 | 25 | 80 | 85 | 90 | 95 | 100 | 155 | 160 | 165 | 170 | 175 | 230 | 235 | 240 | 245 | 250 | 305 | 310 | 315 | 320 | 325 | 380 | 385 | 390 | 395 | 400 |
| 26 | 31 | 36 | 41 | 46 | 101 | 106 | 111 | 116 | 121 | 176 | 181 | 186 | 191 | 196 | 251 | 256 | 261 | 266 | 271 | 326 | 331 | 336 | 341 | 346 | 401 | 406 | 411 | 416 | 421 |
| 27 | 32 | 37 | 42 | 47 | 102 | 107 | 112 | 117 | 122 | 177 | 182 | 187 | 192 | 197 | 252 | 257 | 262 | 267 | 272 | 327 | 332 | 337 | 342 | 347 | 402 | 407 | 412 | 417 | 422 |
| 28 | 33 | 38 | 43 | 48 | 103 | 108 | 113 | 118 | 123 | 178 | 183 | 188 | 193 | 198 | 253 | 258 | 263 | 268 | 273 | 328 | 333 | 338 | 343 | 348 | 403 | 408 | 413 | 418 | 423 |
| 29 | 34 | 39 | 44 | 49 | 104 | 109 | 114 | 119 | 124 | 179 | 184 | 189 | 194 | 199 | 254 | 259 | 264 | 269 | 274 | 329 | 334 | 339 | 344 | 349 | 404 | 409 | 414 | 419 | 424 |
| 30 | 35 | 40 | 45 | 50 | 105 | 110 | 115 | 120 | 125 | 180 | 185 | 190 | 195 | 200 | 255 | 260 | 265 | 270 | 275 | 330 | 335 | 340 | 345 | 350 | 405 | 410 | 415 | 420 | 425 |
| 51 | 56 | 61 | 66 | 71 | 126 | 131 | 136 | 141 | 146 | 201 | 206 | 211 | 216 | 221 | 276 | 281 | 286 | 291 | 296 | 351 | 356 | 361 | 366 | 371 | 426 | 431 | 436 | 441 | 446 |
| 52 | 57 | 62 | 67 | 72 | 127 | 132 | 137 | 142 | 147 | 202 | 207 | 212 | 217 | 222 | 277 | 282 | 287 | 292 | 297 | 352 | 357 | 362 | 367 | 372 | 427 | 432 | 437 | 442 | 447 |
| 53 | 58 | 63 | 68 | 73 | 128 | 133 | 138 | 143 | 148 | 203 | 208 | 213 | 218 | 223 | 278 | 283 | 288 | 293 | 298 | 353 | 358 | 363 | 368 | 373 | 428 | 433 | 438 | 443 | 448 |
| 54 | 59 | 64 | 69 | 74 | 129 | 134 | 139 | 144 | 149 | 204 | 209 | 214 | 219 | 224 | 279 | 284 | 289 | 294 | 299 | 354 | 359 | 364 | 369 | 374 | 429 | 434 | 439 | 444 | 449 |
| 55 | 60 | 65 | 70 | 75 | 130 | 135 | 140 | 145 | 150 | 205 | 210 | 215 | 220 | 225 | 280 | 285 | 290 | 295 | 300 | 355 | 360 | 365 | 370 | 375 | 430 | 435 | 440 | 445 | 450 |

INCIDER READER SERVICE CARD

JULY ISSUE, valid until September 15, 1989

Name _____ Phone () _____
Title _____
Address _____
City/State/Zip _____

Check here to start your subscription to *inCider*. You will be billed \$27.97 for one year (12 issues).

Please indicate which of the following computers you currently own and/or plan to buy in the next 3 months.

| | | |
|--------------------|----------------------------|----------------------------|
| | Own | Plan to Buy |
| Apple IIs | <input type="checkbox"/> a | <input type="checkbox"/> f |
| Apple IIc/IIc Plus | <input type="checkbox"/> b | <input type="checkbox"/> g |
| Other Apple IIs | <input type="checkbox"/> c | <input type="checkbox"/> h |
| Laser 128 | <input type="checkbox"/> d | <input type="checkbox"/> i |
| Mac | <input type="checkbox"/> e | <input type="checkbox"/> j |

Please indicate which of the following you plan to buy in the next 3 months.

| | | | |
|-------------------|----------------------------|-----------------------------|----------------------------|
| Additional Memory | <input type="checkbox"/> k | Personal Financial Software | <input type="checkbox"/> n |
| Hard Drive | <input type="checkbox"/> l | Entertainment Software | <input type="checkbox"/> o |
| On-Line Service | <input type="checkbox"/> m | Educational Software | <input type="checkbox"/> p |

How long have you owned your computer?

| | | |
|----------------------------|----------------------------|----------------------------|
| Less than 1 yr | 1-2 yrs | More than 2 yrs |
| <input type="checkbox"/> q | <input type="checkbox"/> r | <input type="checkbox"/> s |

| | | | | | | | | | | | | | | | | | | | | | | | | | | | | | |
|----|----|----|----|----|-----|-----|-----|-----|-----|-----|-----|-----|-----|-----|-----|-----|-----|-----|-----|-----|-----|-----|-----|-----|-----|-----|-----|-----|-----|
| 1 | 6 | 11 | 16 | 21 | 76 | 81 | 86 | 91 | 96 | 151 | 156 | 161 | 166 | 171 | 226 | 231 | 236 | 241 | 246 | 301 | 306 | 311 | 316 | 321 | 376 | 381 | 386 | 391 | 396 |
| 2 | 7 | 12 | 17 | 22 | 77 | 82 | 87 | 92 | 97 | 152 | 157 | 162 | 167 | 172 | 227 | 232 | 237 | 242 | 247 | 302 | 307 | 312 | 317 | 322 | 377 | 382 | 387 | 392 | 397 |
| 3 | 8 | 13 | 18 | 23 | 78 | 83 | 88 | 93 | 98 | 153 | 158 | 163 | 168 | 173 | 228 | 233 | 238 | 243 | 248 | 303 | 308 | 313 | 318 | 323 | 378 | 383 | 388 | 393 | 398 |
| 4 | 9 | 14 | 19 | 24 | 79 | 84 | 89 | 94 | 99 | 154 | 159 | 164 | 169 | 174 | 229 | 234 | 239 | 244 | 249 | 304 | 309 | 314 | 319 | 324 | 379 | 384 | 389 | 394 | 399 |
| 5 | 10 | 15 | 20 | 25 | 80 | 85 | 90 | 95 | 100 | 155 | 160 | 165 | 170 | 175 | 230 | 235 | 240 | 245 | 250 | 305 | 310 | 315 | 320 | 325 | 380 | 385 | 390 | 395 | 400 |
| 26 | 31 | 36 | 41 | 46 | 101 | 106 | 111 | 116 | 121 | 176 | 181 | 186 | 191 | 196 | 251 | 256 | 261 | 266 | 271 | 326 | 331 | 336 | 341 | 346 | 401 | 406 | 411 | 416 | 421 |
| 27 | 32 | 37 | 42 | 47 | 102 | 107 | 112 | 117 | 122 | 177 | 182 | 187 | 192 | 197 | 252 | 257 | 262 | 267 | 272 | 327 | 332 | 337 | 342 | 347 | 402 | 407 | 412 | 417 | 422 |
| 28 | 33 | 38 | 43 | 48 | 103 | 108 | 113 | 118 | 123 | 178 | 183 | 188 | 193 | 198 | 253 | 258 | 263 | 268 | 273 | 328 | 333 | 338 | 343 | 348 | 403 | 408 | 413 | 418 | 423 |
| 29 | 34 | 39 | 44 | 49 | 104 | 109 | 114 | 119 | 124 | 179 | 184 | 189 | 194 | 199 | 254 | 259 | 264 | 269 | 274 | 329 | 334 | 339 | 344 | 349 | 404 | 409 | 414 | 419 | 424 |
| 30 | 35 | 40 | 45 | 50 | 105 | 110 | 115 | 120 | 125 | 180 | 185 | 190 | 195 | 200 | 255 | 260 | 265 | 270 | 275 | 330 | 335 | 340 | 345 | 350 | 405 | 410 | 415 | 420 | 425 |
| 51 | 56 | 61 | 66 | 71 | 126 | 131 | 136 | 141 | 146 | 201 | 206 | 211 | 216 | 221 | 276 | 281 | 286 | 291 | 296 | 351 | 356 | 361 | 366 | 371 | 426 | 431 | 436 | 441 | 446 |
| 52 | 57 | 62 | 67 | 72 | 127 | 132 | 137 | 142 | 147 | 202 | 207 | 212 | 217 | 222 | 277 | 282 | 287 | 292 | 297 | 352 | 357 | 362 | 367 | 372 | 427 | 432 | 437 | 442 | 447 |
| 53 | 58 | 63 | 68 | 73 | 128 | 133 | 138 | 143 | 148 | 203 | 208 | 213 | 218 | 223 | 278 | 283 | 288 | 293 | 298 | 353 | 358 | 363 | 368 | 373 | 428 | 433 | 438 | 443 | 448 |
| 54 | 59 | 64 | 69 | 74 | 129 | 134 | 139 | 144 | 149 | 204 | 209 | 214 | 219 | 224 | 279 | 284 | 289 | 294 | 299 | 354 | 359 | 364 | 369 | 374 | 429 | 434 | 439 | 444 | 449 |
| 55 | 60 | 65 | 70 | 75 | 130 | 135 | 140 | 145 | 150 | 205 | 210 | 215 | 220 | 225 | 280 | 285 | 290 | 295 | 300 | 355 | 360 | 365 | 370 | 375 | 430 | 435 | 440 | 445 | 450 |

Free Product

DIRECT TO YOU
at no cost or obligation



BUSINESS REPLY MAIL
FIRST-CLASS MAIL PERMIT NO. 1217 BOULDER, CO

POSTAGE WILL BE PAID BY ADDRESSEE

inCider
ATTN: Reader Service Dept.
P.O. Box 8987
Boulder, CO 80328-8987

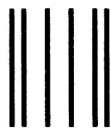

BUSINESS REPLY MAIL
FIRST-CLASS MAIL PERMIT NO. 1217 BOULDER, CO

POSTAGE WILL BE PAID BY ADDRESSEE

inCider
ATTN: Reader Service Dept.
P.O. Box 8987
Boulder, CO 80328-8987



NO POSTAGE
NECESSARY
IF MAILED
IN THE
UNITED
STATES



NO POSTAGE
NECESSARY
IF MAILED
IN THE
UNITED
STATES



Info

**Want To
Know More**
About Products Or
Services Advertised In
This Issue?

HERE'S HOW.



- **PRINT** your name and address where indicated.
- **TELL US** about yourself by answering the questions.
- **CIRCLE** the numbers on the card corresponding to the reader service number for products or services that interest you.
- **TEAR OUT** and mail the card—the postage is on us.
- **SUBSCRIBE** to *inCider* by checking off the \triangleright where indicated. We'll bill you \$27.97 for 12 issues of *inCider* delivered to you monthly. **That's 40% off the cover price.** Look for your subscription in 6 to 8 weeks.

NO OBLIGATION. Literature on products and services will be sent to you directly from advertisers, free of charge.

READER SERVICE INDEX

| Reader Service | Page |
|----------------|---------------------------------------|
| 286 | Abacadata.....66 |
| 103 | Alltech Elec. Co. Inc.....101 |
| 33 | Alpha One Computers Unlimited.....106 |
| * | Applied Engineering.....13, 23, |
| | 27, 39, 60, 61, 74, 75, 77, 93, 95 |
| 54 | Applied Ingenuity.....29 |
| 179 | Beagle Bros.....2, 3 |
| 295 | Berkeley Softworks.....64, 65 |
| 87 | Bible Systems Research.....106 |
| 225 | Black Sun.....103 |
| 66 | Borg Industries.....106 |
| 287 | Cambridge Marketing.....98 |
| 116 | Canadian Computer Outlet.....106 |
| 8 | CDA Computer Sales.....73 |
| 62 | Central Point Software.....31 |
| 94 | Choice Computer Products.....105 |
| 124 | CompuServe.....57 |
| 205 | Computer Direct, Inc.....86, 87 |
| 5 | Computer Emporium.....104 |
| 288 | Computer Friends.....91 |
| 142 | Computers Plus Company.....105 |
| 80 | Dandam Software.....103 |
| 268 | Data East Inc.....37 |
| 57 | Data Recall.....105 |

| Reader Service | Page | Reader Service | Page |
|----------------|--|----------------|--|
| 134 | Dayton Computer Co.....103 | * | Public Domain Exchange.....83 |
| 108 | Diversified Software.....72 | 136 | Quality Computers.....16, 17 |
| 73 | DMA Technologies.....104 | 7 | Ramco Computer Supplies.....105 |
| 85 | Fas-Track Computer Prod.....99 | 83 | Ready Access Memory.....101 |
| 132 | First Class Peripherals.....6 | 90 | Roger Coats.....51 |
| 61 | GE Ridge Services.....104 | 185 | S.A. AuTeur Company.....106 |
| * | Golem Computers.....10, 11 | 29 | Shreve Systems.....104 |
| 27 | Gosselin Computer Services.....102 | 143 | Silicon Express.....59 |
| 23 | International Software Library.....107 | 292 | Softdisk.....1 |
| 163 | Interplay.....5 | 96 | Softronics.....106 |
| 43 | Island Computer Services.....104 | 127 | SoftSpoken.....103 |
| 70 | Island Computer Supply.....106 | 270 | Software Disc. of America.....71 |
| 199 | Jameco Electronics.....94 | 18 | Sports Software Assoc.....105 |
| * | Kensington Microwave.....CV4 | * | Street Electronics.....CV3 |
| 131 | Kinson Products.....15 | 156 | subLOGIC Corp.....50 |
| 175 | Laser Computer Inc.....CV2 | 110 | Taito Software Inc.....9 |
| 248 | Memory Plus Distributors.....55 | 78 | TCX Ltd.....106 |
| 4 | Merritt Computer Products.....103 | 10 | The Experts.....102 |
| 55 | NAUG.....104 | 68 | Thunderware.....79 |
| 173 | New Science Prospects.....105 | 297 | USA Micro.....14 |
| 98 | Nexo Distribution.....103 | 214 | Valuesoft.....82 |
| 271 | Nikrom.....72 | 250 | Virgin Mastertronic International Inc.....97 |
| 89 | North Forty Enterprises.....104 | 283 | Virginia Reel Company.....103 |
| 37 | Ohio Kache Systems.....25 | 260 | Zimco Int.....4 |
| 59 | Perfect Solutions Software.....102 | | |
| 77 | PIE.....103 | | |
| * | Preferred Computing.....63 | | |
| 215 | Price Busters.....60 | | |
| 105 | Price Busters.....67 | | |
| 128 | Programs Plus.....32, 35 | | |

This index is provided as an additional service. The publisher does not assume liability for errors or omissions.



ram.
ready access memory

GS Memory Hungry?
Appleworks GS or others lock-up or crash?
Use new larger one megabyte memory cards
cooler - cheaper - faster

AE GS Ram Plus - 1 to 6 meg capable.
Plus Ram GS/8 - 1 to 8 meg on one board.

Both cards include:
Five year guarantee
Diagnostic utilities
Appleworks expander

AE GS Ram Plus - with 1 megabyte - \$349.00
Plus Ram GS/8 - with 1 megabyte - \$299.00
Extra Banks One Meg Chips \$199.00

No limits - Dealer's invited.
Other products available at excellent prices.

Visa/MC/Checks - S/H extra.

RAM
907 River Road Suite 289
Eugene, OR 97404
503/461. 2046

ALLTECH ELECTRONICS, Co., Inc.
1300 E. EDINGER, STE D, SANTA ANA, CA 92705
208 W. LOMITA BLVD., SUITE #1, LOMITA, CA 90717
TEL: (714) 543-5011 FAX (714) 543-0553

| | |
|--|--|
| Full Height Drives for Apple II, II+, Iie\$65.00 Iic\$75.00 | Apple II, Iie, Power Supply Refurbished\$35.00 w/Exchange\$29.00 |
| MANUALS FOR APPLE Apple Works w/Diskette\$35.00 Apple Writer II Users w/Diskette..\$29.00 ProDos Users w/Diskette\$15.00 Super Pilot Language\$10.00 Super Pilot Editors\$10.00 Super Pilot Log Guide\$5.00 Pascal Profile Managers\$10.00 MacProject\$10.00 MacDraft\$10.00 MacDaisy Wheel Connection (Diskette & Cable)\$20.00 | BOARDS FOR APPLE IIGS 1MB Ram Board ØK\$49.00 Iie 1MB Ram Board ØK\$69.00 Iic 1MB Ram Board ØK\$79.00 II+ 1MB Ram Board ØK\$89.00 80 Col Card II, II+\$69.00 64K/80 Col Iie\$35.00 128K/80 Col Iie\$45.00 Z80 Card\$39.00 16K Ram Expander II+\$49.00 Super Serial Card\$89.00 Graphic Card for printer\$35.00 Graphic Card w/2K BFR\$45.00 |
| CABLES FOR APPLE Laser 128 Parallel Cable\$15.00 Iic Serial Printer w/Modem\$9.95 Image Writer II Cable\$9.00 MacPlus Serial Cable\$5.00 Mac Serial Printer/Modem\$9.00 Centronics M/M, M/F, F/F\$9.00 Iic to Image Writer\$9.00 AB Switch Box\$19.00 ABCD Switch Box\$29.00 | COMREX DELUXE JOYSITCK For Apple II, II+, Iie\$12.95 For Apple Iic\$14.95 |
| MEMORY CHIPS FOR APPLE 41256-15 or 12 Ram Chip (each) ...\$Call 4164-15 Ram Chip (each)\$1.50 4164-20 Ram Chip (each)\$9.99 | |
| Apple Iic Carrying Case Quantity Limited\$29.00 | |

Above prices are subject to change without notice. Refunds subject to 20% restocking fee. Our liability is limited to purchase price. Above prices are cash and carry. Credit cards, add 3%. Shipping, COD, and insurance charges extra.

Figure 1. Filter attenuates "tuned" frequencies.

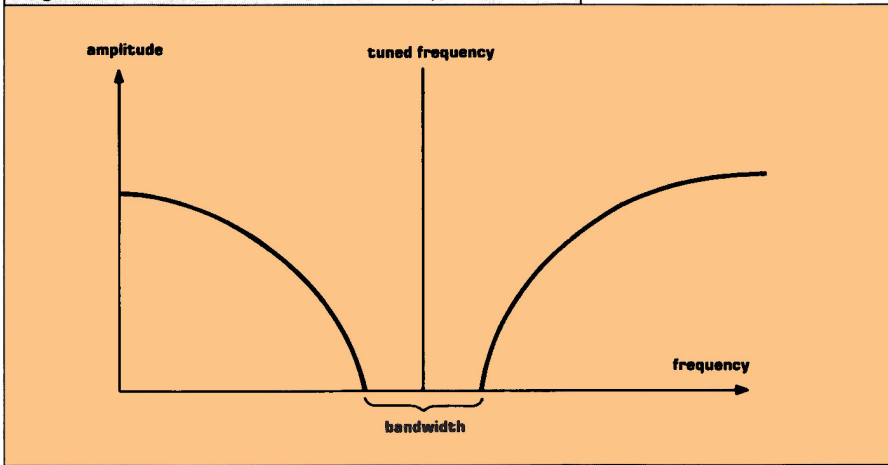
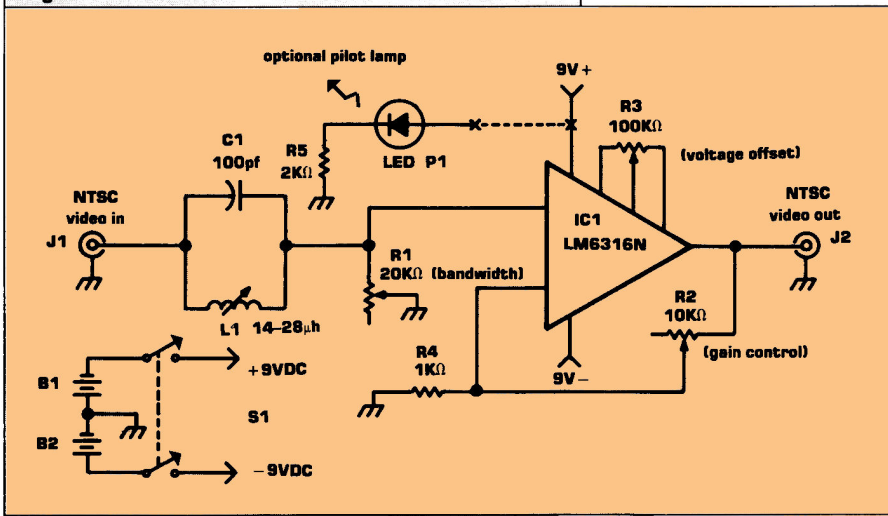

Figure 2. Schematic for 3.58-Mhz notch filter.



The connectors are simple, so I'll leave the details to you.

Once you construct the circuit, you'll have to make some adjustments. With the filter disconnected and the power off, center all three trimmer pots. Next, using a plastic allen wrench or a thin, wooden stick with one end whittled square, center the slug inside the coil, L1. (Never use anything metal, such as a small screwdriver, to adjust the coil.) Now you're ready to connect the filter and power up.

The notch filter goes in between your GS' video-out port and the video input on your television or VCR. Run a coaxial cable from your GS' composite-video output to the filter's input; run another coax from the filter's output to the video input of your VCR, or your television's monitor input (not the antenna).

Switch on your television, GS, and filter, and

an image should appear on screen. Adjust the coil carefully for the best picture. Next, adjust R1 slightly, and see whether the picture improves. (R1 controls the bandwidth of the notch.) By finding the proper settings for the coil and R1, you should notice a dramatic improvement in picture quality. If the picture seems a little dim, try adjusting R3, which controls the amplifier's gain for a slightly stronger video signal. □

Write to Bruce Jordan at 1620 Dix Street, San Mateo, CA 94401.

GOT A HINT OF YOUR OWN? INCIDER WOULD LIKE TO SEE IT. IF WE CAN USE IT IN HINTS & TECHNIQUES, WE'LL BUY IT FROM YOU. SEND YOUR TIP TO INCIDER, ELM STREET, PETERBOROUGH, NH 03458.

LASER 190A.....\$195 ImageWriter Compatible Printer

Amber monitor.....99
Mouse for Laser & Apple IIc.....55
External 5.25" Drive for Laser & Apple...95
External 3.5", 800K Drive.....179
RGB Color Monitor + Green + Tilt & Swivel.....259

LASER 128EX....\$415

LASER 128...\$339 ea. for purchase of 3 with school P/O

We use what we sell, so when you deal with us, it's on a personal basis with a computer user. Try us out and see the difference!

RAM CHIPS 256K-120 nanosec \$9.75 ea.

Taxcalc-88....\$14.95- \$2 s&h
calculates the 1040 + 11 common IRS forms & schedules

AppleWorks.....\$185

Chinook Hard Drive....\$495

20 meg for Apple e & gs. Laser 128EX & Apple IIc version...\$595

School Pricing (3+). Add 3% (\$5 min) for shipping.

PERFECT SOLUTIONS SOFTWARE

3701 Savoy Lane, Suite 106-D, West Palm Beach, FL 33417

(407) 471-7786 8 AM-8 PM Sun-Fri

Circle 59 on Reader Service Card.

COLORED PAPER

School Approved

1-800-322-2580
In Michigan (313) 227-8401

VISA, MC, C.O.D.
Minimum Order \$25.00
Shipping & Handling \$3.50

A. - BRITETONES - 9-1/2x11 - CLEAN EDGE
Red • Yellow • Green • Hot Pink • Blue • Gold
PRISM PACK 25 of each color.....\$12.95
Single Color 50 Pack.....\$ 3.95

B. - SOFTONES - 9-1/2x11 - CLEAN EDGE
Pink • Ivory • Green • Yellow • Blue • Lilac
PRISM PACK 25 of each color.....\$10.95
Single Color 50 Pack.....\$ 3.25

C. - GLOTONES - 9-1/2x11 - CLEAN EDGE
Glo-Pink • Glo-Melon • Glo-Lemon
PRISM PACK 25 of each color.....\$ 6.95
Single Color 50 Pack.....\$ 4.95

D. - CERTIFICATE PAPER - 9-1/2x11 - CLEAN EDGE
PARCHMENT PACK 25 with Gold Metallic Seals.....\$ 4.95

Write for Our **FREE** Brochure Featuring
COLORED PAPER
Continuous Labels, File & Post Cards, Disks,
Classic Laid Stationery and Much More!

• The Experts • PO BOX 928 • Brighton, MI 48116

Circle 10 on Reader Service Card.

ATTENTION ROLE PLAYERS

Make these games easier using the following:

CHARACTER EDITORS—\$19.95 each
Might and Magic, Deathlord, Ultima 3, Ultima 4, Ultima 5, Bard's Tale 1, Bard's Tale 2, Bard's Tale 3, Wasteland, Wizardry (1-3), Wizardry 4, Wizardry 5, Might and Magic 2, The Magic Candle, and Pool of Radiance.

HINT BOOKS—\$9.95 each
Might and Magic, Wizardry 1, Wizardry 2, Wizardry 3, Wizardry 4, Wizardry 5, Legacy of the Ancients.

OTHER MIGHT AND MAGIC PRODUCTS
Monster Editor (Change the monsters)—\$12.95
Construction Set (Make new scenarios)—\$24.95
Halbardon (New scenario for M&M I)—\$19.95

Commodore and IBM versions also available.
Add \$3.00 for shipping and handling.

GOSSELIN COMPUTER CONSULTANTS

P.O. Box 1083
Brighton, MI 48116
(313) 229-2453



Circle 27 on Reader Service Card.

NEW LOWER PRICES

CARDS: LOWEST PRICES

| | |
|---|---------|
| Extended 80 Column w/64K (Ile) | \$33.95 |
| Disk controller (II + e) | 29.95 |
| 16K RAM \$29.95 128K RAM(II, +) | 99.95 |
| Graphic printer card w/cable | 33.95 |
| Ile/ + Cooling fan w/surge protect. | 29.95 |
| Music card w/2 speakers (II, +) | 29.95 |
| Ile Numeric keypad | 29.95 |
| Z-80 CP/M Card | 29.95 |
| ALS Z-80B w/64K/CP/M 3.0 | 99.95 |
| Super serial card | 49.95 |
| Hi-speed eeprom burner | 49.95 |
| Ile Keyboard replacement | 59.95 |
| IGS 1 Meg/Ram card | CALL |
| Disk Notcher | 4.95 |

1 year warranty. Add 5% shipping (minimum \$5); APO/Canada add \$2 extra; VISA/MC add 4% Minnesota residents add 6% sales tax.

P.I.E.

P.O. Box 13509, MINNEAPOLIS, MN 55414
612-545-1715 (11 am - 7 pm Mon-Fri)

SCHOOL P.O. & DEALERS WELCOME

Circle 77 on Reader Service Card.

NEW! A REAL TREASURE HUNT ADVENTURE

Problems seem insurmountable but nothing quite prepares you for the Great Temple.



intro. special
\$34.95

TENPINS DUCKPINS ANCHORMAN

REALISTIC BOWLING
\$39.95

"the next best thing to a trip to the local bowling alley." Neil Shapiro, nibble
"really is good fun." Life Low, inCider
Satisfaction Guaranteed



Virginia REAL

VISA/MC CALL (804) 567-4952
Check/M.O. MAIL To: Virginia Real Software, Inc.
Box 8545, Norfolk, VA 23503

Circle 283 on Reader Service Card.

AppleWorks ↔ IBM

You can easily exchange AppleWorks data files with the most popular IBM PC programs:

AppleWorks IBM PC

Word Proc. ↔ WordPerfect
Keeps underline, bold, center, margins, etc!

Spreadsheet ↔ Lotus 123
Keeps formulas, cell formats, col. widths, etc!

Data Base ↔ dBase III +
Keeps category/field names, etc!

It's easy! Just select file names to send from the menu; CROSS-WORKS does the rest! Includes universal 19,200 baud cable (Ile, Iic, & IIGs to PC, XT, AT, PS/2 & compatibles). Supports modem transfers too.

5¼ & 3½ inch disks.
Only \$79.95!

Call (919) 878-7725
for free information.

SoftSpoken

P.O. Box 97623
Raleigh, NC 27624

Circle 127 on Reader Service Card.

APPLE COMPATIBLES! LOWEST PRICES ANYWHERE CALL/WRITE FOR OUR NEW COLOR CATALOG

ONE MEGABYTE RAM BOARDS? WE'VE GOT THEM!

| | |
|--|--------------|
| Super Expander GS for IIGs ØK | \$39 |
| Super Expander E for Ile ØK w/Software | \$59 |
| Super Expander C for IIC ØK w/Software | \$69 |
| Super Expander + for II+ ØK w/Software | \$79 |
| * Appleworks Expansion, RAM-disk emulation, & more Above with 256K, 512K, or 1 MEG | CALL |
| 64K/80 Column Board for Ile | \$34 |
| 80 Column Board, Videx Compatible, for II+ | \$48 |
| Z80 CP/M Board, Microsoft Compatible, II+/e/g/s | \$34 |
| Graphic Parallel Board w/6ft Cable, for II+/e/g/s | \$46 |
| Cooling Fan (Kens. style w/surge protect) II+/e | \$26 |
| GS Super Cooler, No audio line interference, IIGs | \$24 |
| Joystick, Like Mach III w/stick button II+/e/c/g/s | \$24 |
| Disk Drive H/H, Specify II+, Ile, IIC, or IIGs | \$119 |
| Disk Controller Board for II+/Ile/IIGs | \$34 |
| Switchbox (specify par or ser) A/B/C/D \$39 A/B \$29 | |
| Numeric Keypad II for IIC \$39 | for Ile \$35 |
| Nettalk II w/15ft CBL (Localtalk Comp.) | \$55 |
| 16K Ram Board II/II+ | \$34 |
| 128K Ram Board II/II+ | \$64 |
| Super Serial Board II+/e/g/s | \$48 |
| Power Supply 5 Amp II+/Ile | \$49 |
| TV Modulator II+/Ile | \$15 |

DEALERS INQUIRES INVITED!

NEXO DISTRIBUTION

914 E 8th St., Suite 109, National City, CA 92050
(619) 474-3328 10 am - 6 pm Mon-Fri



Circle 98 on Reader Service Card.

SOUND SYSTEM™ 2 New 2-Way Stereo Amplified Speaker System for your Apple IIGs, Ile, IIC, II+ and Macintosh

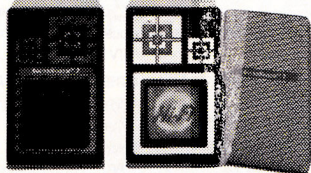

More versatile than the Bose Roommates, the no slot operation of the SS2 will make all speech, music, games, and other sound programs come to life on any Apple.
Prepare to be blown away by this thunderous amplified speaker system, because the SS2 has over 3 times the power of any Apple amplifier Board. You won't believe your ears!
The 2 way super heterodyne speakers, coupled with state of the art noise filtering, provides a high quality stereo sound, crystal clear to any listener.
Unlock the full sound potential of your Apple! You never knew your computer could sound so good! ONLY \$129 PR (Call Write for our complete color catalog) B&S & Roommates are trademarks of Bose Corp.

TWO YEAR WARRANTY ON ALL PRODUCTS
UNIV. & SCHOOL P.O.'s WELCOME!
add \$3 Shipping/COD Okay/VISA/MC no extra fee.

RIBBONS

1-800-331-6841

1-513-252-1247
FAX 513-252-4429

Over 350 types
Volume Discounts Available

★ ★ Satisfaction Guaranteed ★ ★

| | BLACK COLORS | |
|-------------------|--------------|------|
| APPLE IMAGEWRITER | 2.60 | 3.60 |
| APPLE 4-COLOR | — | 8.95 |
| DIABLO HT II M/S | 2.25 | — |
| EPSON LX-80/90 | 2.10 | 3.50 |
| EPSON MX-FX 80 | 2.50 | 3.50 |
| EPSON MX-FX 100 | 3.50 | 4.50 |
| IBM PROPRINTER | 3.50 | 5.95 |
| NEC P1, 2, 6 | 4.50 | — |
| OKIDATA 182-192 | 3.50 | 4.50 |
| PANASONIC 1080 | 3.50 | 4.50 |
| PANASONIC 1124 | 5.75 | — |
| STAR NX-1000 | 3.25 | 5.50 |

DAYTON COMPUTER SUPPLY

a division of Den-Sys Corp.

1220 Wayne Avenue, Dayton, Ohio 45410

EST. 1979

TERMS: C.O.D. MC, VISA, DISCOVER

Circle 134 on Reader Service Card.

CANADIAN MA. LASER SPECIAL \$619

DANDAM SOFTWARE

"We specialize in Apple II Software & Peripherals"

LASER 128EX/2 \$619 2 Yr. CDN. WARRANTY

LASER 3.5" DRIVE \$279 with U.D.C. \$389.00

LASER 5.25" DRIVES \$159 /Ile or /Ic

AUTHORIZED APPLIED ENGINEERING DEALER
LARGE SELECTION OF APPLE II & IBM SOFTWARE
TIMEOUT SERIES - SPRINGBOARD - TIMEWORKS - EPYX

CHINOOK HARD DRIVES FROM \$849.00
EDUCATIONAL DISCOUNTS

MODEMS - CMS HARD DRIVES - ROCKET CHIP
MANY NEW PRODUCTS ARRIVING EVERY DAY

WE ARE 100% CANADIAN OWNED & OPERATED
member of the BETTER BUSINESS BUREAU OF WINDSOR

TOLL FREE Call for free Catalogue CANADA WIDE
\$ CANADIAN FUNDS \$

P.O. Box 3374 Tecumseh, Ontario, N8N 3C4 • Canada
(519) 974-3011 ORDER DESK 1-800-265-9576

Circle 80 on Reader Service Card.

RENT SOFTWARE

OVER 2500 APPLE TITLES!

- Nation's largest library
- Name Brand Software
- 21 Day rental period
- Rent applied to purchase
- 10 to 20% of list price
- \$20.00 Membership fee
- Money-Back Guarantee!!

Black Sun, Inc.
1988 Chestnut Street
Emmaus, PA 18049
1-800-BLACKSUN



Circle 225 on Reader Service Card.

NEW!



SafeSkin™

KEYBOARD PROTECTOR

Finally! A Keyboard Protector That:

- PROTECTS CONTINUOUSLY - 24 HOURS A DAY - Against computer downtime due to liquid spills, dust, ashes, staples, paper clips and other environmental hazards.
 - REMAINS IN PLACE during the operation of your keyboard. Safeskin is precision molded to fit each key - like a "second skin."
 - EXCELLENT FEEL - The unique design eliminates any interference between adjacent keys, allowing smooth natural operation of your keyboard.
- Available for Apple II, II+, Ile, IIC, GS, MAC, MAC+ and most other popular PC's. List \$29.95, check, MO, Visa, MC. Specify computer type. Dealer inquiries invited. Free brochure available.

Merritt Computer Products, Inc.

4561 S. Westmoreland / Dallas, Texas 75237 / 214/339-0753

Circle 4 on Reader Service Card.



Trying to find the best source of AppleWorks information?

Read the AppleWorks Forum, the largest and most comprehensive monthly AppleWorks newsletter. Only \$27 a year.

National AppleWorks Users Group
Box 87453
Canton, Michigan 48187
(313) 454-1115

Circle 55 on Reader Service Card.

New & Used Apple Stuff!!

We Buy, Sell & Horsetrade Popular Computers!!

Specials of the Month!!
 IIGs CPU.....\$825.
 II+ Extended Keyboard \$12.

Need Parts-CALL!!!!
318-635-1121

Shreve Systems

2421 Malcolm St.
Shreveport, La. 71108
Fax 318-865-2006 C.O.D. & visa/mc o.k.

Circle 29 on Reader Service Card.

TAX PLANNING MADE SIMPLE WITH TAXMASTER



IS THIS YOU? IF YOU HAVE APPLEWORKS AND 128K, IT DOESN'T HAVE TO BE LIKE THIS!
(Mac & IBM versions too!)

TAXMASTER users don't worry about their tax situation. You can stop worrying too. Order today, or call us for more information on how you can solve your tax preparation and planning problems. Only \$50.00. Upgrade to 1989 Prep next year.

 **(800) 826-7146** 

ISLAND COMPUTER SERVICES
 3501 E. YACHT DRIVE
 LONG BEACH, N.C. 28465
 (919) 278-9483

Ask about the Home Money Pack too!

Circle 43 on Reader Service Card.

QUALITY AT A DISCOUNT

| | | | |
|---|---|--|---|
| HARD DISK DRIVES: | RamCharger \$135 RamKeeper \$147 Slot Mover 32 | Laser 128 \$365 128EX \$445 EX2 Due 5/89... Call | Master Tracks Pro IIe \$239 NEW GS Pro.....308 |
| Warp SCSI/Scuzzy, Hi Speed, Auto Parking, Multi Language, Stackable, Includes GS/OS & ProSet: | Ram Express: 256K 199 512K \$299 1Mb.....499 | 3.5" Drive + UDC Controller \$255 3.5" Dr.....190 | Master Tracks \$195 Master Tracks Jr.....120 |
| 35ms: 26Mb \$720 38Mb 790 57Mb.....875 | Ramfactor OK 149 256K 210 512K.....299 | Mouse \$49 Ext Slot Expan Bx \$56 | MultiScribe 3.0 \$65 GS \$65 Music Tutor.....172 |
| 19ms: 84Mb \$1399 25ms: 104Mb.....1365 | 1Mb \$459 2Mb 859 3Mb 1109 4Mb.....1359 | TV Interf.....29 | Music Writer #1 \$95 #2 \$225 #3.....445 |
| CMS Stack SCSI: 65ms 20Mb.....665 | RamWorks III OK 111 64K 149 256K.....179 | OTHER HARDWARE AND SOFTWARE | PaintWorks Gold \$66 Printtech \$39 |
| 40ms 43Mb \$835 60Mb.....935 | 512K 275 1Mb 469 2Mb 799 3Mb.....1049 | Magnavox Amber or green | ProGrappler.....89 |
| Chinook 20Mb 560 40Mb \$725 IIc 21Mb.....670 | PC Transporter 768K \$525 Math Co-Processor.....179 | Composite Monitor.....105 | Passport: MIDI w/Drum Sync \$115 |
| APPLIED ENGINEERING: | Keyboard 110 Installation Kit GS \$39 IIe/+.....31 | Color Composite/RGB \$269 | Tape + Drum.....179 |
| Transwarp GS \$292 Transwarp 2e/2+.....149 | Single Drive 199 Dual \$299 Extra Dr.....110 | RGB GS Compatible.....375 | PolyWriter \$225 Utilities \$75 MIDI 8+.....120 |
| Sonic Blaster \$99 Audio Animator.....195 | DataLink Modem 1200 Bd \$135 2400 Bd.....179 | Panasonic DM Printers: 1124 \$380 1180.....199 | Rocket Chip \$170 Quicken \$34 Top Draw.....58 |
| GS Ram OK \$112 256K \$175 512K 254 | Parallel Pro \$79 BufferPro 32K 85 Addl 32K.....15 | 1191 \$265 1092 \$399 1592 \$475 1595.....215 | Supersonic \$49 Digitizer \$49 GS Stereo.....35 |
| 1Mb 420 1.25Mb \$499 1.5Mb 580 2.5Mb | Phasor \$129 ViewMaster \$127 Hvy Duty Power.....63 | AppleWorks 2.1 \$195 GS.....510 | ThunderScan \$173 Turbo Mouse ADB.....126 |
| 1029 3.5Mb.....1299 | Z Ram Ultra 1 OK \$110 256K 179 512K.....269 | Bose RoomMate Speakers \$229 C/Mac/GS.....99 | Tomahawk \$30 Word Attack Plus \$29 WorkBench..99 |
| GS Ram Plus: 1Mb \$389 2Mb \$649 3Mb.....899 | Z Ram Ultra 2 OK 169 256K 229 512K.....319 | Dazzle Draw 39 Deluxe Paint II \$65 816 Paint.....46 | |
| 4Mb 1149 5Mb 1399 6Mb.....1649 | 768K \$410 1Mb 479 Z Ram Ultra 3 OK.....232 | Digitizer Pro \$152 FantaVision \$39 Clip Art.....21 | |
| GS Ram Ultra: OK 135 256K 191 512K.....284 | 256K 279 512K 379 768K 469 1Mb.....539 | FingerPrint GSI #2 \$95 Plus \$99 G+.....59 | |
| 1Mb 495 1.5Mb 720 2Mb 914 3Mb.....1026 | Z80c \$129 Z80 Plus.....119 | GS System Saver \$73 2e/2+ 69 Geo Publish.....75 | |
| | Ram Chips 128K for PC Transporter.....119 | ImageWriter II Buffer 64K \$47 128K.....77 | |
| | 256K 120ns \$10 150ns \$13 1Mb 100ns/120n .27 | Kurta Tablet IS/GS ADB \$299 IS/1.....376 | |

Free illustrated catalog. Pay by check: Free Shipping. Credit card & COD: Shipping added. We honor Master Chg, Visa, Discover Card, also accept with 4% surcharge: Amer. Exp, Diners & Carte Blanche. NY residents add sales tax. Federal, State and local government agencies, school and college orders accepted Net 30 Days, FOB shipping point.

NORTH FORTY ENTERPRISES LTD. P.O. Box 172B, E. Meadow NY 11554 Tel. (516) 679-8790 Fax (516) 783-4873 7 Days to 11 P.M.

Circle 89 on Reader Service Card.

REMOVABLE HARD DISK DATA STORAGE

DMA cartridge hard disk drives provide random access mass storage with unlimited capacity, total data removability, and complete data security. Reliable winchester technology. Operate on both PC and Apple IIGs systems. 10MB formatted storage per cartridge. Higher capacities available. Extended warranty.

DMA 360, Controller Enclosure/PS, Manual \$560.00

MEGABOARD HARD DRIVE CONTROLLER

The only ST506 winchester controller for the Apple II and IIGs. Install ProDOS, GS/OS, DOS 3.3, CPM, and UCSD Pascal. Standard ST506 interface works with low cost PC hard drives up to 64MB. Adjustable partitions for each operating system. Operating systems are bootable. Installs in IIe slots 1-7 or IIGs slot 7.

MEGABOARD, Software util., Cable, Manual \$195.00
 Payment by VISA/MASTERCARD, or COD. Add \$5.00 shipping. CA residents add 6% sales tax.

DMA TECHNOLOGIES, INC.
 601 Pine Ave., Goleta, CA 93117
 Call 805-964-0733 for information
 Fax: 805-964-0734

Circle 73 on Reader Service Card.

LASER 128EX ONLY \$415!

| | | | |
|-------------------------|------|------------------------|-------|
| IIe,IIc SOFTWARE | Call | IIGs SOFTWARE | Call |
| AJF | \$47 | Aarrgh! | \$24 |
| Bank St. Writer + | \$40 | Alien Mind | \$30 |
| Battles of Napoleon | \$30 | Bubble Ghost | \$21 |
| Defender of Crown | \$31 | Battlechess | Call |
| GeoPublish | \$60 | King Arthur | Call |
| Might & Magic 1 or 2 | \$30 | Kings Quest 1, 2, 3, 4 | \$29 |
| Neuromancer | \$27 | Mancala | \$24 |
| Print Shop | \$28 | Paperboy | \$28 |
| Tetris | Call | Print Shop | \$35 |
| Time & Magik | Call | Shogun | Call |
| Ultima 4 or 5 | \$35 | Skate or Die | Call |
| Wings of Fury | \$21 | Strip Poker II | \$24 |
| HARDWARE | | Apicorn | |
| Laser 128EX/2 | Call | Super Serial Pro | \$49 |
| Laser Amber Monitor | \$90 | Anchor 2400E Modem | \$160 |
| Laser Mouse | \$49 | Zip Chip | Call |
| Laser Joystick | \$19 | | |

Computer Emporium 918/341-0840
 M-F 10-6 Sat. 11-4 RRS #129 Canary Lane
 Clarendon, OK 74017

We accept Cert. CK, M.O., and MC/VISA (+2 1/2%) Add shipping. OK add sales tax. Returns on defective only (15 days). Call for authorization number. Prices and terms subject to change.

Circle 5 on Reader Service Card.

WIN LOTTO MILLIONS\$!



NOW FOR APPLE! LOTTO PICKER PLUS, the original lottery selection software, allows you to store winning Lotto, Keno, & Pick 3/4 numbers & choose between three modes of probability analysis (hot, due, unbiased) in order to give you the winning edge! Guaranteed to work for all lotteries. Bonus numbers are easily handled and our full-featured database editor gives you access to your files. We give you the PICKS—not a bunch of jumbled statistics! \$34.95 for 5.25" disk. \$44.95 for 3.5". For all Apple II, Laser, MS-DOS, and Commodore 64/128. NY residents please add sales tax. NOT Copy-protected!

CREDIT CARD ORDERS:
 1-800-634-5463 ext. 293

GE RIDGE SERVICES
 170 Broadway, Suite 201-JC
 New York, NY 10038 Info 718-317-1961

Circle 61 on Reader Service Card.

**APPLE
Ile/c
APPLEWORKS
PRINTSHOP**



**IBM
PC/XT
LOTUS 123
d Base IV**

The Best of both Worlds in the **LASER Turbo XT**

///LASER TURBO XT \$795⁰⁰

Monochrome monitor, printer & game ports, clock, color card, MS-DOS & GW Basic **512K, 2-FDD**

///LASER DUO \$1195⁰⁰

w/128K Apple Ile RAM . . . and 2 5.25" IBM/Apple Drives
For Laser 20 meg Hard Drive . . . Add \$275⁰⁰ Reg \$295⁰⁰
For Intec RGB Color monitor . . . Add \$185⁰⁰ Reg \$200⁰⁰
For Laser RGB Color monitor . . . Add \$230⁰⁰ Reg \$250⁰⁰
For Laser 190 Printer & Cable. . . Add \$209⁰⁰ Reg \$229⁰⁰
For 640K IBM RAM upgrade . . . Add \$ 48⁰⁰ Reg \$ 64⁰⁰
For AppleWorks V2.1 Add \$175⁰⁰ Reg \$195⁰⁰
* Price when purchased with Turbo XT or Duo unit.

NEW SCIENCE PROSPECTS

Your full Laser® Computer Service Center
P.O. Box 430304 Houston, TX 77243
713-464-7071
School orders welcome

Circle 173 on Reader Service Card.

Choice Computer Products

PO BOX 8432, CEDAR RAPIDS, IA 52408
CUSTOMER SATISFACTION IS OUR #1 PRIORITY

AUTHORIZED AE APPLIED ENGINEERING™ DEALER

FACTORY INSTALLED / WARRANTED RAM

| | | | |
|-------------------------------|-------|-----------------------------|-------|
| PC TRANSPORTER | \$509 | SONIC BLASTER | \$ 97 |
| SINGLE TRANSDRIVE | 194 | AUDIO ANIMATOR | 179 |
| DUAL TRANSDRIVE | 292 | PHASOR | 127 |
| IIGS KIT | 37 | DATALINK 1200 | 134 |
| IIE KIT | 29 | DATALINK 2400 | 179 |
| RAMWORKS III 256K | 187 | SERIAL PRO | 104 |
| RAMFACTOR 256K | 224 | PARALLEL PRO | 74 |
| RAMCHARGER | 134 | COLORLINK | 97 |
| GS RAM 256K | 164 | VIEWMASTER 80 | 119 |
| GS-RAM ULTRA 256K | 167 | AE EXTENDED 80 | 74 |
| GS RAM + 1MEG | 449 | TIMEMASTER | 74 |
| RAMKEEPER | 142 | H.D. POWER SUPPLY | 59 |
| RAM EXPRESS 256K | 187 | AE DISK DRIVES | 112 |
| RAM EXPRESS D-CLOCK | 44 | POCKET ROCKET | 74 |
| TRANSWARP GS | 309 | TRANSWARP | 149 |

Call us for the lowest prices on all AE products

OTHER FINE PRODUCTS

| | | | |
|--|-------|---------------------------------------|-------|
| KENSINGTON SYSTEM SAVER IIGS | \$ 76 | KENSINGTON SYSTEM SAVER IIE | \$ 69 |
| CHINOOK 20MEG | 575 | SCSI INTERFACE | 125 |
| CHINOOK 30MEG | 650 | APPLEWORKS GS | 229 |
| CHINOOK 40MEG | 756 | | |

Call 319-396-2306 (9 am to 9 pm)

MasterCard, Visa, COD, P.O. & Checks Accepted. Prices subject to change

Circle 94 on Reader Service Card.

For IIGS & Ile

20Meg Hard Dr for IIGS, Ile \$649

60 Meg Hard Dr. for IIGS \$849

(Include Interface, cables and format instructions. above drives work with both 220V/110V, 60/50Hz.)

Computer Eyes for IIGS or Mac \$199

ThunderScan Ile,c,IIGS for Imagewriter \$189

Transwarp IIGS \$339

GSRAM PLUS with 0K expandable to 6Meg \$149

1 Meg Memory for GSRAM Plus \$199

256K 150ns set for IIGS/Ile card \$100

CONSERVER for IIGS by MDIdeas \$79

Turbo Mouse ADB Version 1 for IIGS \$59

Compatible 5.25" Drive for Ile \$139, Ile .. \$139

Deluxe Paint II 1024K IIGS . \$49

Pinpoint IIGS Starter Pak \$49

Music Studio IIGS \$49

MECC Calendar Crafter for 512K IIGS \$45

UniDos 3.3 Plus \$39

Universal File Conversion program Ile,c \$35

Pinpoint Desktop Accessory Ile, Ile \$39

Timeout SideSpread \$19

Timeout DeskTools I \$19

Reader Rabbit Ile, Ile \$19

Home Accountant ProDos \$19

Compuserve sign on kit \$19

MousePad for Mouse \$7.00

6 Ribbons for Scribe Printer \$36

6 Quality Ribbons for Imagewriter, Black \$48

6 Quality Ribbons for Imagwrtr multiclr \$72

CIRCLE READER SERVICE CARD FOR A CATALOG.

Note 1: Shipping \$4 per \$100 by surface in USA. Extra for other modes of shipment.

Note 2: Prices subject to change w/o notice.

Note 3: For Defective Merchandise, call in 10 days of receipt for Authorization. Refund/Replacement at our option.

SCHOOL ORDERS WELCOME.

COMPUTERS PLUS COMPANY

2303 N. 44th St. #2, Phoenix AZ 85008

PH: 602-955-1404

FAX: 602-840-3767

Prepared! 4/30/89



Circle 142 on Reader Service Card.

TAKE A SLICE OUT OF DATA ENTRY WITH THE NEW APPLE BAR CODE SCANNER

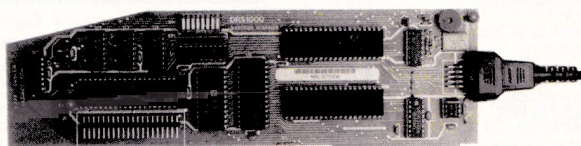

(pictured: special interface for Apple Ile)

The DRS 1000 Bar Code Scanner is designed as a keyboard wedge to assure years of compatibility to all Apple Ile software. Interfaces are also available to the IIGS and Macintoshes.

DATA // RECALL
BAR CODE SPECIALISTS

**CALL TOLL FREE
800-678-2633**

1711 Dell Ave., Campbell, CA 95008

Circle 57 on Reader Service Card.

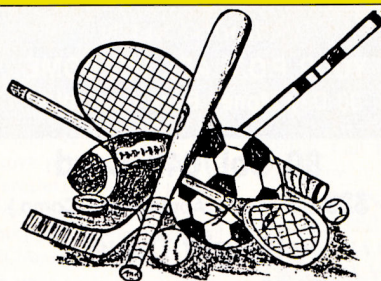

Sports Scheduler

- FEATURES:**
- Any league or category with 4 to 22 teams.
 - No limit on the no. of categories that can be scheduled.
 - Equal distribution of teams in playing slots.
 - Up to 231 games per schedule.
 - Dates calculated automatically.
 - Schedules list date, day, time, location, game number and opponents for each game.
 - Only minutes to schedule a league or category.

APPLE IIE (128K) IIC, IIGS 99.95
IBM PC & Compatibles + 3.00 S&H
\$102.95

Send check or money order to:
SPORTS SOFTWARE ASSOCIATES
75 Recreation Park Drive, Hingham, MA 02043
(617) 749-7880

Circle 18 on Reader Service Card.

COLOR RIBBONS & PAPER

Colors: Black, Red, Blue, Green, Brown, Purple, Yellow

| Ribbons: price each | Black | Color | T-Shirt Ribbons |
|-------------------------|--------|--------|--------------------|
| Apple Image, I & II | \$3.75 | \$4.50 | \$6.50 |
| Apple Image, II 4-Color | | \$7.50 | \$10.50 |
| Epson MX-80 | \$3.75 | \$4.50 | \$6.75 |
| Okidata 182/192 | \$6.50 | \$7.50 | \$6.00 |
| Panasonic KXP 1090 | \$6.75 | \$7.75 | |

T-Shirt (Heat Transfer Ribbons)

Colors: Black, Red, Blue, Green, Brown, Purple, Yellow

| | | |
|---------------------------------|----------------------------|--------------|
| Color Paper | 200 shts assorted | |
| Bright Pack: | 9 1/2 x 11 | \$11.95/pk |
| Pastel Pack: | 9 1/2 x 11 | \$11.95/pk |
| Color Certificate Paper: | 100 sheets | \$12.00/pk |
| Color Banner Paper: | 45 ft./roll | \$ 9.95/roll |
| Greeting Cards: | 50 cards & 40 envelopes/pk | \$11.95/pk |

Min. orders: \$25.00. Minimum S&H: \$3.50. Call for other ribbons and supplies. Price and spec. are subject to change w/o notice.

RAMCO COMPUTER SUPPLIES

PO Box 475, Manteno, IL 60950 U.S.A.
800-522-6922 or 815-468-8081

Circle 7 on Reader Service Card.

24 TERMINAL EMULATIONS

Softerm 2, an advanced communications package, includes 24 terminal emulations such as:

- DEC VT52, VT100, VT102
- IBM 3101-20 (block mode)
- HP 2622A • VIP7801, 7803
- DG D200 ... and many more.

Guaranteed Compatibility!!

Supports Script Files, Disk Capture, Softkeys, ProDos (floppy), DOS, CP/M, Pascal, & most vendor boards/modems.

Comes with Keyboard enhancer. For the Apple II, II+, IIe, & IIc.

\$195 MC-VISA-COD

SEIFTRONICS

1-800-225-8590

Call for information

(303) 593-9540

Telex 450236

Circle 96 on Reader Service Card.



CANADIAN COMPUTER OUTLET



LASER

128 EX
\$619



CHINOOK

CT-20C \$899
CT-20 \$829
CT-40 \$999

cordata

BRIDGE
APPLE & IBM
COMPATIBLE
\$1799

WE CARRY A COMPLETE LINE OF APPLIED ENGINEERING, ORANGE MICRO AND OTHER BRAND NAME PRODUCTS.

WRITE FOR YOUR **FREE CATALOGUE.**

Educational Discounts Available Dealer Inquires Invited Canadian Inquiries Only

Showroom: 134 Randall St. Oakville, ONTARIO L6J-IP4

Mail Order Warehouse: Box 7081, Oakville, ONT.L6J 6J5

Collect Calls For Orders Only! (416) 849-0737

Circle 116 on Reader Service Card.



AUTHORIZED LASER REPAIR CENTER

| | |
|---|-------------------|
| LASER 128 | \$369.00 |
| LASER 128EX | \$419.00 |
| LASER 190A PRINTER (IMAGEWRITER I) | \$209.00 |
| STAR NX-1000 PRINTER | \$189.00 |
| 5.25 EXTERNAL DRIVE II+ IIc IIe | \$ 99.95 |
| 5.25 DAISY CHAIN DRIVE IIgs | \$105.00 |
| 3.5 800K DISK DRIVE | \$185.00 with UDC |
| LASER/APPLE II COMPATIBLE MOUSE | \$ 54.95 |
| LASER/APPLE SELF-CENTER JOYSTICK | \$ 19.95 |
| HOME VIDEO PRODUCER by EPYX | \$ 31.95 |
| TIMEWORKS PUBLISH IT! | \$ 64.95 |
| CENTRAL POINT COPY II PLUS | \$ 22.95 |
| QUICKEN by INTUIT | \$ 29.95 |
| WORDPERFECT | \$ 95.95 |
| TETRIS by SPECTRUM HOLOBYTE | \$ 24.95 |
| MATH BLASTER PLUS by DAVIDSON | \$ 29.95 |
| CHUCK YEAGER'S APT | \$ 25.95 |
| CALIFORNIA GAMES by EPYX | \$ 24.95 |
| F-15 STRIKE EAGLE by MICROPROSE | \$ 22.95 |
| SILENT SERVICE GS by MICROPROSE | \$ 24.95 |
| JEOPARDY, JEOPARDY 11, FAMILY FEUD each | \$ 9.95 |
| WHEEL OF FORTUNE, CARD SHARKS each | \$ 9.95 |
| SONY 3.5 DS/DD DISKETTES, 10 PACK | \$ 19.95 |
| OAK FINISH DISK HOLDER HOLDS 50 3.5 | \$ 24.95 |

*****SEND FOR FREE CATALOG*****

ALPHA-ONE COMPUTERS Ltd.

1671 East 16th St., Suite 146 Dept. IC589, Brooklyn, NY 11229

(718) 692-4120, S/H \$4.00 USA, \$6.00 CANADA
SCHOOL AND COLLEGE P.O. ACCEPTED

Circle 33 on Reader Service Card.

FRENCH

GERMAN

EuroWorks™

ITALIAN

SPANISH

Type accented French, German, Italian, or Spanish quickly and simply with the **Classic AppleWorks®** word processor. Then, from inside AppleWorks, **EuroWorks** prints your foreign text on an ImageWriter® I, ImageWriter II, or compatible.

No goofy key equivalents: type "e" (not "é") to print é. No taboo keys either: foreign files may include every character on your American keyboard plus 13 French, 7 German, 10 Italian, or 10 Spanish. **EuroWorks** gives you 8 new characters for English too!

EuroWorks requires **Classic AppleWorks v2.0** USA or later and an Apple DMP, ImageWriter I, ImageWriter II, or Scribe; and MT85 or MT86; or a Seikosha SP-1000AP printer.

→ \$20 for ONE foreign language ←
\$30 for all FOUR

POSTPAID TO USA, Canada, Mexico; others add \$3.00
Apple®, AppleWorks®, ImageWriter® by Apple Computer, Inc.

Check, Money Order, Net-30 School P.O. Visa, or MC

The S.A. AuTeur Co: A66
P.O. Box 7459 Beaverton, OR 97007
(503) 645-2306

Circle 185 on Reader Service Card.

BIBLE RESEARCH SYSTEMS

Thousands of customers use our software and Bible text for KJV or NIV. Create your own concordances by searching for word and phrase combinations. Immediate display or print of any portion of the Bible. Also available: a Greek transliterator and topical concordances. For ProDos, Macintosh & MS-DOS.

Bible Research Systems

2013 Wells Branch Pkwy. #304

Austin, Texas 78728

(512) 251-7541 (Tech Support)

(800) 423-1228

Circle 87 on Reader Service Card.

FACTORY FRESH RIBBONS

| Ribbon | Black | Color |
|--------------------------------------|---------|---------|
| Apple Imagewriter I, II | \$ 2.50 | \$ 3.00 |
| Imagewriter II 4 color | | \$ 7.95 |
| Imagewriter II 4 color Heat transfer | \$12.95 | |
| Imagewriter LQ | \$12.50 | \$15.95 |
| Epson LX80/90 | \$3.35 | \$ 4.25 |
| Epson MX/FX/RX80 | \$2.90 | \$ 3.50 |
| Epson MX/FX/RX100 | \$3.80 | \$ 4.00 |
| Okidata 182/192 (Seamless Loop) | \$5.50 | |
| Panasonic 1080/90 (Seamless Loop) | \$5.50 | |
| Star NX1000 | \$4.50 | \$ 5.50 |

Hundreds more, call or write for prices. Colors (BLUE, RED, GREEN, PURPLE.) -PREMIUM IS ALL WE SELL!

Shipping/Handling \$3 per order (over \$50 we pay S/H). Check, Money Order, C.O.D., School purchase orders accepted. New York residents please add sales tax.

-MONEY BACK GUARANTEE
ISLAND COMPUTER SUPPLY
Box 3495, Farmingdale, New York 11735
(516) 798-6500

Circle 70 on Reader Service Card.

FOR CRISP, BLACK PROFESSIONAL PRINT
CHOOSE FROM 3 MODELS STARTING AT \$39.50

RE-INK FABRIC RIBBONS!

CALL TOLL FREE 800-553-2404
In Iowa 319-987-2976

B BORG INDUSTRIES
JANESVILLE, IOWA 50647

Circle 66 on Reader Service Card.

Schools! NET 30

YOUR P.O.'S ARE WELCOME
30 Day Money Back Guarantee

80 Col./64K Card
\$29.95 (100% AppleWorks Comp.)

1/2 Height Drive
\$77.00 (100% Apple Comp.)

| | |
|---------------------------------------|---------|
| Graphic Parallel Printer Card | |
| W/Cable | \$39.00 |
| Super Serial Card | \$48.00 |
| (Orig. Apple Super serial card comp.) | |
| Disk 2 Controller Card | \$29.00 |
| 16K RAM Card | \$30.00 |
| Z-80 (Cpm Card) | \$19.95 |

One year warranty on all products. Prices subject to change w/o notice. Add \$3.00 min. per \$100.00 for shipping. (Cash or bank check. Net 30 to univ. & schools.)

41 N. Mall

Plainview, NY 11803

(516) 249-1200



Circle 78 on Reader Service Card.

FREE APPLE SHAREWARE

Get 5 disks monthly with 10+ latest programs plus catalog-FREE! Pay only \$5.00 shipping/handling. Join today for only \$9.95 annual membership fee and get 5 bonus disks full of software.

VISA/MC/AMEX ONLY

Software of the Month Club
511-104 Encinitas Blvd.,
Encinitas CA. 92024
Toll free 800 669-2669

Circle 23 on Reader Service Card.

Public Domain

PUBLIC DOMAIN & SHAREWARE

Big 48 page catalog with descriptions of many programs Over 40 programs on some disks. Program disks cost as low as \$1.99 each. Thousands of programs available. Our catalog gives you descriptions of many programs, not just a program name. Our seventh year. No membership fee to pay. Software programs in all fields, Education & School, Games, Art & Graphics, Astronomy, Business & Finance, Chemistry & Biology, Electronics, Ham Radio, Math & Statistics, Music & Sound, Appleworks™ templates, plus much more. Something for everyone no matter what your age or occupation. Send only \$2 for big 48 page catalog sent by return First Class Mail.

COMPUTER BUDGET SHOPPER (CBS)

2203 Park Ave., Suite 17
Cheyenne, Wyoming 82007
(307) 635-2173

APPLE PUBLIC DOMAIN DISKS

REQUEST FREE CATALOG or send \$2 for sample disk & catalog (RE-FUNDABLE). Categories include education, utilities, games, business, Print Shop graphics, shareware, EAMON and more. Rent for \$1 or buy as low as \$1.50 per disk. \$20 order gets 3 free disks of your choice. NEXT DAY SHIPPING!

CALOKE INDUSTRIES (Dept. SK)
P.O. Box 18477
Raytown, MO 64133

CLASSIFIED

Hardware

EASY HARD DRIVE BACKUP

Backing up Hard Drives and other Large ProDOS storage devices is such a pain, that it usually isn't done. DBack V2.0 will handle the job in just two keystrokes and approximately 8 'Hands Off' minutes (based on 20meg drive to 800k 3.5" floppies). As the last thing you do before shut down each day, it will backup on the files you've used; or any date/date range you specify. Can perform full volume backups, incremental, differential, or specified directories; EASILY! 3.5" (800k) Drive Recommended. Cannot backup files larger than receiving device (will inform you). Extra 'Fun' programs included for FREE! Prints its own Docs. \$25.00/Not Copy Protected

S. BRADLEY MARTIN
RR 3 Box 133
Monmouth, IL 61462

Software

PROJECT MANAGEMENT PLUS

For Apple II+, IIe, IIc, IIc+, IIGS! 64K. EVERYBODY'S PLANNER: the only full-featured project manager for Apple II's. PERT charts have Projects to 5 years, 54 tasks, 216 resources, optional costing, critical path, early & late, start & finish dates, 8 reports and graphs. Included flowchart utility has 19 shapes, 9 sizes, 3 fonts. All for \$99.95! 13 more reports: \$39.95. Enhance above projects with WEL-COME! It creates databases of project milestones, tasks, resources, etc. \$79.95. Special: all 3 programs: \$199! Ck/Visa/MC/Amex/MO

ABRACADATA

PO Box 2440 Dept. DD
Eugene, OR 97402
orders only: 1-800-451-4871
all others: 503-342-3030

SOLITAIRE & CRIBBAGE

Long time favorites, completely revised for the IIGs. Loaded with options. Five versions of Solitaire; Kondike (1 & 3 at a time), Picture Frame, Pyramid, and Monte Carlo. Three versions of Cribbage. Features pull down menus, file save, auto moves, fast pace, change colors, audio on/off, an alarm clock to bring addicted players back to reality, and more. Not copy protected. Requires Apple IIGs-512K, mouse & 3.5 drive. \$34.95 + \$3.00 S/H. Check or Money order. CA res. add sales tax.

COMPUTREK

28278 Enderly Street
Canyon Country, CA 91351
(805) 252-4244

FAMILY ROOTS™

Huge variety and capacity for your family history. Make four kinds of pedigree charts, two descendants charts, two group sheets, Indices address labels, more. Do screen tracing and searches through your data. Numerous variations possible on each form. Interfaces with a word processor. Add-ons available. Call for FREE information. Satisfaction guaranteed! All Apples, Macs, PCs and more. MC/VISA/AMEX

QUINSEPT

P.O. Box 216
Lexington, MA 02173
617-641-2930 (MASS)
800-637-ROOT (US)

ELECTRONIC MUSIC MIDI HELP

A Guide to Computer Music \$16.95 MIDI Starter & ProPacs; Interface, Sequencer, Cables, Music Printing Software from \$99.00 to \$699.00 Apple II, IIe, GS, Mac, Atari, Commodore, IBM, Customized MIDI Systems. MasterTracks \$169.00, Jr. \$109.00, Pro \$199.00, Polywriter \$209.00, Music Tutor \$169.00, Glass Tracks \$89.00, Super Sequencer \$179.00, MIDI Thru Box \$89.00, Studio Plus Two \$185.00, Music Writer GS \$119.00, MIDI Translator GS \$79.00, Hyperstudio GS \$99.00, MIDI Interfaces from \$89.00. Call for catalog and MIDI Librarians.

SOUND MANAGEMENT

P.O. Box 3053
Peabody, MA 01961
Check, MO, Visa, MC, School P.O.
(508) 531-6192 MA
(800) 548-4907 US

RETAIL SUPERVISOR

A retail management system for small business. Point-of-Sale & Inventory Control. Interfaces Bar Code Scanner and Cash Drawer. Prints as well as Reads bar code. Provides detailed & Summary sales reports, inventory value & re-order reports, sales receipts. We handle Scanners, Cash Drawers, Software & Accessories for Retailers. Retail Supervisor™ will help eliminate over stocks, identify slow movers, reduce stock outs, save time & improve profit margins. For detailed info and pricing, call or write today! Apple IIe and IIc compatible.

ABACUS SYSTEMS

707 Cass St.
La Crosse, WI 54601
(608) 785-1740

DIGITIZE YOUR PHOTOS

Put your favorite photos on any hi, double hi, super or ultra res. Apple II screen! Stun friends with personalized slide shows. PET OWNERS: proudly display your cuddly creatures. TEACHERS: Display maps, charts or historical people to help recall. Make your Apple II fun by showing your own digitized pictures, not someone else's. Digitize 4 photos for \$15.00 or 10 for \$30.00. We supply the disk!

Please specify 5.25/3.5, Color or B/W (for best results) and Screen format. Add \$2 S/H. Write for details or send photos along with a check/MO made payable to:

JOSEPH M. NOWAK
c/o: Digital Duplications
1918 W. Church St.
McHenry, IL 60050.

Insurance

INSURE YOUR COMPUTER

Safeware provides full replacement of hardware, media, and purchased software. As little as \$39 a year provides comprehensive coverage. With blanket coverage, no lists of equipment are needed. One phone call does it all! Call 8am to 10pm ET (Sat 9 to 5).

SAFWARE, THE INSURANCE AGENCY INC.
2929 N. High St.
P.O. Box 02211
Columbus, OH 43202
(800) 848-3469 Nat;
(614) 262-0559 (OH)

Use inCider's Classified Section to showcase your Apple II products. Contact Fiona Davies at 1-800-441-4403 for further details.

INSTANT MAESTRO



ELECTRONIC ARTS HAS GOT THE BEAT, and you can hear it in **Instant Synthesizer**. Following Instant Music's lead, this program makes creating music and sound with your Apple IIGS as easy as, well, do-re-mi. As in Instant Music (Editors' Choice, October 1987, p. 144), you can select a recorded tune and play along with the mouse, but with Instant Synthesizer at your fingertips that's just the beginning. Professional musicians or novices can record and edit serious compositions or just jam along and have fun (as *inCider's* editors are known to do).

Get ready to rock 'n' roll or twist 'n' shout—Instant Synthesizer, featuring a four-voice synthesizer, digitizer, and sound editor, turns your GS into a sophisticated studio. The program's main work screen reveals a full mixing-board display with all the options and functions of a "real" synthesizer.

The screen is divided into panels. Its top section contains the song, sound, sequencer, and file areas; running across the center of the screen is the keyboard where you'll see the appropriate "ivories" light up while you play.

The bottom left-hand corner contains four additional panels—synthesizer, effects, envelope, and keyboard map. Select the synthesizer panel to adjust pitch, octave, vibrato depth, speed, volume, and attack rate. Spice up your sound by adding such funky effects as stereo and stereo panning (increasing the volume of one channel or the other), delay and delay panning, vibrato lock, and doubling.

The envelope panel is similar to a piano's bass pedal, letting you alter the volume, sustention, and release of individual sounds and instruments. The map panel shows you a par-

ticular sound's keyboard map—shaded piano keys that combine to play a specific sound (such as a dog's bark) or voices (such as a flute or harp). You can edit the sample and even create multisample sounds. Instant Synthesizer supports sound-sampling boards from MDIdeas and FutureSound, as well as stereo cards for full stereo output.

Instant Synthesizer comes with a data disk of animal sounds (including three different dogs, plus elephant and sheep "voices"), instrument tones, and a variety of prerecorded songs. The quality is good, but to really appreciate the program, get some amplified external speakers such as the Bose Roommates.

If you have a MIDI-capable keyboard (*musical-instrument digital interface*, such as the Casio CZ-101 with which we tested Instant Synthesizer), you can record into the program, then edit, cut, warp, shape, blend, bend—whatever it takes to achieve the desired effect.

Senior Editor Paul Statt says, "This won't make things easier for Apple, given the company's current legal struggle with the Beatles' recording company, but Instant Synthesizer is a welcome addition to the growing roster of music products for the IIGS."

"With Instant Synthesizer," adds Review Editor Lafe Low, "you can make serious music on the IIGS without being a serious musician—or any kind of musician for that matter."

Stay tuned to *inCider's* Reviews section for a full-volume evaluation of Instant Synthesizer in the near future. Listen to Electronic Arts (1820 Gateway Drive, San Mateo, CA 94403, 415-571-7171), and for \$79.95, you can surround yourself with sound. □

EDITORS' CHOICE SINGLES OUT ONE PRODUCT EACH MONTH THAT THE *inCIDER* EDITORS FEEL IS A SIGNIFICANT ADDITION TO THE APPLE II FAMILY OF PRODUCTS. PRODUCTS EVALUATED ARE AMONG THE MOST RECENT RELEASES AND MAY NOT BE AVAILABLE YET FOR RETAIL DISTRIBUTION.

BIG TALKERS



Street Electronics' Echo® products have set the standard for microcomputer voice output for over eight years. Teachers and parents have found that talking software adds a whole new dimension to computer-based learning.

Children not only enjoy the novelty of having their computer talk to them, their attention span is increased, verbal cues and reinforcement keep them motivated as well as assisting non-readers, and learning becomes more personalized and fun.

Although there are a few quality programs which process "software only" voice, it is still necessary to use a dedicated speech add-on peripheral or plug-in board for nearly all of the "talking" educational software. There are over 100 software manufacturers including *Scholastic*, *Optimum Resource/Weekly Reader*, *Houghton Mifflin*, *Hartley Courseware*, *DLM*, *Edmark*, and *Laureate Learning Systems* who presently offer Echo compatible educational and special needs programs, and the number is constantly growing.

Most of the educational programs which are compatible with the Echos take advantage of the high quality female voice output. However, in those programs which require an unlimited vocabulary; for example, a talking word processor, the Echos' text-to-speech capability produces speech in an intelligible robotic-type voice.

The Echos come with a tutorial style manual, an external speaker with a volume control knob and headphone jack, and supporting software. The Echo IIB runs on the Apple® IIe and IIGS, the Echo IIC runs on the Apple IIc and IIc Plus.

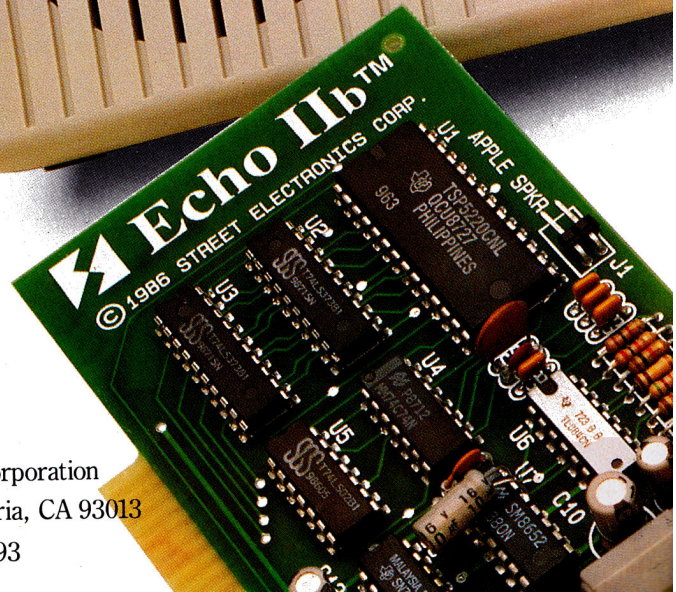
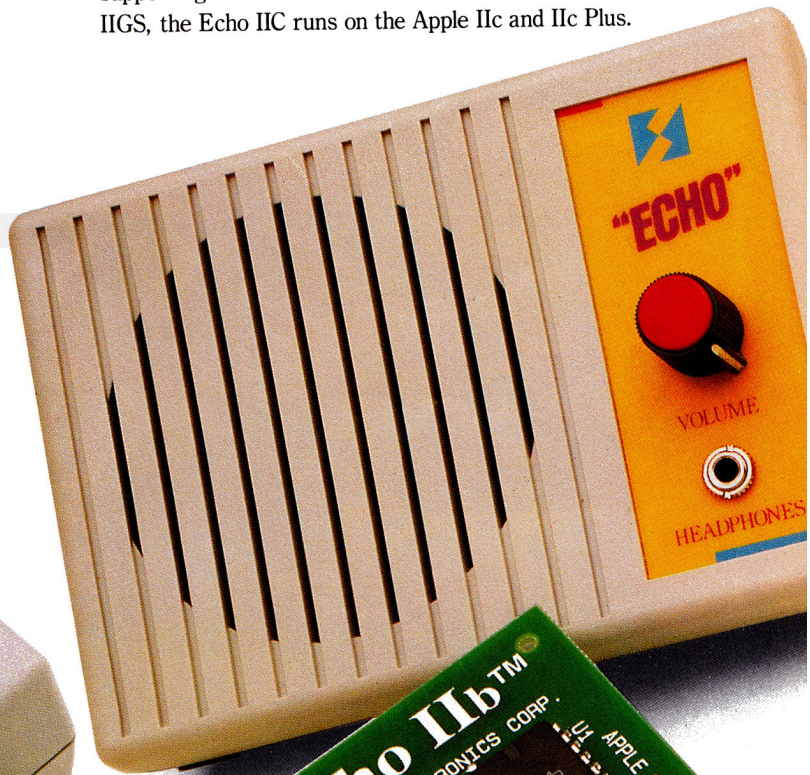

Street Electronics Corporation
6420 Via Real, Carpinteria, CA 93013
(805) 684-4593



System Saver IIGs, \$99.95

*"If it didn't say
Kensington on the
front, you might
think it came
from Cupertino."*

Editors' Choice
inCider magazine



System Saver®, \$89.95

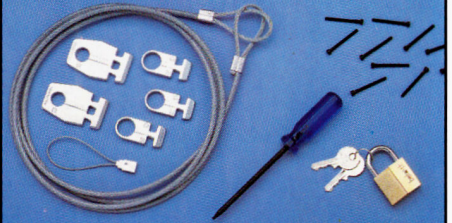

Apple® Security System, \$49.95

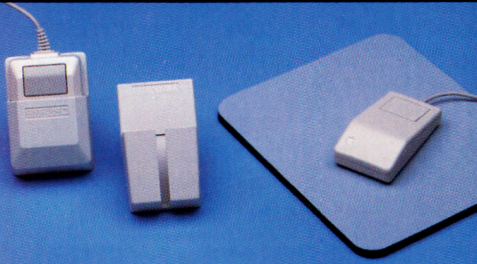

Mouseway, Mouse Pockets, \$9.95 ea.

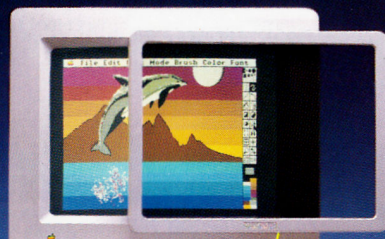

IIGs® Anti-Glare Filter, \$49.95

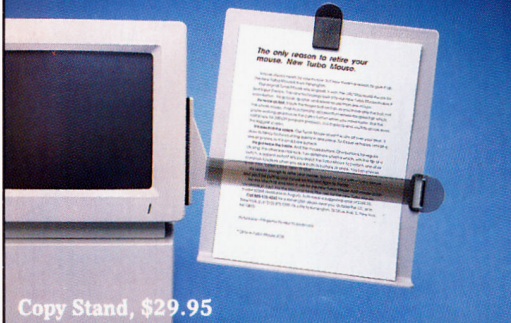

Copy Stand, \$29.95



Turbo Mouse® ADB, \$169.95



Printer Muffler® 80 and Stand,
\$69.95 and \$29.95



Dust Covers, \$9.95 to \$24.95



Universal Printer Stand, \$24.95

That's why inCider magazine named System Saver IIGs Editors' Choice for March '88.

They were impressed at how well its styling blends in with the IIGs. They appreciated the convenience of its front-mounted switches. And they loved the way it offers surge suppression, extra outlets and a cooling fan, all for \$99.95. In summary, they thought it went "a long way toward making the computer easy to use."

Of course, we were delighted with their reaction. After all, making the Apple II easier to use is something we've been working on for the last seven years. In fact, we've figured out so many ways to do it, we can't fit them all on one page.

That's why we've also made it easy for you to get more information. Just call the toll-free number below, and we'll send you a free 20 page brochure. Or write to us at Kensington, 251 Park Ave. S., NY, NY 10010. (212) 475-5200.

Call (800) 535-4242



Setting new standards
of performance.